

# VOCOM II

---

## Operation Instructions

VOCOM II Tough



Revision 2

## Contents

1	About VOCOM II	4
1.1	VOCOM II Configurator	4
1.2	Type plate	5
2	About Operation Instructions VOCOM II Tough	6
2.1	Use and purpose of the Operation Instructions	6
2.2	Safety instructions and warnings	6
2.3	Warranty and liability	7
2.4	Owner's obligations	7
3	For your safety	8
3.1	Proper and intended use	8
3.2	Warnings	8
3.3	Limits of use	9
4	Function	10
4.1	Communication interfaces	10
4.2	Operation modes	14
5	First Time Setup	16
5.1	Installation	16
5.2	Setup	18
6	Update Firmware	26
6.1	Update Firmware reminder	26
7	Configuration	27
7.1	Device list	30
7.2	Perform basic device setup	30
7.3	WLAN configuration	36
7.4	Options menu functions	50
7.5	Status tab	57
7.6	Test tab	57
8	Operation	58
8.1	WLAN mode operation	58
8.2	USB mode operation	59
9	Troubleshooting	60
9.1	Firewall rules	60
9.2	General procedure	60

9.3	VOCOM II error codes	61
10	Maintenance	66
10.1	Care and cleaning	66
10.2	Checks and updates	66
10.3	Repairs	66
10.4	Disposal	67
11	Technical specifications	68
12	Appendix	70
12.1	Specifications	70
12.2	Vehicle communication interfaces	71
12.3	WLAN country settings	72

## 1 About VOCOM II

The VOCOM II communication unit is the latest diagnostic hardware tool developed by Volvo Group for maintenance of trucks, buses, engines and machines.

There are two VOCOM II product variants for use in workshops, Tough variant and "on the truck", Dongle variant. Only the Tough variant is addressed in this document.



Fig. 1-1: Product variants of VOCOM II

---

1 Tough variant

2 Dongle variant

---

### 1.1 VOCOM II Configurator

With the installation of VOCOM II comes the software VOCOM II Configurator.

It is used for setup, gathering of logs and troubleshooting the VOCOM II.

The VOCOM II Configurator is started from Windows Start menu: **Start > All Programs > VOCOM II Configurator.**

## 1.2 Type plate

The type plate is attached to the VOCOM II housing.

The following information is presented on the type plate:

- Article number: AR10009037.
- Hardware revision: Rev. X.
- Production date: ww/jj.
- Serial number (S/N): 71xxxxx, serially numbered, starting with 7100001.
- S/N as C128 bar code.
- MAC address of WLAN interface: nn-nn-nn-nn-nn-nn.

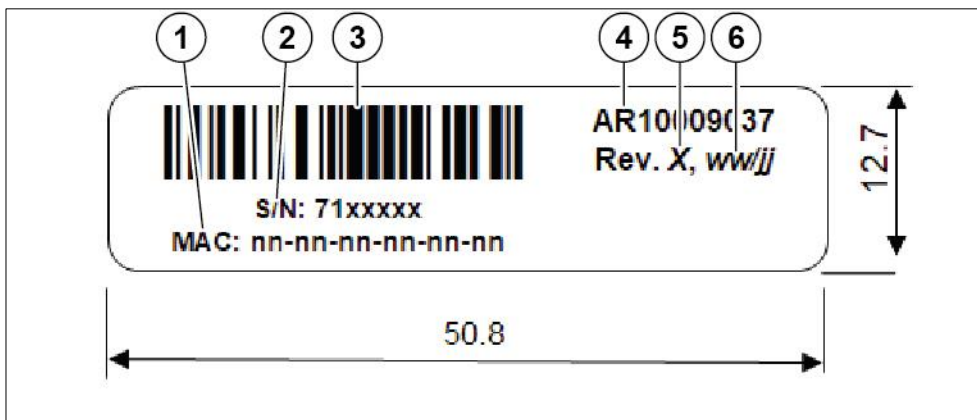

Fig. 1-2 Type plate of VOCOM II

1	MAC address	2	Serial number
3	C128 bar code	4	Article number
5	Hardware revision	6	Production date

## 2 About Operation Instructions VOCOM II Tough

### 2.1 Use and purpose of the Operation Instructions

The Operation instructions are intended for the end user. The Operation Instructions help you:

- To set up and use the product.
- To avoid hazards.
- To prevent downtime.
- To ensure or increase the service life of this product.

Instructions about hazards and safety regulations, as well as the information in the Operation Instructions must be observed without exception. For the proper and safe use of the device, it is vital that you read, understand and apply the Operation Instructions.

### 2.2 Safety instructions and warnings

Chapter 3 For your safety, contains information about the safe use of VOCOM II and the maintenance required to insure the safe state of VOCOM II.

The chapter also contains warning messages for actions that can be hazardous.

#### 2.2.1 Structure of warnings

Warnings are structured as follows:

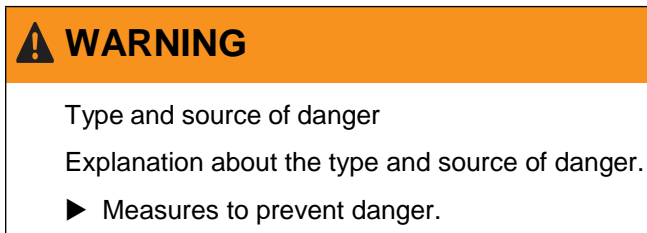

#### 2.2.2 Classification of the warnings

Warning messages are marked with different signal words, symbols and colours depending on the severity of the risk, see explanation below.



## 2.3 Warranty and liability

VOCOM II comes with a 2-year warranty. Volvo Groups Spare Parts Warranty applies.

Warranty and liability claims, for personal and property damage due to one or more of the following causes, are excluded:

- Improper use (see chapter 3.1 Proper and intended use).
- Failure to follow the instructions, dos and don'ts of the Operation Instructions.
- Unauthorised structural changes to VOCOM II.

**Note:** Comply with all applicable legal rules and regulations.

Changes to the device can lead to the loss of the warranty.

To avoid this, comply with the following instructions:

- Do not perform any independent modifications or tamper with the device.
- Only use proper and authorised materials.

## 2.4 Owner's obligations

The owner must:

- Ensure that only persons who have read the Operation Instructions use the device.
- Ensure that the prescribed firmware updates are done when released.

### 3 For your safety

The Operation Instructions provide instructions about safety.

To avoid personal injury, environmental damage or property damage, follow all instructions.

#### 3.1 Proper and intended use

VOCOM II Tough is intended only for maintaining trucks, buses, engines and machines made by Volvo Group. VOCOM II Tough is used for vehicle diagnostic communication in workshops, production facilities and warehouses.

VOCOM II has a life span of up to 15 years, as long as regular maintenance and testing are done to ensure safe operation.

##### 3.1.1 Nonintended use (foreseeable misuse)

Avoid the following listed areas of misuse:

- Opening VOCOM II.
- Careless handling of VOCOM II.
- Careless handling of cables used with VOCOM II.
- Use of defective cables.
- Use of unauthorized cables.
- Exceeding the permissible operating voltage of VOCOM II.
- Use of incorrect regional settings in WLAN mode.
- Use other than under the specified conditions and requirements laid out by the manufacturer in its technical documents, data sheets, assembly, installation and operation instructions and in other specific regulations.

#### 3.2 Warnings

##### NOTICE

Possible material damage due to removal of protectors!

The device and the materials can be damaged if the front protector and WLAN protector are removed during transport.

- ▶ Keep the front protector and WLAN protector fitted on the device when preparing VOCOM II for transport.

##### CAUTION

Risk of slight injuries due to careless handling of cables.

There is risk of slight injuries in case of careless handling of cables used with VOCOM II.

- ▶ Do not pull the cables.
- ▶ Make sure that cables do not run across the floor.



**⚠ WARNING**

Serious injuries due to improper maintenance work!

Improperly performed maintenance work can impair the safety of the device and cause serious injuries.

- ▶ Only allow authorized and instructed personnel to perform maintenance work.

**NOTICE**

Possible material damage due to unsuitable cleaning agents!

Incompatible and aggressive cleaning agents can damage the surface or the components.

- ▶ Only use a moist cloth for cleaning the device.
- ▶ Do not use hard sponges etc.
- ▶ Only use cleaning agents which are compatible with the surfaces and the materials.
- ▶ Do not clean the interior of the device.

### 3.3 Limits of use

Observe the following requirements concerning the operating environment and the infrastructure:

Operating environment/facilities	Limits of use
EX areas (Electrical equipment in hazardous areas)	Not authorized for EX areas
Humidity and temperature	<b>Operation and Transport &amp; storage:</b> <b>75 % humidity at -40°C to +85°C (-40°F to +185°F)</b>

Tab. 3-1: Limits of use of VOCOM II

## 4 Function

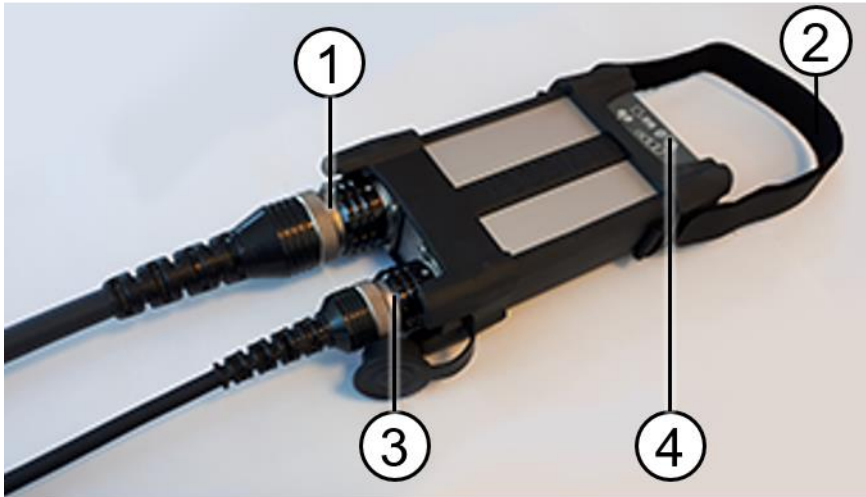

Fig. 4-1: Design of VOCOM II

1	ECTA-26/OBD connector	2	Carry strap with velcro fastener
3	ECTA-12/USB connector with dust cap	4	Plastic cap with function indicators

### 4.1 Communication interfaces

#### 4.1.1 Host communication interfaces

VOCOM II can be used from a host PC (tester) via USB 2.0, USB 3.0 or WLAN (802.11 a/b/g/n).







- For USB connectivity, the VOCOM ECTA-12/USB cable is required.
- The WLAN interface supports 2.4-GHz and 5-GHz operation and can be configured either for WiFi-Direct or **WLAN - Infrastructure** mode. VOCOM II can be also configured as **WLAN - Access Point**.

**Note:** WiFi Direct is a feature for other client platforms (e.g. Android) and should not be used on Windows platforms, since it is not properly supported yet.

### 4.1.2 Function indicators

The device has six function indicators with different colours to indicate the operating statuses and dangers of VOCOM II.

The table below describes the function indicators' symbols, names and what the colours and behaviours of the different LED lamps mean.

Symbol	Indicator name	Description
	Vehicle power	Multicolour LED Green: normal Orange: low/high Red: critically low/high
	PC Link	Multicolour LED Continuous green: USB powered Flashing green: PC Comm activity Continuous orange: Booting Flashing orange: Firmware update
	Warning	Multicolour LED Continuous orange: warning Continuous red: critical error Flashing orange: overtemperature
	WLAN connection	Blue LED Flashing slowly while no WLAN signal bars are lit: Looking for connection Continuous: Connected Flashing fast: WLAN Communication
	WLAN signal	Red bar: WLAN connectivity problem Green bars: signal quality
	Smartcable Connectivity	Green LED Continuous: Smartcable connected

Tab. 4-1: Function indicators of VOCOM II



Fig. 4-2: VOCOM II function indicators in WLAN operation mode

---

<b>1</b> WLAN connection	<b>2</b> PC link
<b>3</b> Vehicle power	<b>4</b> WLAN signal
<b>5</b> ECTA/OBD connector	

---

#### 4.1.2.1 Vehicle power indicator

The If the VOCOM II is connected to a vehicle, it will use the provided power.

Use the Vehicle power indicator to identify the voltage provided.

LED colour	Limits of use
Green: normal	12V system: 12.15V – 16.5V 24V system: 24.3V – 28V
Orange: low	12V system: 11.6V – 12.15V 24V system: 23.2V – 24.3V
Red: critically low	12V system: 6.0V – 11.6V 24V system: 16.6V – 23.2V

Tab. 4-2: Vehicle power indicator levels

#### 4.1.3 Reset button

The Reset button for Factory Reset is integrated into the front protector. Hold the Reset button for 5 seconds to reset the device to factory defaults:

- Device name
- Paired client
- WLAN configuration

**Note:** Resetting the device does not revert the firmware version.

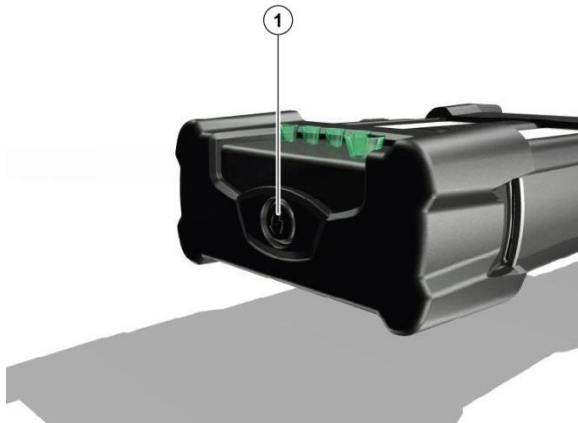

Fig. 4-3: Reset button of VOCOM II

---

#### 1 Reset button

---

## 4.2 Operation modes

VOCOM II is designed and constructed for use in the following operation modes:

- WLAN operation mode
- USB operation mode

### 4.2.1 WLAN operation mode

**Note:** In WLAN operation mode, VOCOM II is powered via OBD.

The WLAN operation status of VOCOM II is indicated by the following function indicators:

- PC link (green LED, laptop symbol)
- WLAN connection (blue LED, antenna symbol)
- WLAN signal (green LED, bar graph)

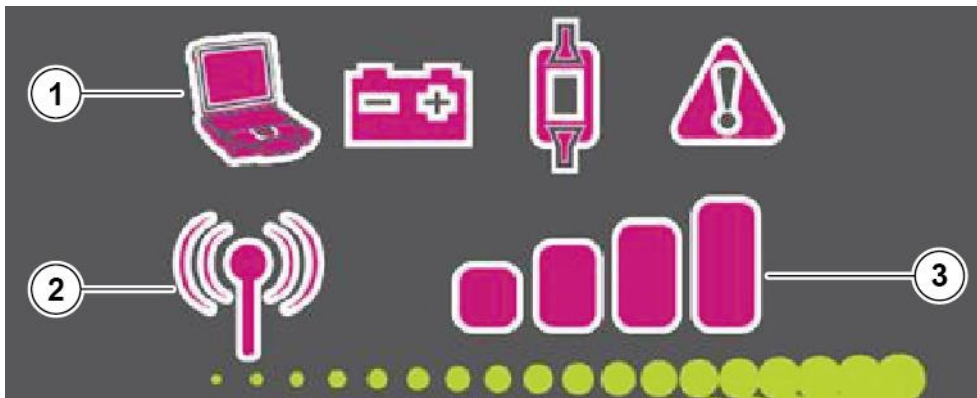

Fig. 4-4: VOCOM II front label with function indicators

1 PC link

2 WLAN connection

3 WLAN signal

- If the WLAN interface is active, the WLAN connection LED will be ON.
- If WLAN connection has been established, the WLAN connection LED will be constantly ON, flashing in case of RX/TX activity. The WLAN signal LED (bar graph), will indicate the signal strength.
- If no WLAN connection has been established, the WLAN connection LED will blink with a period of approximately 1 second and the WLAN signal LED bar graph will be OFF (signal strength is 0).
- In case of RX/TX activity, the PC link LED will flash.
- The vehicle battery status is indicated by the Vehcial power LED.
  1. Normal battery state (12/24-V operation) is indicated by green colour.
  2. Low battery states are indicated by yellow (low) and red colour (critical).

### 4.2.2 USB operation mode

**Note:** In USB operation mode, VOCOM II is powered via OBD (primarily) or USB.

Fig. 4–5 shows the typical function indicator state of VOCOM II in USB operation mode.



Fig. 4–5: VOCOM II function indicators in USB operation mode

1	PC Link	2	Vehicle power
3	ECTA/USB connector	4	ECTA/OBD connector

The USB operation status indication is as follows:

- The PC link LED shines green when the device is powered via USB.
- The PC link LED is flashing during RX/TX activity.
- The vehicle battery status is indicated by the Vehicle power LED.
  1. Normal battery state (12/24-V operation) is indicated by green colour.
  2. Low battery states are indicated by yellow (low) and red colour (critical).

## 5 First Time Setup

### 5.1 Installation

Connect the VOCOM II device to the USB port of the PC. The device is ready to communicate when the PC link LED shines green.

When connecting a new VOCOM II device for the first time, the Windows device driver setup will run:



Fig. 5-1: Installing device

**Note:** When connecting a VOCOM II device for the first time, the device installation could take several minutes due to the Windows specific “driver installation” feature.

The installation progress and remaining time are displayed during the installation.

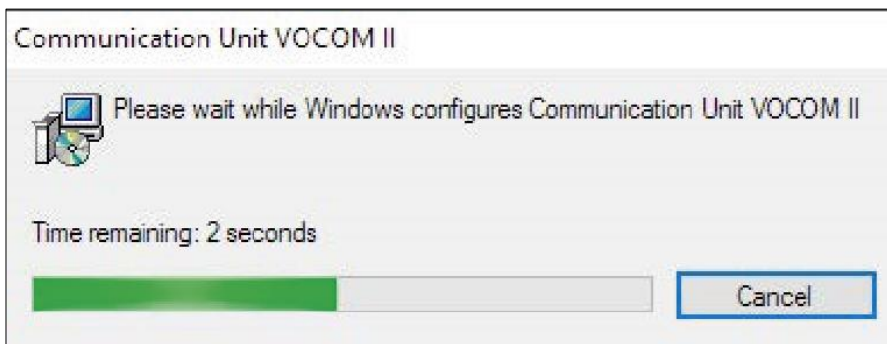

Fig. 5-2: Startup screen of the VOCOM II Windows installer

If the device driver installation has been successfully completed, a task bar notification will be shown:



Fig. 5-3: Device ready to use



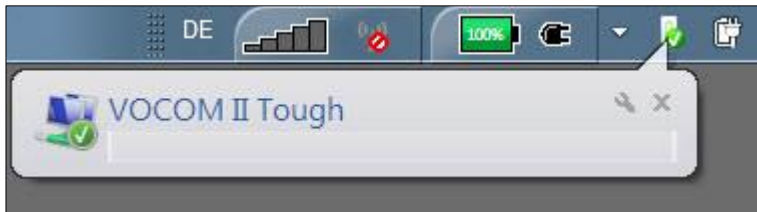

Fig. 5-4: Device installed

If for some reason the device driver fails to install, try again by disconnecting VOCOM II from the USB port and connecting it to a different USB port, or by restarting the computer.

### 5.1.1 Automatic Firmware Update

After installing the VOCOM II to the computer, an automated firmware update will launch.

**Note:** Make sure that Tech Tool (or similar programs) has been turned off.

When the firmware update starts, the VOCOM icon in the Configurator will turn yellow and status will change to updating.

A small window (see below) will open and show the progress of the update.

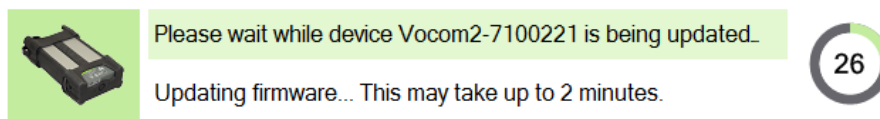

Fig. 5-5: Automatic firmware updating

When the firmware is finished, the device will reboot itself. Wait a couple of seconds to make sure that an FPGA update is not necessary.

The following windows will pop up in case of an FPGA update.

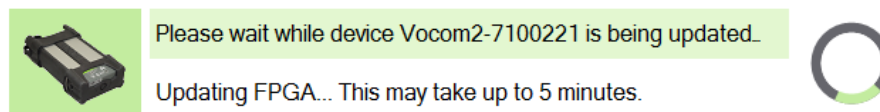

Fig. 5-6: Automatic firmware updating

## 5.2 Setup

Follow these steps to set up your VOCOM II after finishing the installation.  
For further details on configurations, check chapter 7.

### 5.2.1 USB Setup

After a successful installation, there will be no need to perform any setup.

- 1 Connect the VOCOM II to USB.
- 2 Start Tech Tool and wait for it to identify the VOCOM II.

### 5.2.2 WLAN Setup

*WLAN includes WIFI.*

VOCOM II Configurator is needed for setting up WLAN communication.

The VOCOM II Configurator is started from Windows Start menu: **Start > All Programs > VOCOM II Configurator.**

There are two WLAN communication modes; **WLAN - Access Point** and **WLAN - Infrastructure.**

**WLAN** is used when connecting directly to the VOCOM II. This mode is typically used in the field.

**WLAN - Infrastructure** is used when both the computer and the VOCOM II connect to the same network. This mode is most suitable for workshops.

**5.2.2.1 WLAN - Access Point**

**WLAN - Access Point** is used when the computer is connected directly to the VOCOM II. This means that there will be no direct internet access while connected to the VOCOM II.

Follow these steps to set up **WLAN - Access Point**.

- 1 Make sure Tech Tool is not running.
- 2 Connect VOCOM II to USB.
- 3 Launch the VOCOM II Configurator.

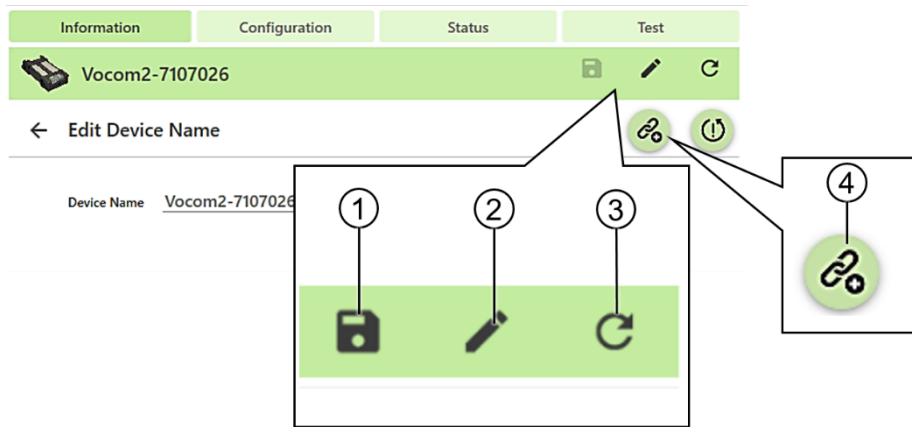

Fig. 5-7: Name of menu bar buttons

1	Save	2	Edit
3	Restart	4	Pair

- 4 Click **Edit**.
- 5 Click **Pair**.
- 6 Insert a Client Name (for example the name of the computer) in the pop-up window.
- 7 Click **Pair** in the popup window. The VOCOM II is now paired to this computer.
- 8 Click on the **Configuration** tab.
- 9 Select the **Connection type: WLAN - Access Point**.



Fig. 5-8: Connection Type WLAN - Access Point

- 10 Set your preferred **Network Settings**:

- **Network Name:** Name that the VOCOM II will send out. This will be the name of the network you connect to. Default Network Name is “Vocom2T\_[serial number]”.
- **Password:** Preferred password of VOCOM II network. Default password is “v2t[serial number]”.

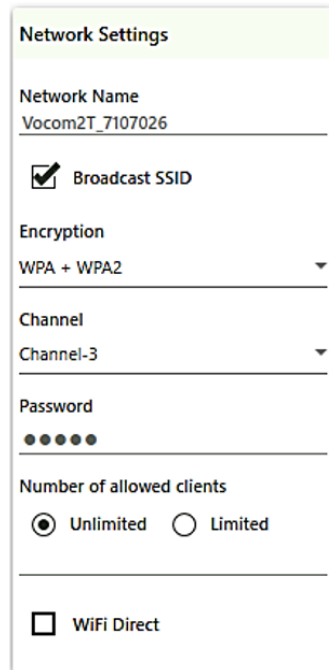

Fig. 5-9: Example of network settings

- 11 Click **Save**, to save the settings.
- 12 Disconnect the VOCOM II from USB.
- 13 Connect the VOCOM II to a vehicle (don't connect to USB).
- 14 Select the VOCOM II network and connect to it.
- 15 Click the **network** symbol on the lower right-hand side of the taskbar.



Fig. 5-10: Windows taskbar with the network symbol marked.

- 16 Select the VOCOM II's network and enter the selected **Password**.

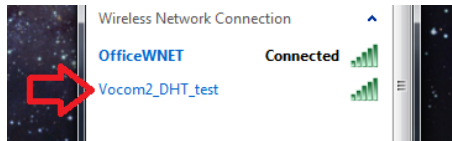

Fig. 5-11: The VOCOM II network from the example.

- 17 On Windows 10 and later Windows versions, the messages “Enter the PIN on the router label” can appear.  
In that case click “Connect using a security key instead”.

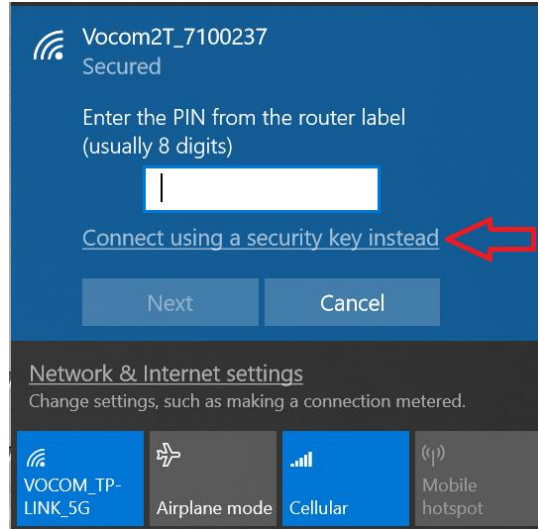

Fig. 5–12: Connecting using Windows 10.

Then enter your chosen **Password**.

**18** You should now be able to see the VOCOM II in the configurator again.

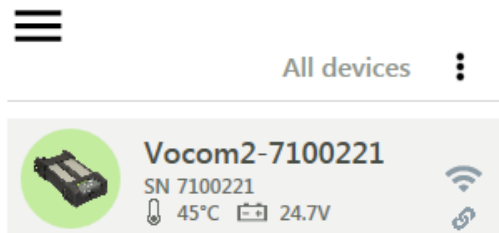

Fig. 5–13: VOCOM II connected via WLAN - Access Point.

**19** You are now connected to the VOCOM II through **WLAN - Access Point**

### 5.2.2.2 WLAN - Infrastructure

**WLAN - Infrastructure** is used when both the computer and the VOCOM II connect to the same network.

**WLAN - Infrastructure** is most suitable for workshops, where a connection to the Internet is necessary and the added mobility is beneficial.

The following instructions will help you with the setup of a single router network. For bigger networks, contact your IT support for help with the setup.

Before starting, make sure that the router comply with 802.11 a/b/g/n (works with most modern routers) and that you have access to the routers login credentials.

- 1 Make sure Tech Tool or similar programs are not running.
- 2 Connect the computer to the routers network.
- 3 Connect the VOCOM II to the computer and launch the VOCOM II Configurator.

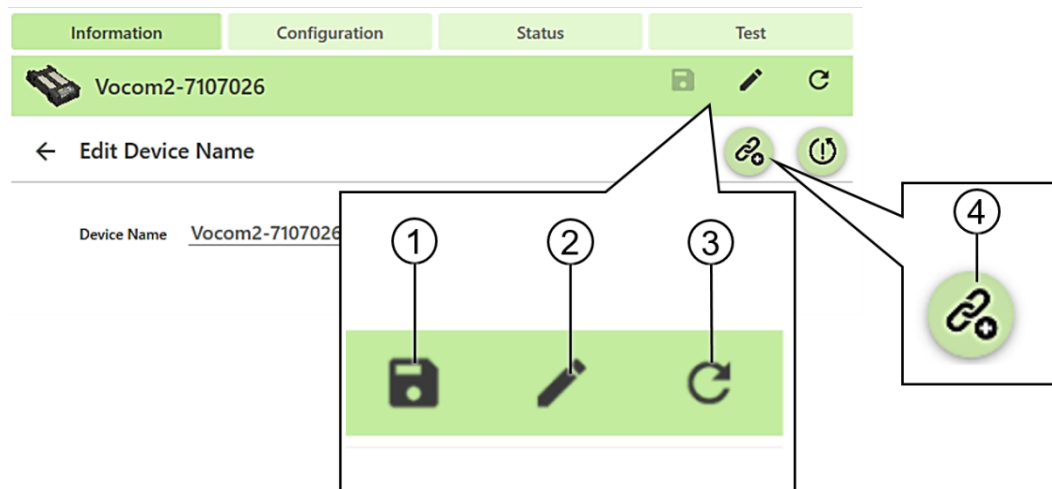

Fig. 5–14: Name of menu bar buttons

1	Save	2	Edit
3	Restart	4	Pair

- 4 Click **Edit**.
- 5 Click **Pair**.
- 6 Insert a Client Name (for example the name of the computer) in the popup window.
- 7 Click **Pair** in the pop-up window. The VOCOM II is now paired to this computer.
- 8 Click on the **Configuration** tab.
- 9 Select the **Connection** type: **WLAN Infrastructure**.



Fig. 5-15: Connection Type WLAN - Infrastructure

**10** Under **WLAN Configuration** you can choose the network your computer is connected to.

It will then automatically fill in some fields like **Encryption** and **Authentication**.

**11** Set your preferred **Network Settings**:

- **Network Name:** Name of your network.
- **Encryption:** The encryption used by the network.
- **Authentication:** The authentication used by the network  
If you are using EAP-PEAP or EAP-TLS you will need to add a certificate. For more information, check section **Installing a certificate**.
- **User name:** The user name used to connect to the network (ignore if greyed out).
- **Password:** The password used to connect to the network (ignore if greyed out).

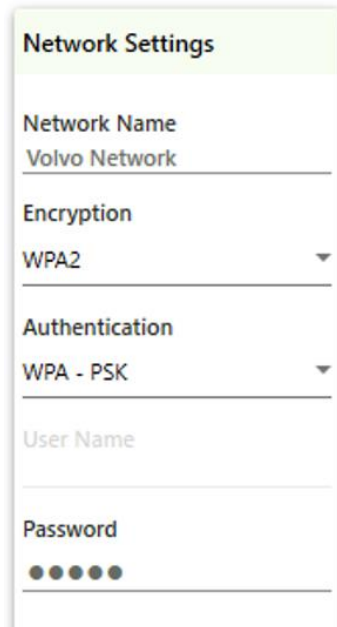

Fig. 5-16: Example of network settings

**12** Click **Save** to save the settings.

- 13 Disconnect the VOCOM II from USB.
- 14 Connect the VOCOM II to a vehicle (don't connect to USB).
- 15 Look at the green bars for WLAN signal strength. If the WLAN connection LED is blinking instead it means that the VOCOM II could not connect to the network. Connect to USB and check that the settings are correct.
- 16 You should now see the VOCOM II in the Configurator again.

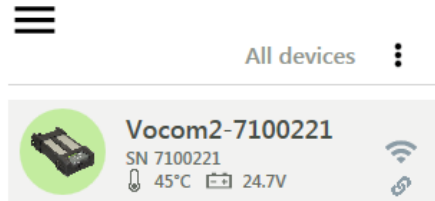

Fig. 5–17: VOCOM II connected via WLAN Infrastructure.

- 17 You are now connected to the VOCOM II through WLAN.

**Installing a certificate**

To install the **EAP-TLS/PEAP** certificate, follow these steps.

- 1 Click on the three dots. Select the location of the certificate you want to install. Then press install.

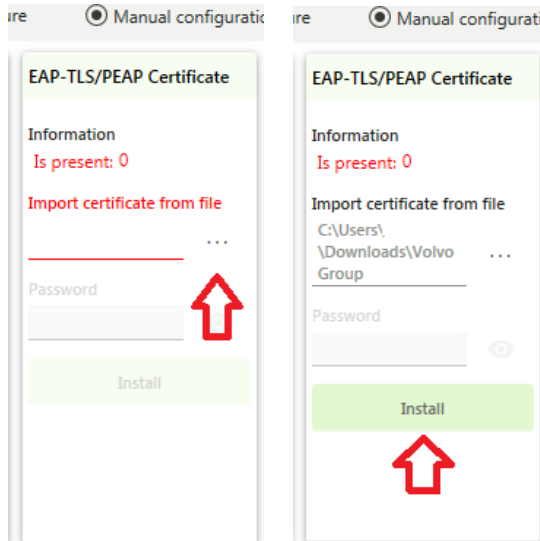

Fig. 5–18: How to install a certificate



2 The **EAP-TLS/PEAP Certificate** will now look something like this.

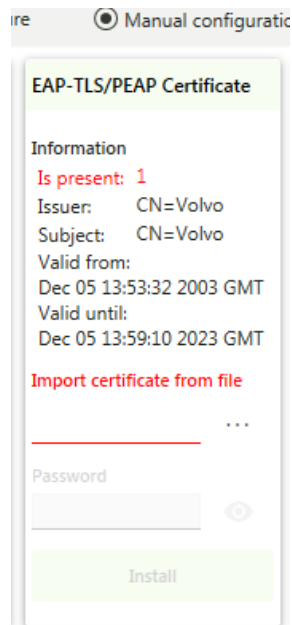

Fig. 5–19: Example of how it can look with an installed certificate.

## 6 Update Firmware

The firmware on the VOCOM II is automatically updated if a new version is available in Client Update.

If you have updated the VOCOM 2 DRIVER in Client Update, check if there is an automated update available by doing the following.

- Make sure Tech Tool has been turned off.
- Connect the VOCOM II you want to update.

If an update is being installed, the following should appear.

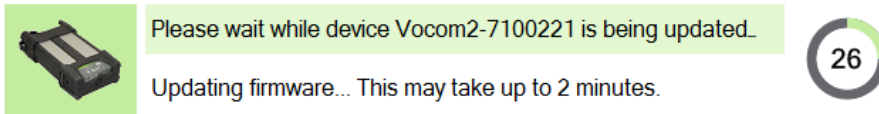

Fig. 6-1: Automated update of VOCOM II in progress.

Wait until the update is complete and the VOCOM II has performed a restart.

### 6.1 Update Firmware reminder

A reminder to update firmware is displayed if one of two situations prevents the automated firmware update.

- The VOCOM II is connected via WLAN. - To start the firmware update, connect the VOCOM II via USB.
- A diagnostic application is running (Tech Tool, Vodia, etc.). - To start the firmware update, close the application that uses the connected VOCOM II.

The recommendation is to immediately take action to update the firmware. If that is not possible, the pop-up reminder allows you to set a time for a new reminder.

## 7 Configuration

The VOCOM II Configurator provides all features necessary to configure and update VOCOM II devices.

The VOCOM II Configurator is started from Windows Start menu: **Start > All Programs > VOCOM II Configurator.**

For each available VOCOM II device, there is a single device list entry containing information regarding:

- Product Variant
- Serial Number
- Connection Type (USB symbol, WLAN symbol)
- Pairing status
- Device status

Each VOCOM II device available, will be listed on the **Device list** that is always visible at the left-hand side of the application.

**Note:** The **Information** tab is the default tab when opening the application or when selecting another device in the list.

**Note:** The **Device list** is continuously updated and will update the connection type as they change or show new devices as they become available.

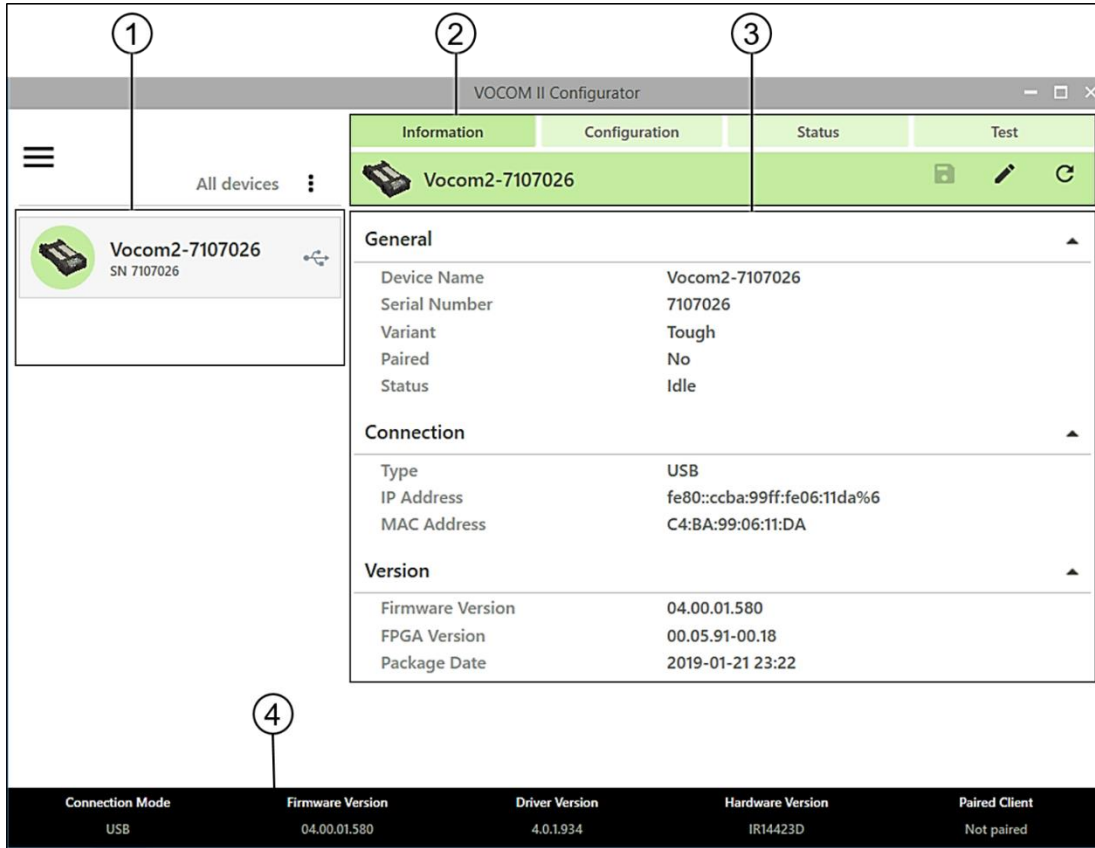

Fig. 7-1: VOCOM II Configurator main window

- |  |   |
|--|---|
| <p><b>1</b> Device list</p> <p><b>3</b> Menu bar</p> | <p><b>2</b> Configuration page</p> <p><b>4</b> Info bar</p> |
|--|---|

The main window components are the **Device list** (1) to the left, the **Info bar** (4) at the bottom, the **Menu bar** (2) at the top and the Information page (3) in the middle right.

The **Info bar** shows information about the software version and connection mode of the selected device. The Information page displays content from the currently selected device.

The four main configuration pages are **Information**, **Configuration**, **Status** and **Test**, these can be reached via their corresponding **Menu bar** tabs.

To save configuration changes and reboot the device, use the **Save** and **Reboot** buttons on the **Menu bar**.

The **Edit** button opens the configuration page for basic device setup, factory reset and device pairing.

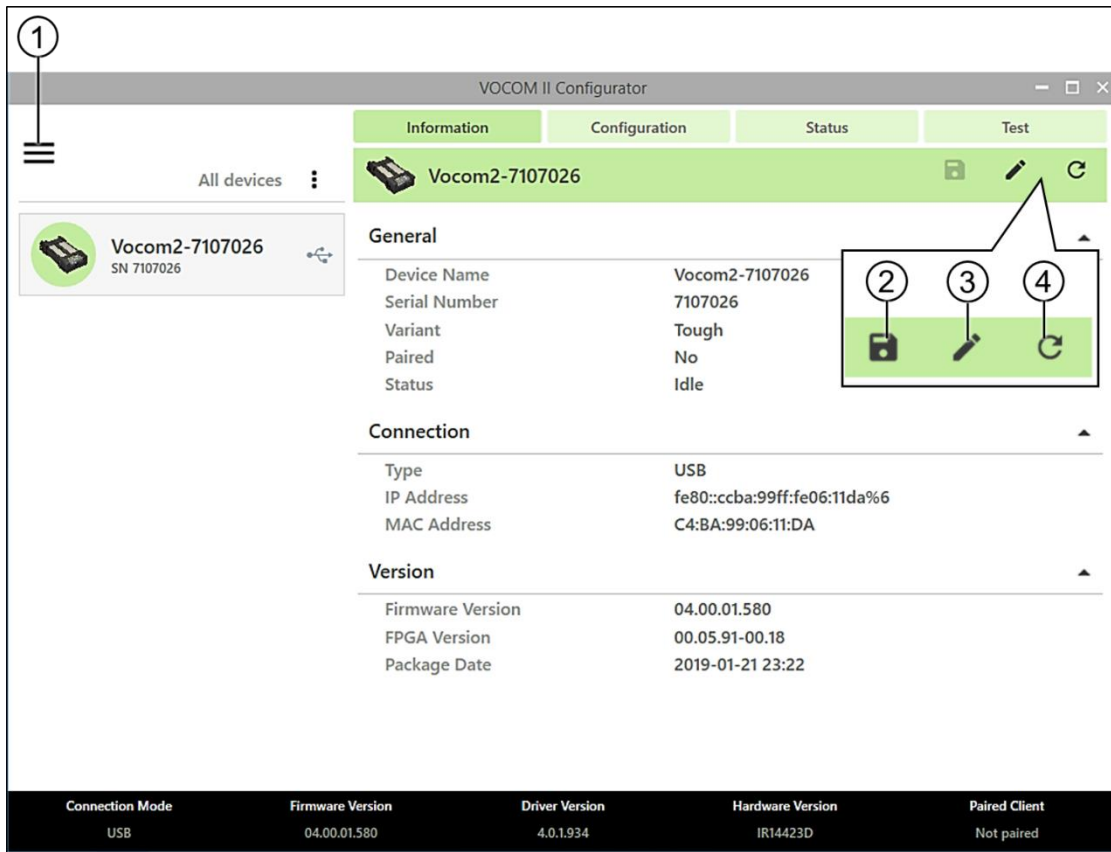

Fig. 7-2: Options menu, Save, Edit and Reboot buttons

- |                |                 |
|----------------|-----------------|
| 1 Options menu | 2 Save button   |
| 3 Edit button  | 4 Reboot button |

More VOCOM II Configurator features can be accessed from the **Options** menu in the upper left-hand corner, above the **Device list**. Among those features is the Help function, the **Language settings**, the **Log Configuration** dialog and the **Device mapping** dialog. For more information see chapter 7.4 Options menu functions.

## 7.1 Device list

The Device list of the VOCOM II Configurator contains the currently connected VOCOM II devices.

A single mouse click on a Device list entry will change the device content of the Info bar and the Information page view.

A double mouse click on a Device list entry will select this device as default device.

The currently selected default device is indicated by a green check mark.

Fig. 7–3 shows examples of Device list entries for different device variants and states.

If the VOCOM II is connected to a vehicle, it will also show internal temperature and battery voltage.

When the VOCOM II is paired to the computer, it will be indicated with a small link symbol below the WLAN symbol.



Fig. 7–3: Device list entries

1	Tough variant, Idle status	2	Selected default device
3	Tough variant, busy status	4	Name and serial number
5	USB connection	6	WLAN symbol

## 7.2 Perform basic device setup

To open the VOCOM II Configurator, click **Edit** from the **Menu** bar and perform the basic device setup. In the basic VOCOM II device setup you can do the following:

- Change the **Device Name**.
- Pair the device with the local PC.
- Reset the device configuration to factory settings.

## 7.2.1 Change Device Name

You can change the **Device Name** of your VOCOM II device in the basic device setup configuration page.

To change the **Device Name** of your VOCOM II device, perform the following steps:

- 1 Click **Edit** from the **Menu** bar.
- 2 Change the **Device Name**.
- 3 Click **Save**.

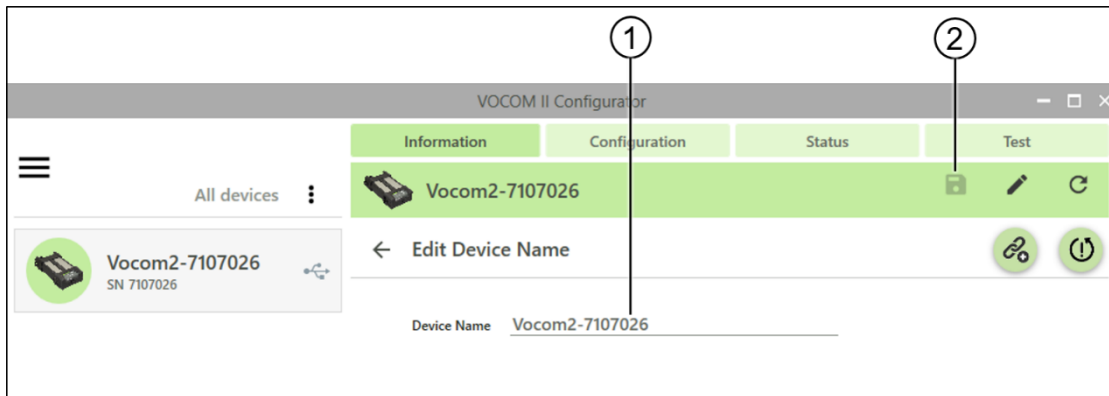

Fig. 7-4: Changing the Device Name

1 Device Name

2 Save button

- 4 Click **Reboot**.

The new **Device Name** is updated in the corresponding Device list entry and Information page.

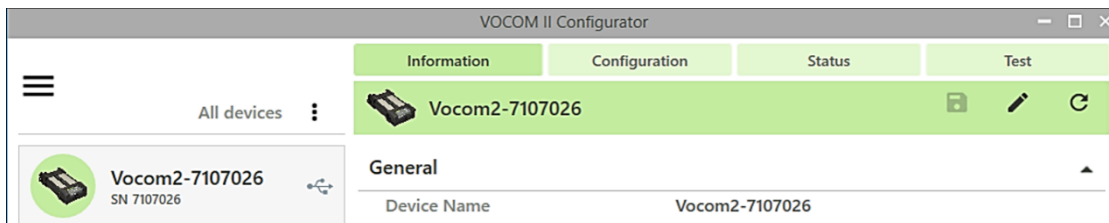

Fig. 7-5: Changing the Device Name

## 7.2.2 Pair with local PC

Pairing is a prerequisite for WLAN usage.

The following tasks can only be performed if the VOCOM II device is paired:

- Diagnostic communication via WLAN.
- Firmware update via WLAN.
- Changing the device settings via WLAN.

**Note:** After a factory reset, the pairing is lost.

**Note:** To pair a VOCOM II device, you have to connect it to the client PC via USB.

To pair a VOCOM II device, perform the following steps:

- 1 Click the **Edit** button in the **Menu** bar.
- 2 In the Configuration page, click the **Pair** button.

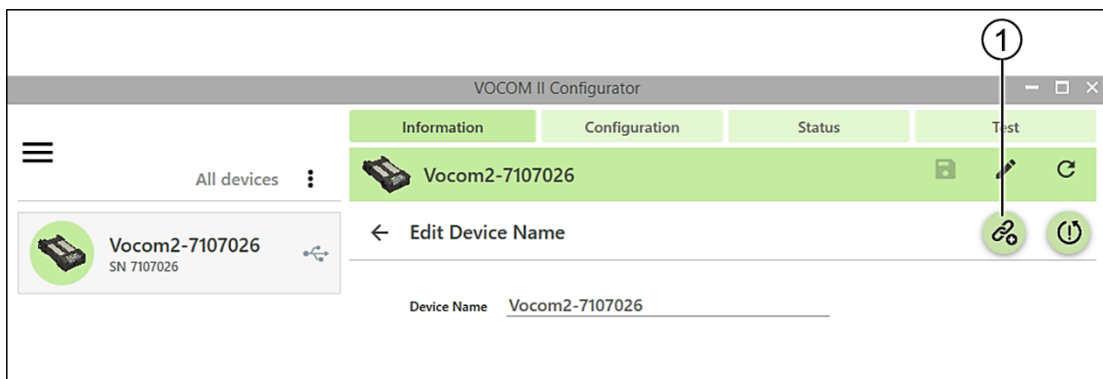

Fig. 7-6: Pairing a VOCOM II device with a client PC

---

### 1 Pair button

---



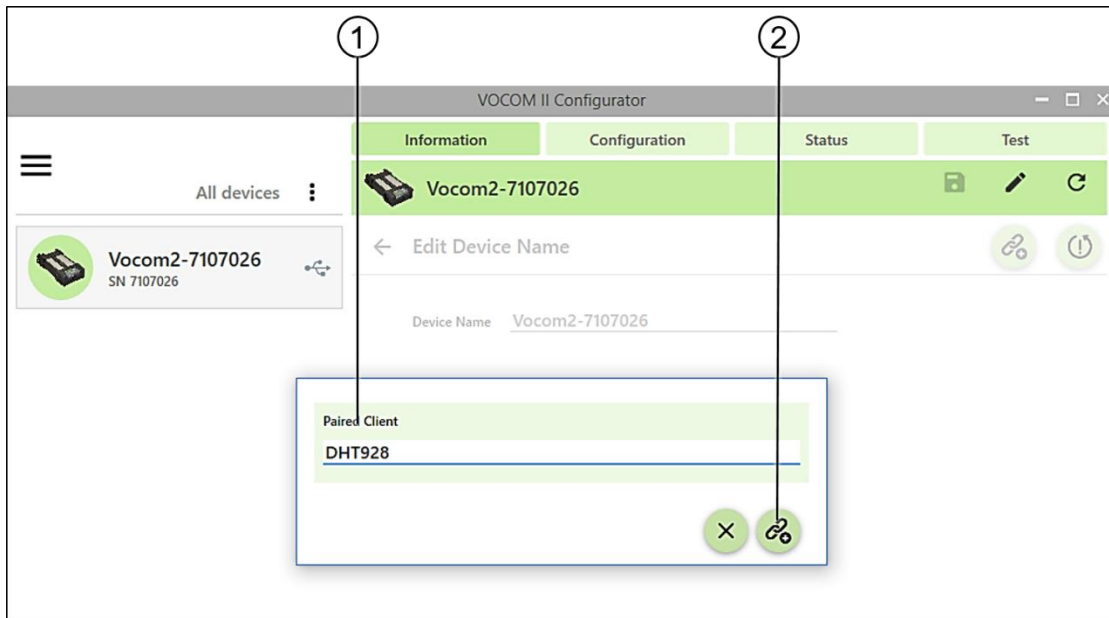

Fig. 7-7: Pairing a VOCOM II device with a client PC

**2** Client Name

**3** Pair button

- 1** In the **Pairing** dialog, enter a name (**Client Name**) to be displayed in the **Info** bar.
- 2** In the **Pairing** dialog, click on the **Pair** button.

**Note:** The currently paired computer is always displayed in the **Info** bar in the **Client ID** field.

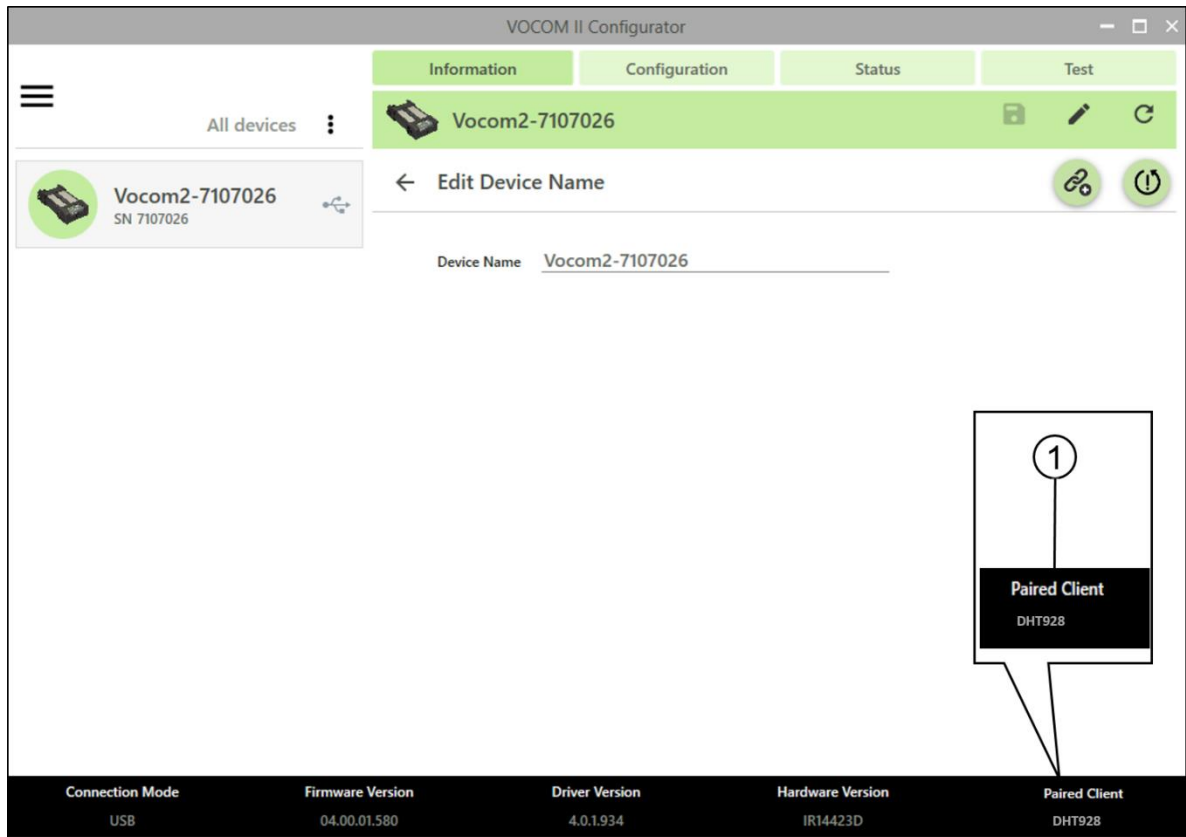

Fig. 7–8: Pairing a VOCOM II device with a client PC

---

**1** Client ID

---

### 7.2.3 Perform a factory reset

A factory reset will revert the VOCOM II device configuration to its original state and restore the factory default settings.

**Note:** A factory reset can only be performed when the VOCOM II is connected via USB.

To perform a factory reset, perform the following steps:

- 1 Click **Edit** from the **Menu** bar.
- 2 In the Information page, click **Factory Reset**.
- 3 Confirm the factory reset.
- 4 **Reboot** the device.

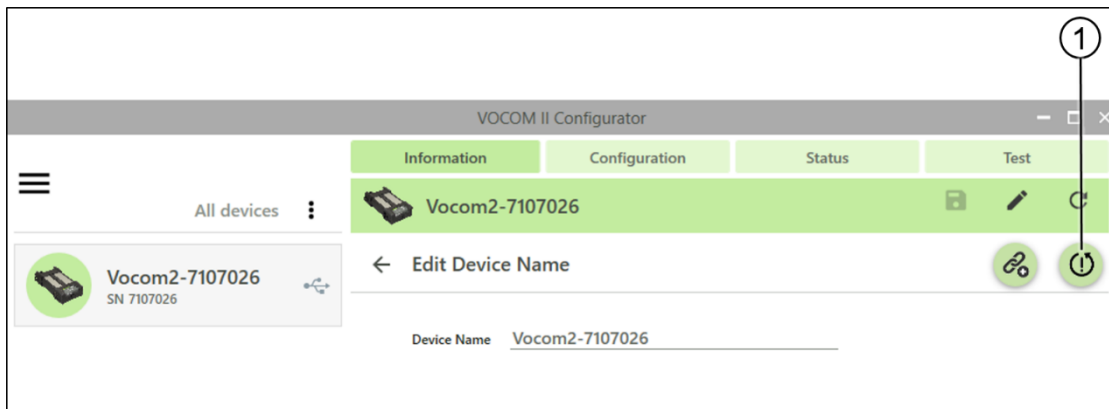

Fig. 7-9: Performing a factory reset

- 1 Factory Reset button

### 7.3 WLAN configuration

**Note:** Make sure that the VOCOM II is connected via USB and is ready to operate.

Open the VOCOM II Configurator and perform the WLAN configuration. To open the WLAN configuration page of a particular device, perform the following steps:

- 1 From the Device list, select the VOCOM II device you want to configure for WLAN operation.
- 2 Click Configuration in the Menu bar.
- 3 The WLAN Configuration page will be shown:
  1. The **WLAN - Infrastructure** mode is normally used in a workshop environment where there is already an existing infrastructure network.
  2. The **WLAN – Access Point** mode is used when the laptop need to be directly connected to a VOCOM II device via WLAN, e.g. when using it in the field without access to an infrastructure network.

**Note:** WiFi Direct is a feature for other client platforms (e.g. Android) and should not be used on Windows platforms, since it is not properly supported yet.

**Note:** WLAN configuration changes will only take effect after rebooting the device.

After configuring the VOCOM II WLAN interface and rebooting the device, unplug the USB cable. Make sure the VOCOM II is powered from ECTA/OBD connector.

- The Vehicle power indicator (battery symbol) should shine green.
- The WLAN connection indicator (antenna symbol) should shine blue.
- The WLAN signal strength indicators (LED bar) should be lit.

When WLAN connection has been successfully established, the WLAN signal strength is indicated by the 4 LED bars.

WLAN RX/TX activity is indicated by flashing WLAN connection and PC Link indicators, if Vehicle traffic is on-going.

### 7.3.1 WLAN - Access Point Mode

**Note:** Before using the VOCOM II device in **WLAN - Access Point** mode, make sure that it is paired with your PC. See chapter 7.2.2 Pair with local PC.

**WLAN – Access Point** is the default VOCOM II WLAN mode. **WLAN – Access Point** mode only supports operation in 2.4-GHz band. The default **WLAN – Access Point** settings are as follows:

WLAN mode/connection	Access Point
Network name	Vocom2T_[serial number] Example: Vocom2T_7100133
Broadcast SSID	Yes
Password	v2t[serial number] Example: v2t7100133
Encryption	WPA + WPA2
Channel	3
IPv4 address	192.168.51.1/24
Activate DHCP server	Yes
IPv4 address range	192.168.51.101 - 192.168.51.149

Tab. 7-1: WLAN – Access point default settings

Fig. 7–10 shows the **WLAN – Access Point** configuration page with default settings.

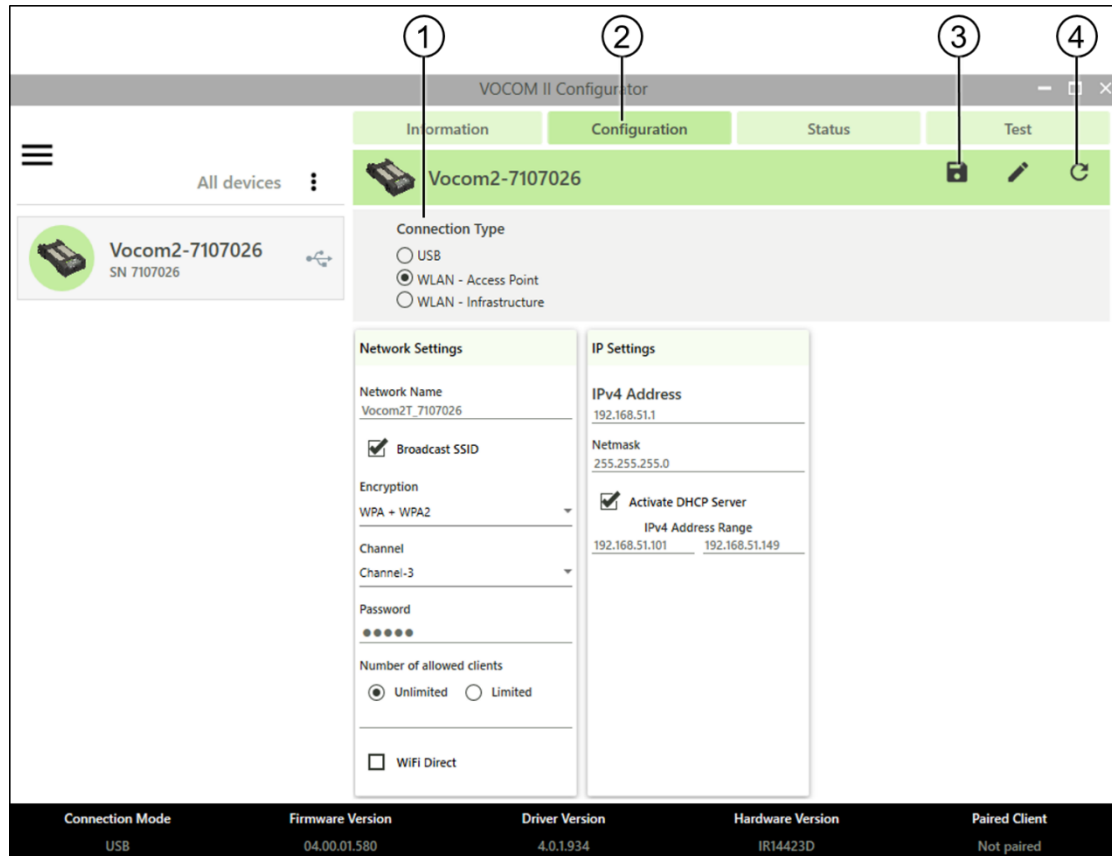

Fig. 7–10: WLAN - Access Point configuration page

- |   |   |
|---|---|
| <p>1 Connection Type panel</p> <p>3 Save button</p> | <p>2 Configuration tab</p> <p>4 Reboot button</p> |
|---|---|

To change the **WLAN - Access Point** configuration, perform the following steps:

**Note:** When changing the IPv4 settings, make sure that the following conditions are met:

- IPv4 Address and Netmask are consistent.
- If Activate DHCP Server is enabled, the DHCP IPv4 address range must belong to the same network as the chosen IPv4 address.

- 1 Click **Configuration** from the **Menu** bar.
- 2 Select **WLAN - Access Point** in the Connection Type panel.
- 3 Change the VOCOM II Access Point settings according to your needs.
- 4 Click **Save**.
- 5 Click **Reboot**.

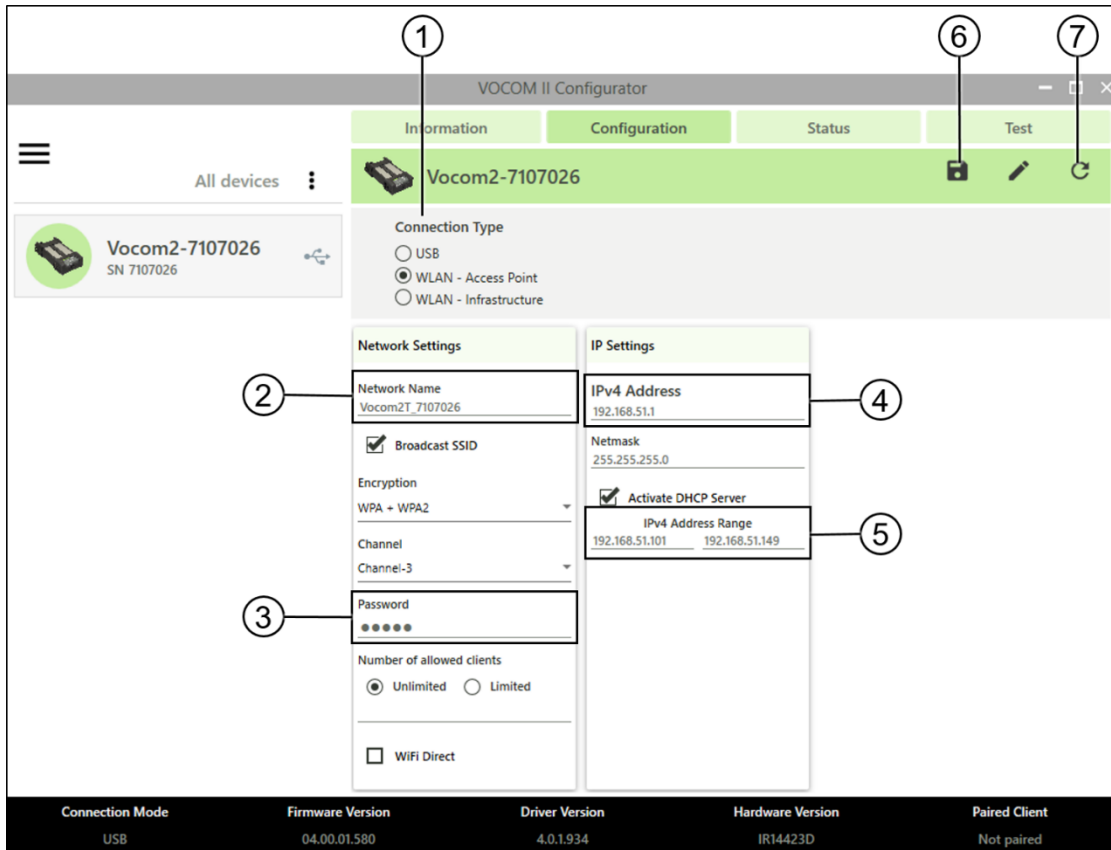

Fig. 7-11: Changing the WLAN - Access Point configuration

- |   |                       |   |              |
|---|-----------------------|---|--------------|
| 1 | Connection Type panel | 2 | Network Name |
| 3 | Password              | 4 | IPv4 Address |
| 5 | IPv4 Address Range    | 6 | Save button  |
| 7 | Reboot button         |   |              |

7.3.2 WLAN Infrastructure Mode

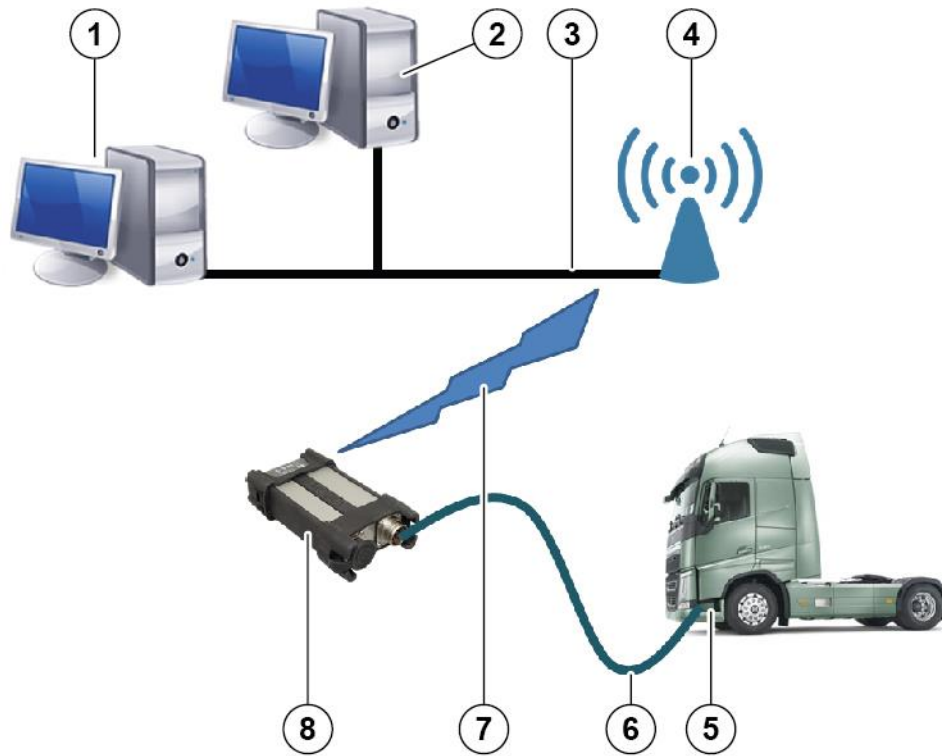

Fig. 7-12 WLAN - Infrastructure mode description

1	PC in LAN using VOCOM II	2	PC in LAN not using VOCOM II
3	(Local Area Network) LAN	4	Enterprise Wi-Fi router in the LAN
5	Vehicle connected to VOCOM II	6	Vehicle cable
7	VOCOM II connected to Enterprise Wi-Fi Router	8	VOCOM II



In the Configurator's WLAN Configuration page, select **WLAN - Infrastructure** in the **Connection Type** panel.

**Note:** Selecting **Available Wireless Networks** in **WLAN configuration** pre-sets the network name (SSID), authentication type, encryption method, IP address settings and country from the active network setting of the wireless NIC of the client.

- 1 Enter the name of your WLAN network (i.e. the SSID of the existing network) into the **Network Name** field of the WLAN Infrastructure Configuration panel.
- 2 From Encryption and Authentication menus, select a combination of encryption-methods and WLAN-authentication methods that is supported by your network.
- 3 Click **Save**.
- 4 Click **Reboot**.

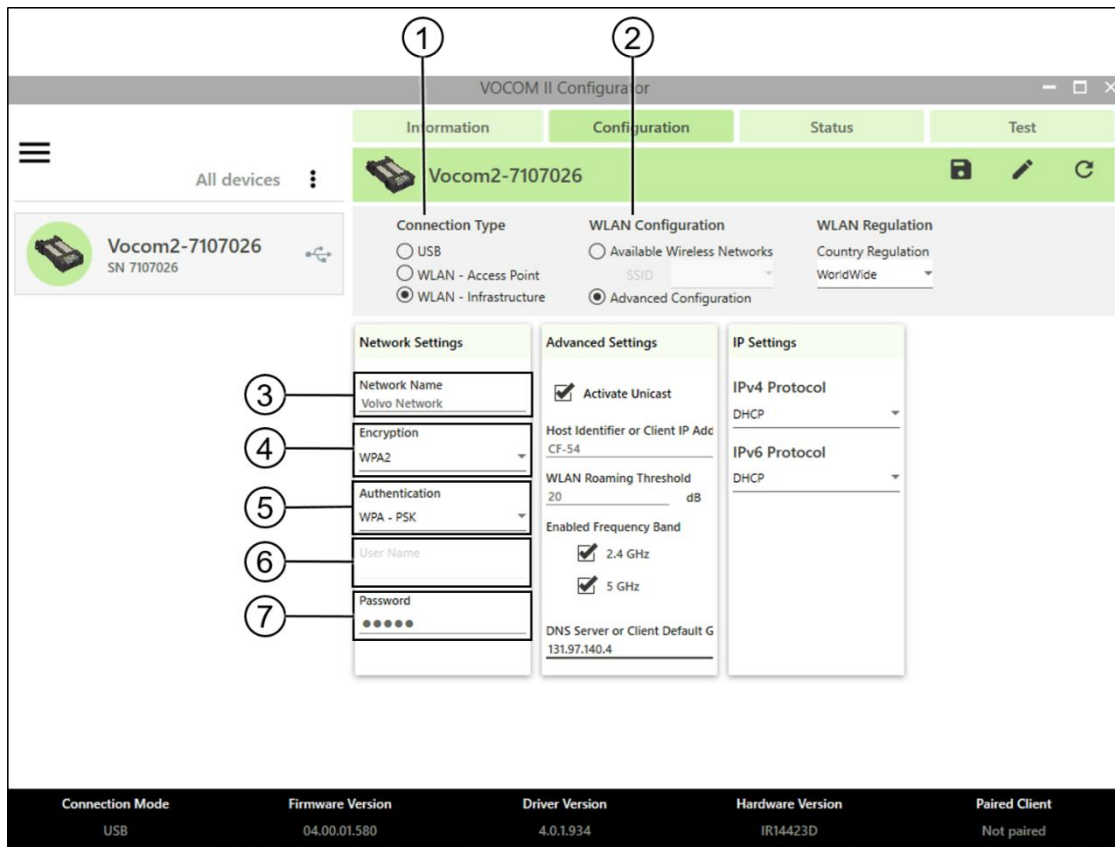

Fig. 7–13: WLAN-Infrastructure

- |   |                 |   |                          |
|---|-----------------|---|--------------------------|
| 1 | Connection Type | 2 | WLAN Configuration panel |
| 3 | Network name    | 4 | Encryption               |
| 5 | Authentication  | 6 | User Name                |
| 7 | Password        |   |                          |

The default setting is WPA+WPA2/WPA-PSK for password-based authentication and encryption, which is normally used for small “personal” wireless networks. This WLAN Infrastructure mode is commonly called “WPA-Personal”.

Other available/configurable authentication/encryption methods for WLAN Infrastructure mode are EAP-TLS and EAP-PEAP, providing certificate-based authentication through central servers, which is normally the case for larger company networks. These infrastructure modes are commonly called "WPA Enterprise".

### 7.3.2.1 Network Settings for WPA-PSK

For WPA-Personal mode, the following network parameter have to be set.

Parameter	Description
<b>Network name</b>	The name (SSID) of the network
<b>Encryption</b>	Should be set to WPA + WPA2
<b>Authentication</b>	Must be set to WPA-PSK
<b>Password</b>	The network password (pre-shared key)

Tab. 7-2: WPA-Personal mode parameters.

**Note:** The WPA-PSK password length must be  $\geq 8$  characters.

### 7.3.2.2 Network Settings for EAP-TLS/EAP-PEAP

For WPA-Enterprise mode the following network parameter have to be set.

Parameter	Description
<b>Network name</b>	The name (SSID) of the network
<b>Encryption</b>	Should be set to WPA + WPA2
<b>Authentication</b>	Must be set to either EAP-TLS or EAP-PEAP. If necessary, ask your network administrator which authentication type is supported by your network
<b>Certificate file</b>	Encrypted client certificate in PKCS12 format
<b>Certificate password</b>	Password for decrypting the client certificate, if certificate password is required
<b>User name</b>	User/identity for which the certificate has been issued

Tab. 7-3: WPA-Enterprise mode parameters.

**Note:** For EAP-TLS configuration, the **Password** field of the Network Settings page must be empty.

To upload and install the selected client certificate on the VOCOM II (which needs this certificate for later authentication on the network's Radius server), click **Install** button.

After successful upload and installation of a certificate on the VOCOM II, the currently installed client certificate will be listed in the Network Settings panel.

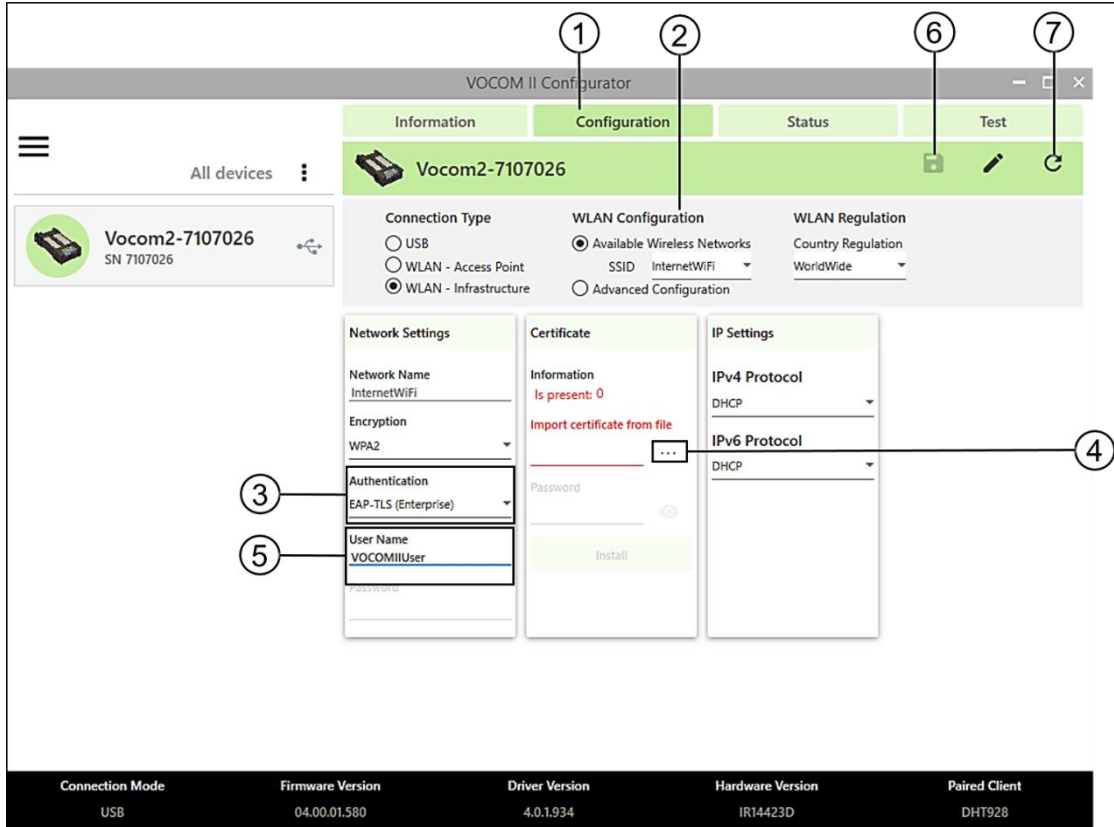

Fig. 7–14: WLAN - Infrastructure EAP-TLS configuration

- |   |   |
|---|---|
| <ul style="list-style-type: none"> <li>1 Configuration tab</li> <li>3 Authentication</li> <li>5 User Name</li> <li>7 Reboot button</li> </ul> | <ul style="list-style-type: none"> <li>2 WLAN Configuration panel</li> <li>4 Certificate/Install button</li> <li>6 Save button</li> </ul> |
|---|---|

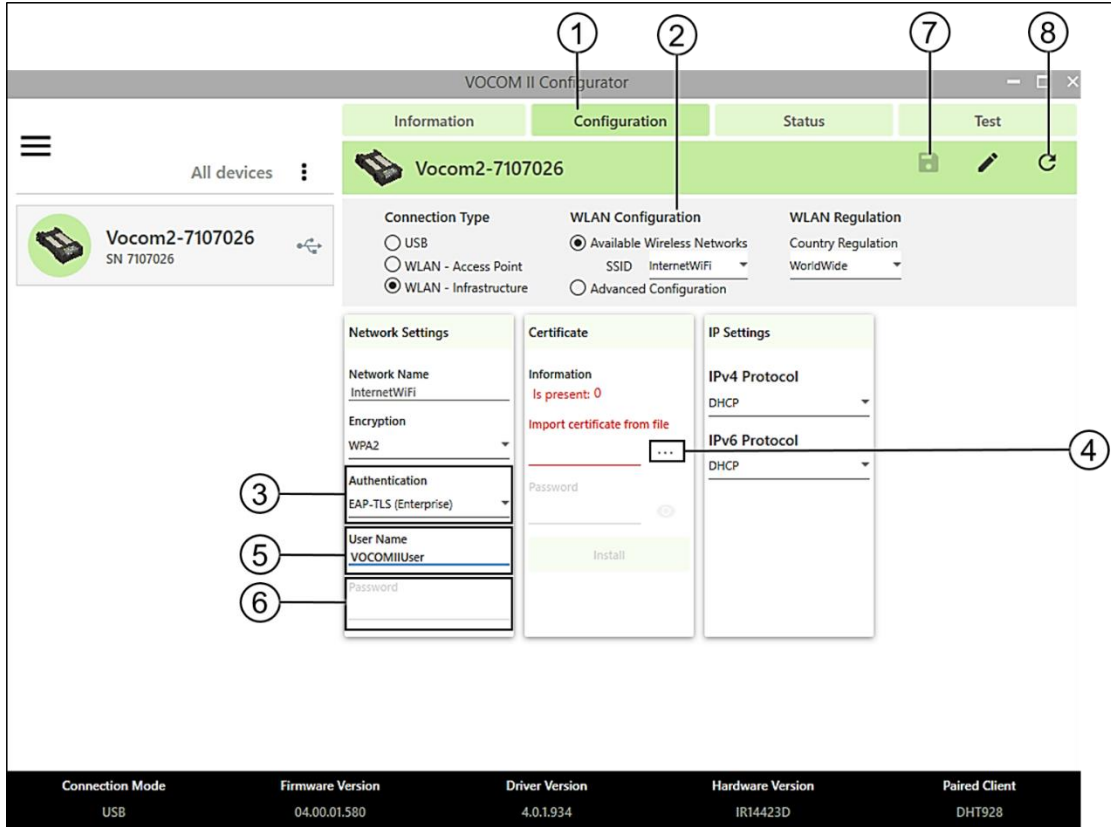

Fig. 7–15: WLAN - Infrastructure EAP-PEAP configuration

- |   |                   |   |                            |
|---|-------------------|---|----------------------------|
| 1 | Configuration tab | 2 | WLAN Configuration panel   |
| 3 | Authentication    | 4 | Certificate/Install button |
| 5 | User Name         | 6 | Password                   |
| 7 | Save button       | 8 | Reboot button              |

### 7.3.2.3 Country settings

The use of radio channels for 2.4-GHz and 5-GHz is regulated and differs among countries regarding the set of allowed radio channels and maximum transmission power.

**Note:** The VOCOM II factory default configuration uses a "golden set" of 2.4-GHz and 5-GHz radio channels that can be used worldwide.

The VOCOM II Configurator will automatically set the WLAN regulatory country code based on the locale settings of the client PC.

For the country-specific WLAN radio settings implemented in VOCOM II firmware see chapter 12.3 WLAN country settings.

These radio settings cannot be changed by the user.

### 7.3.2.4 Advanced Configuration setup

The VOCOM II Configurator allows Windows users with Administrator profile to manually adjust the standard **WLAN - Infrastructure** configurations.

The following **WLAN - Infrastructure** settings can be manually adjusted:

- IPv4 and IPv6 address assignment.
- WLAN roaming threshold.
- Frequency band selection.
- Setup of VOCOM II for Unicast operation.

To show the manual **WLAN - Infrastructure** settings, perform the following steps:

- 1 Open the **WLAN - Infrastructure** configuration page.
- 2 Select **Advanced configuration** in the **WLAN Configuration** panel.

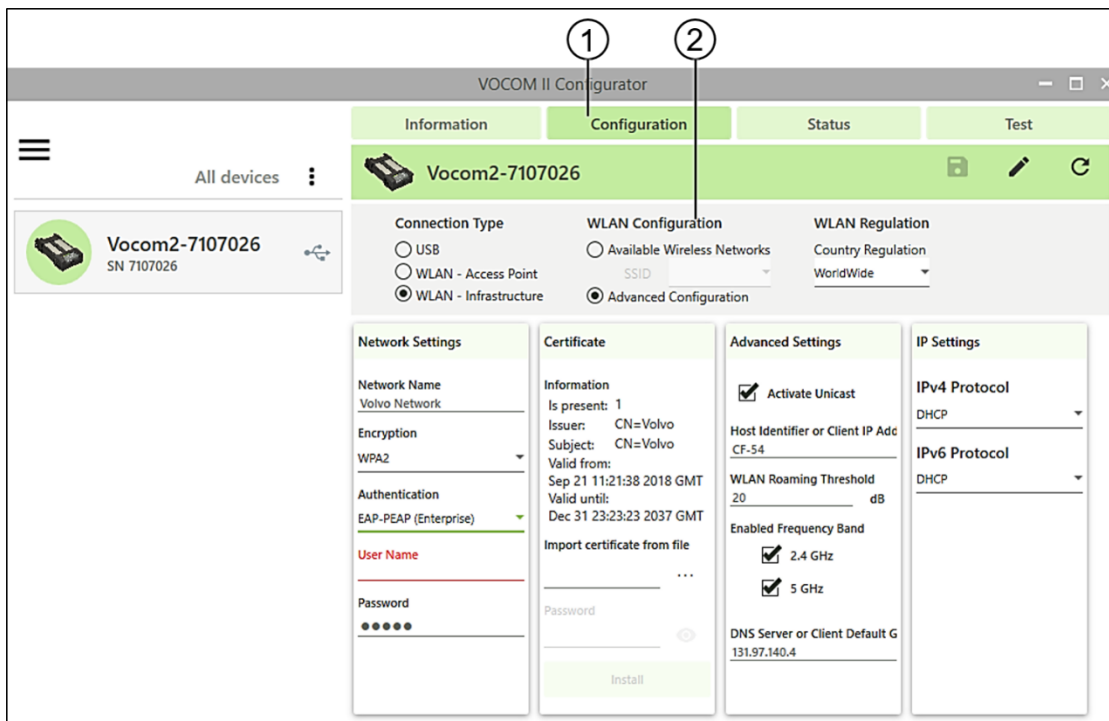

Fig. 7–16: WLAN - Infrastructure – Advanced Configuration

1 Configuration tab

2 WLAN Configuration panel

**7.3.2.5 IPv4 and IPv6 address assignment**

The VOCOM II WLAN interface configuration supports the following IPv4 and IPv6 address assignment methods.

Assignment method	Description
DHCP	Use a dynamically assigned IP address from the network's DHCP server.
Use IP address	Manually set a static IPv4 and/or IPv6 address.
APIPA	Obtain a unique, link-local IP address using a Zeroconf algorithm.

Tab. 7-4: IPv4 and IPv6 address assignment methods

To use a static IPv4 address assignment for the VOCOM II WLAN interface, perform the following steps:

- 1 Open the **WLAN - Infrastructure** configuration page.
- 2 Select **Advanced Configuration** in the **WLAN Configuration** panel.
- 3 Change the IPv4 and IPv6 address assignment according to your needs.
- 4 Click **Save**.
- 5 Click **Reboot**.

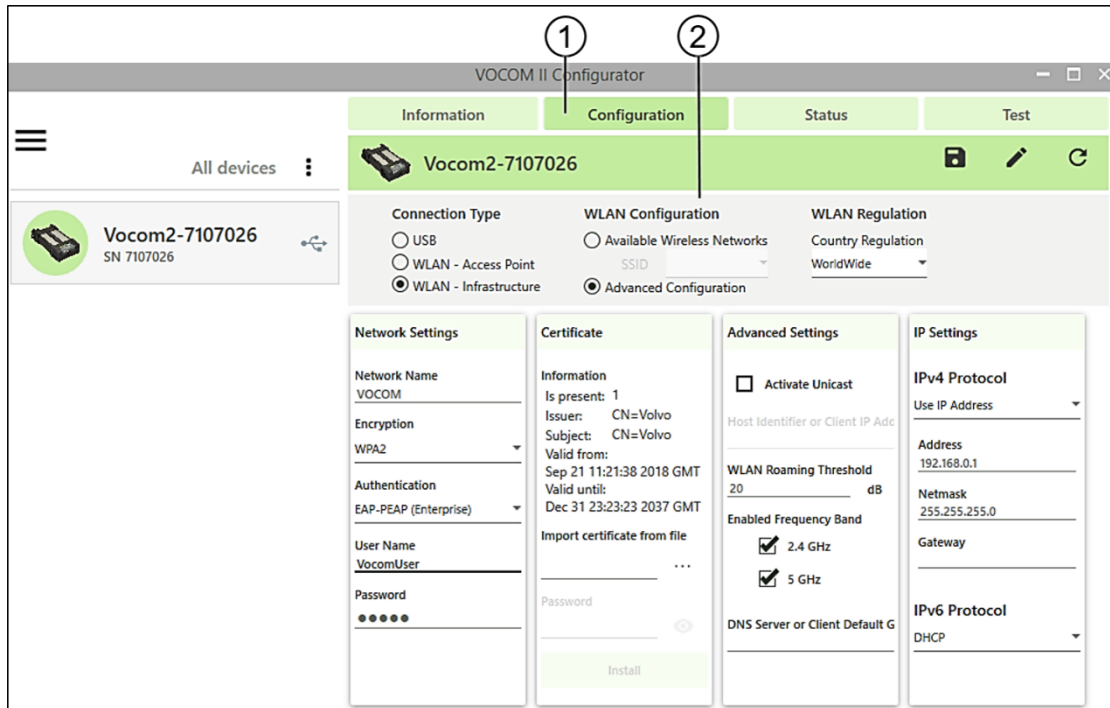

Fig. 7-17: WLAN - Infrastructure configuration – static IPv4 address assignment

**1** Configuration tab

**2** WLAN Configuration panel

**Note:** The **Gateway** field has to be either set to the IP address of the wireless network gateway or, if the client PC is located in the same network, left empty.

**Note:** Assigning a static IPv4 address is necessary if the Access Point of the wireless network does not support DHCP and there is no DHCP server behind the Access Point.

### 7.3.2.6 WLAN roaming threshold

The WLAN roaming threshold parameter defines the Signal-to-Noise ratio (SNR) in dB. This is used to set the background scanning interval for roaming.

If the SNR of the current Access Point is above the threshold (indicating a good signal), the background scanning frequency is decreased. If the SNR of the current Access Point is below the threshold (indicating a low signal), the background scanning frequency will be increased.

**Note:** If an Access Point with higher signal strength is found during background scanning, VOCOM II will try to roam to the new Access Point.

**Note:** Only change the WLAN roaming threshold if you have connectivity problems due to too frequent or too slow roaming. The default threshold value of 20 dB should work well for most WLAN infrastructures.

### 7.3.2.7 Frequency band selection

The frequency band selection check boxes from **WLAN – Infrastructure, Advanced Settings** allow users with Administrator profile to restrict WLAN channel scanning to either 2.4-GHz or 5-GHz channels.

By default VOCOM II performs scans for Access Points of a wireless network on both frequency bands.

**Note:** Restricting the WLAN frequency band to either 2.4-GHz or 5-GHz will reduce the number of WLAN channels to be considered in background scanning.

### 7.3.2.8 Unicast mode

Selecting check box **Activate Unicast** shows the following extra settings for wireless infrastructure. This configuration is used when IP multicasting is not supported in the network. **Unicast** mode enables the user to connect to a wireless network using unicasting.

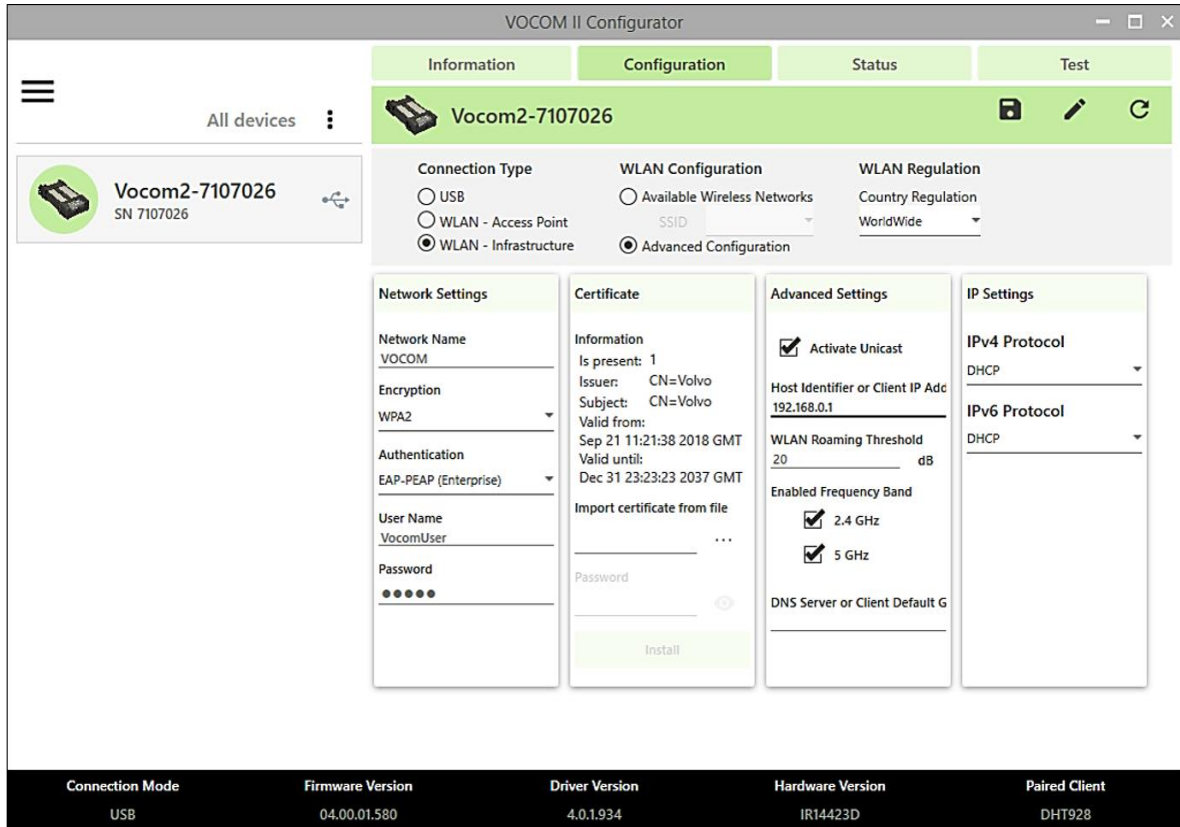

Fig. 7–18: Unicast setting where Host Identifier is an IP address



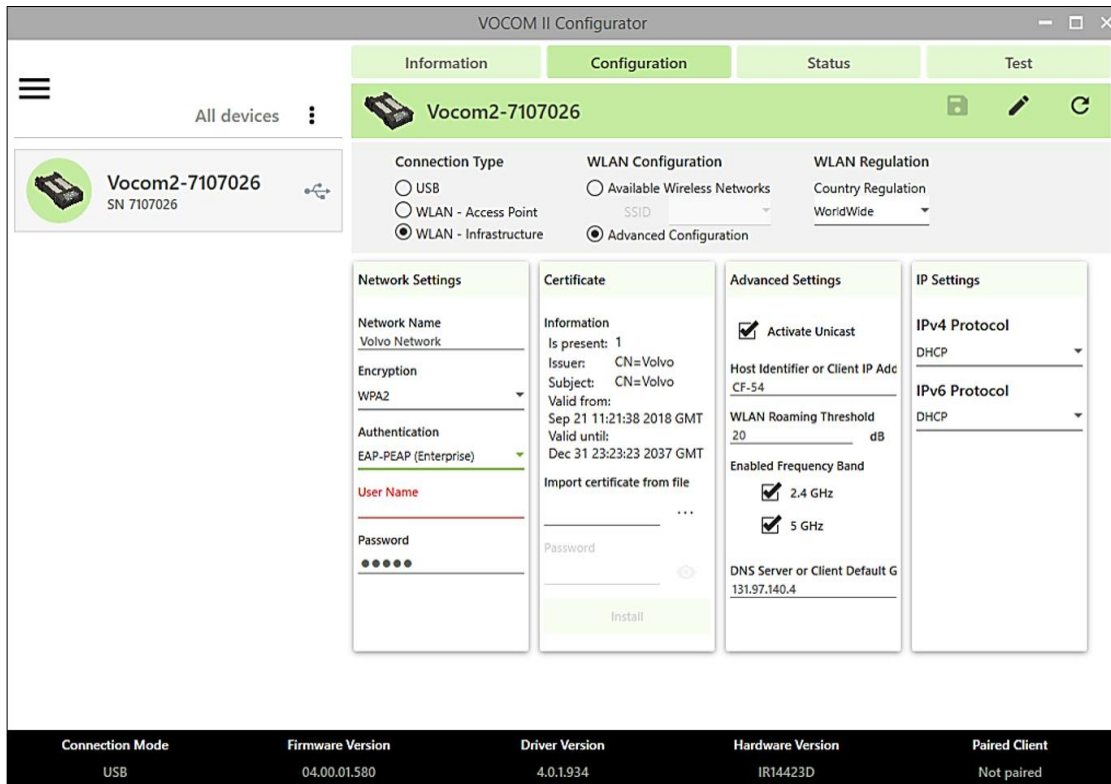

Fig. 7–19: Unicast mode where host Identifier is Computer name and need DNS Server IP

If the host identifier is a DNS name, the **Unicast** infrastructure configuration will also require the provision of the DNS server IP address.

**Note:** If the host identifier is a DNS name, it has to be a full qualified DNS name including the DNS suffix.

For more information about **Unicast** infrastructure setup contact help desk.

### 7.4 Options menu functions

The Options menu is located in the top-left corner of the Configurator window. It provides options for client-specific settings like display language, RP1210 and J2534 device mappings, log levels and help links.

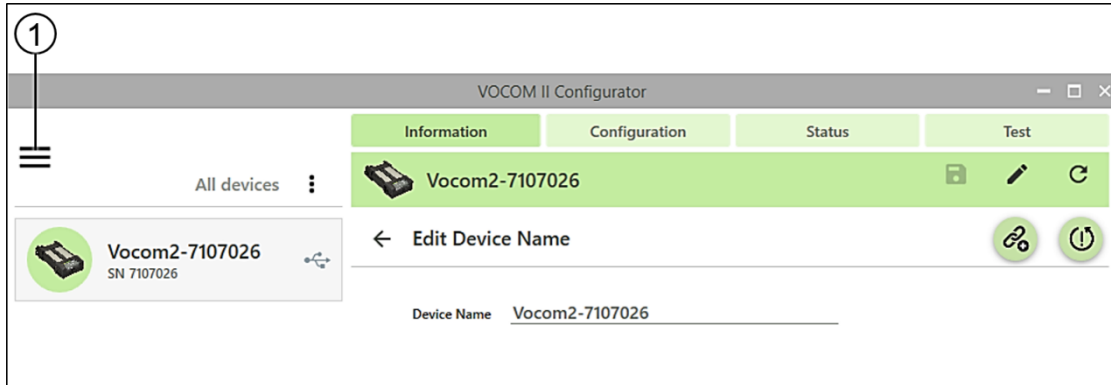

Fig. 7–20: Options menu location in VOCOM II Configurator

#### 1 Options menu button

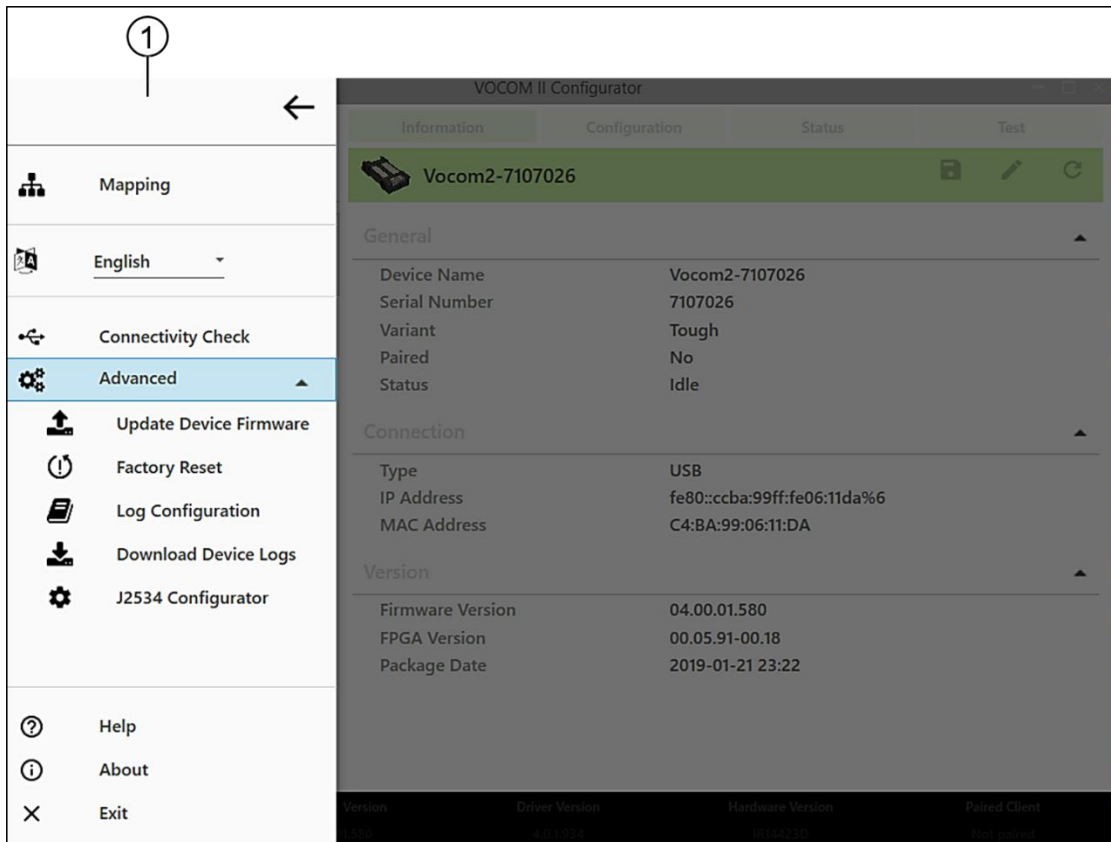

Fig. 7–21: Options menu

#### 1 Options menu

### 7.4.1 Language settings

The VOCOM II Configurator has built-in multilanguage support. English is the default display language.

To change the display language, perform the following steps:

- 1 Use the language drop-down menu under the Options menu to select another display language.
- 2 Restart the VOCOM II Configurator.

### 7.4.2 Connectivity Check

If there are issues when trying to connect to the VOCOM II, use the **Connectivity Check**. The test will tell what the issue might be.

### 7.4.3 Log Configuration

Log levels can be changed per log module.

The available VOCOM II log modules are as follows:

Logging module	Description	Scope
J2534	J2534 API logging	Windows logs and device traces
J2534-1	J2534-1 API logging	Windows logs and device traces
RP1210	RP1210C API logging	Windows logs and device traces
VocomConfiguration	VOCOM II Config API logging	Windows logs
VocomLocate	VOCOM II Locate API logging	Windows logs
VocomService	VOCOM II Service logging	Windows logs

Tab. 7-5: VOCOM II log modules

To change the log level of a particular module, perform the following steps:

- 1 Open the **Log Configuration** page by clicking **Log Configuration** in the Options menu.
- 2 Change the **Log level** of one or more log **Modules**.
- 3 Click **Save**.

**Note:** Log level changes will immediately take effect after step 3, no reboot is necessary.

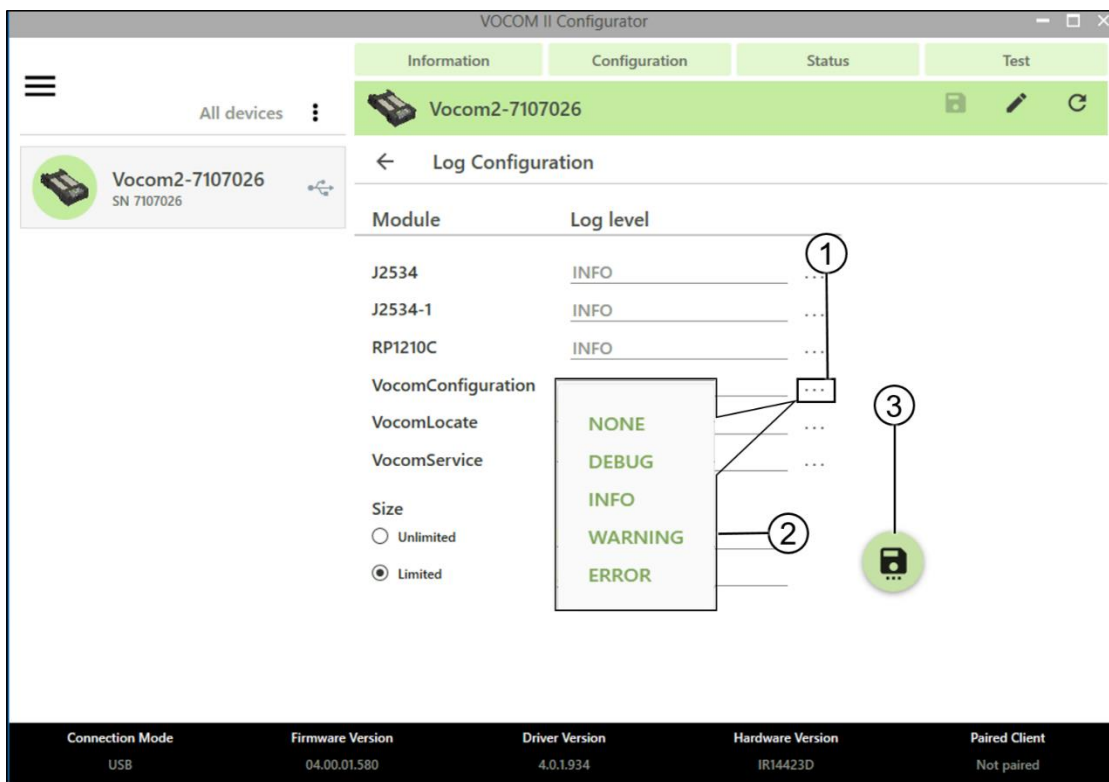

Fig. 7–22: Log Configuration page

- |                         |                   |
|-------------------------|-------------------|
| 1 Log level menu button | 2 Log levels menu |
| 3 Save button           |                   |

Changing the log level for components with scope "Windows logs and device traces" will affect both the log level on device side and on PC side. This is the case for the VOCOM II diagnostic APIs, i.e. RP1210C API and J2534/J2534-1 API.

Downloading device traces can be done through the VOCOM II Configurator. See section 7.4.7 Download log files.

VOCOM II Windows logs can be found under:  
C:\ProgramData\ACTIA I+ME GmbH\VOCOM II\Log.

**Note:** Log levels will be reset to their default values by an installer update.

### 7.4.4 RP1210 device mapping

To change the mapping of logical RP1210 Device IDs to VOCOM II devices, perform the following steps:

- 1 Go to the **Mapping** configuration page found under the Options menu.
- 2 Assign one or more Device IDs to VOCOM II serial numbers.
  - a. In the **Mode** column, select the connection mode to be used for a particular Device ID.
  - b. In the **Device** column, select the VOCOM II serial number to be assigned to a particular Device ID.
- 3 Click **Save**.

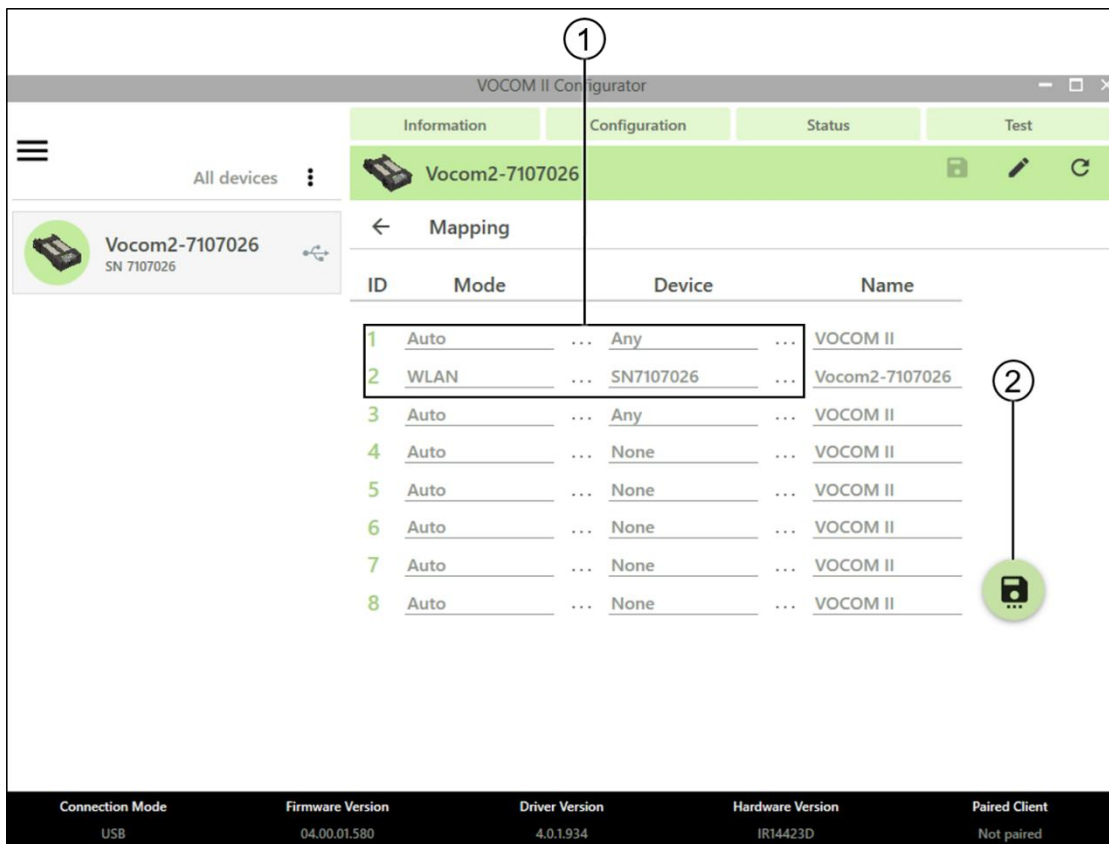

Fig. 7–23: Mapping configuration page (defaults)

1 Mapping columns

2 Save button

**Note:** The RP1210 Device ID mapping will be reset by an installer update.

The default RP1210 Device ID mapping is as follows:

Device ID	Mapping
RP1210 Device ID 1	Map to first USB-connected VOCOM II from Device list.
RP1210 Device ID 2	Map to first WLAN-connected VOCOM II from Device list.
RP1210 Device ID 3	Map automatically to Any.
RP1210 Device IDs 4–8	Not mapped by default.

Tab. 7–6: Default RP1210 Device ID mapping

If there is two WLAN-connected VOCOM II operated from a client PC, perform the following steps to change the RP1210 device mapping on that PC:

- 1 Go to the **Mapping** configuration page found under the Options menu.
- 2 Perform the Device ID assignment for each of the two WLAN-connected devices.
- 3 Click **Save**.

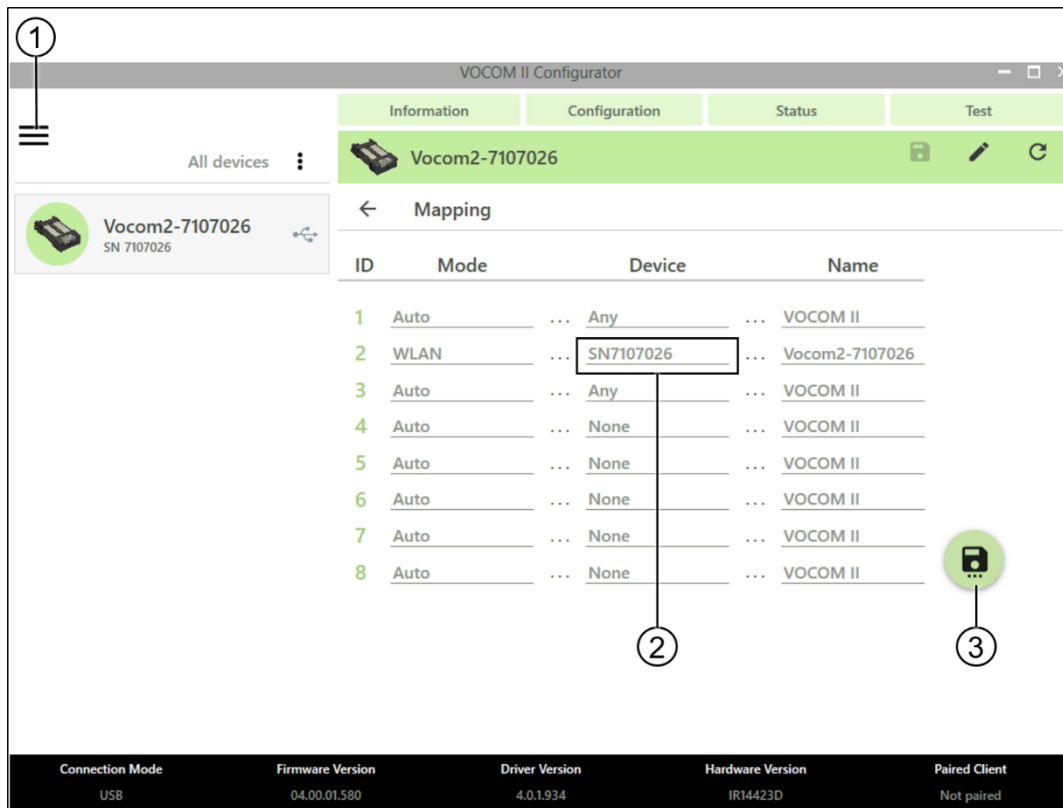

Fig. 7–24: RP1210 Device ID mapping example for two WLAN-connected VOCOM II devices

- 
- |   |   |
|---|---|
| <ol style="list-style-type: none"> <li>1 Options menu</li> <li>3 Save button</li> </ol> | <ol style="list-style-type: none"> <li>2 Mapping columns</li> </ol> |
|---|---|
-

### 7.4.5 PassThru Configurator

To select the active J2534/J2534-1 PassThru device, perform the following steps:

- 1 Go to the VOCOM II **PassThru Configurator** tool found under Advanced in the Options menu in the VOCOM II Configurator.
- 2 In the **PassThru Configurator** dialog, enter the serial number of the VOCOM II device that will be used as PassThru device on the client PC.
- 3 Click **OK**.



Fig. 7–25: VOCOM II J2534 PassThru Configurator

**1** Serial Number

**2** OK button

**Note:** The VOCOM II serial number is a 7-digit string of the form "7xxxxx", e.g. 7100200.

**Note:** The VOCOM II PassThru device settings are reset by an installer update.

### 7.4.6 Help and About menus

At the bottom of the Options menu, you will find the **Help** and **About** items.

Clicking the **Help** item will open and display the VOCOM II Tough Operation Instructions (this document).

Clicking the **About** item displays version information for VOCOM II Configurator.

### 7.4.7 Download log files

The Download page offers the possibility to get log files from VOCOM II. This information is typically needed for debugging purposes and support cases (i.e. the user help desk may request this data from you).

The following two sources of logging data are available:

Source	Description
Message Logs	Protocol traces from VOCOM II RP1210 and J2534 servers
Debug Logs	Complete device logs needed for support cases

Tab. 7-7: Logging data sources

**Note:** Log data will be provided as zip-archive for each source.

To download VOCOM II log files, perform the following steps:

- 1 Choose the source of log data you want to download.
- 2 Select the target folder for the download.
- 3 Change the name of the file to be stored (optional).
- 4 Click the Download button to download **Device Logs** to specified location.

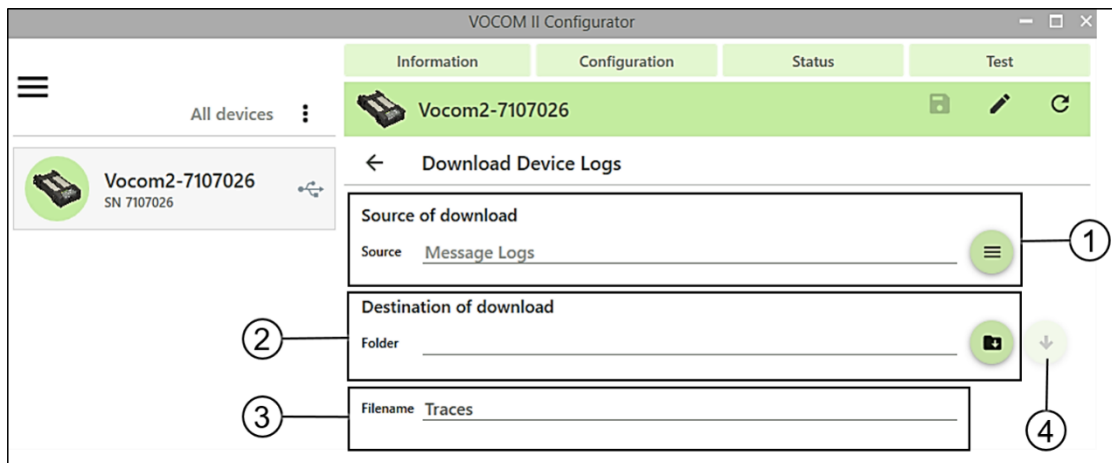

Fig. 7-26: Download traces from VOCOM II

- |                      |                           |
|----------------------|---------------------------|
| 1 Source of download | 2 Destination of download |
| 3 Filename           | 4 Download button         |



## 7.5 Status tab

VOCOM II logs critical events and errors in an internal **Device Error List**.

The contents of the internal **Device Error List** can be displayed, filtered and reset through the Status page of the VOCOM II Configurator.

- To load the **Device Error List** and display present events, click the Refresh button.
- To reset the **Device Error List**, click the Delete button.

**Note:** Clearing the **Device Error List** will also reset the state of the warning LEDs.

- To display only specific error types, click on the Filter button.

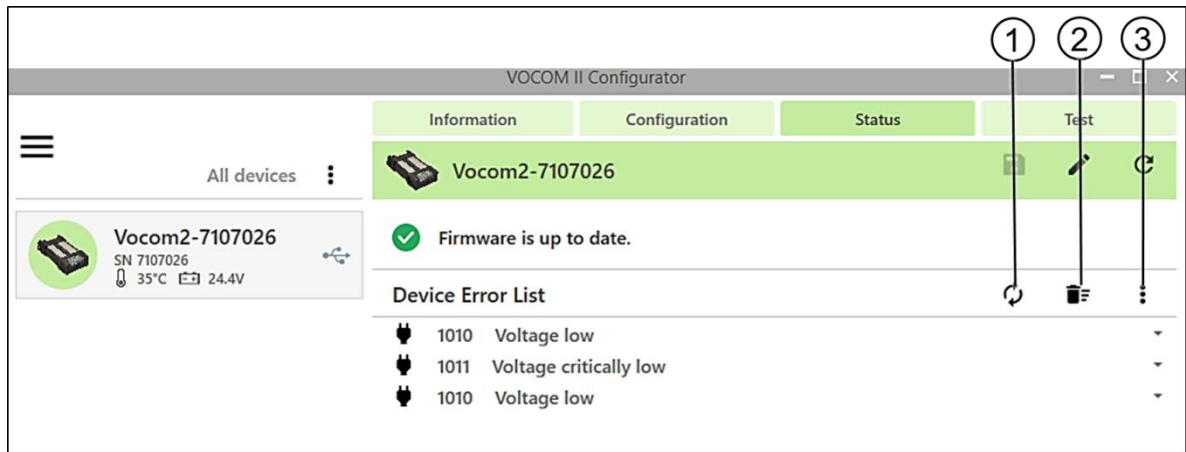

Fig. 7–27: Status page

- 
- 1 Refresh button  
3 Filter button

- 2 Delete button
- 

To display the extended description of an event, click on one of the down-arrows of a **Device Error List** entry.

## 7.6 Test tab

The communication test can be found in the Test tab.

Use this for a fast overview of what communication lines are opened to a connected vehicle.

## 8 Operation

### 8.1 WLAN mode operation

#### 8.1.1 Prerequisites

Make sure the VOCOM II Windows software has been installed on the client PC.

Configure the WLAN interface for operation in one of the WLAN modes. See section 7.3 WLAN configuration.

To use the WLAN interface, perform the following steps:

- 1 Unplug the device from the USB port of the PC.
- 2 Connect the ECTA/OBD cable to the vehicle/platform.
- 3 Power the device from vehicle side.

#### 8.1.2 WLAN - Access Point mode

**Note:** **WLAN - Access Point** is the default WLAN operation mode of VOCOM II. In this mode, VOCOM II operates as an Access Point to which you can directly connect from your PC.

To connect to VOCOM II from your PC via **WLAN - Access Point**, perform the following steps:

**Note:** For details regarding default settings for network names and passwords see section 7.3.2 WLAN Infrastructure Mode.

- 1 Disconnect VOCOM II from USB port and power on from vehicle side.
- 2 Open the **Wireless Networks** dialog on your PC.
- 3 Find the network name corresponding to your VOCOM II device.
- 4 Connect to the network and enter the password.

If connected, the WLAN signal strength indicators of VOCOM II will be ON.

For more information on function indicators for WLAN operation, see section 4.2.1 WLAN operation mode.

#### 8.1.3 WLAN device access in RP1210 API

The RP1210 Device ID mapping can be controlled through the VOCOM II Configurator. See section 7.4.4 RP1210 device mapping.

The default RP1210 Device ID for WLAN connected devices is Device ID 2. By using Device ID 2 in RP1210\_ClientConnect, you connect to the first VOCOM II WLAN device found in the Device list.

For workshops and applications with several wireless VOCOM II units, you have to manually set up the RP1210 device mapping in the VOCOM II Configurator.

## 8.2 USB mode operation

### 8.2.1 Prerequisite

Make sure that the VOCOM II Windows software has been installed on the PC. See section 5.1 Installation.

### 8.2.2 USB mode

To connect the VOCOM II device to the USB port of the PC, use the 12-pin ECTA/USB-OBD cable.

To connect the VOCOM II device to the vehicle / platform, use the 26-pin ECTA/OBD cable.

When connected via USB, the VOCOM II device is represented in the Windows Device Manager as network adapter named "VOCOM II Tough".

For more information on function indicators for USB operation, see section 4.2.2. USB operation mode.

## 9 Troubleshooting

### 9.1 Firewall rules

For proper operation of the VOCOM II hardware, the following firewall rules have to be set up. For the standard Windows firewall, the VOCOM II Windows installer will add these firewall rules automatically during the installation process.

Firewall rule	Setting
VOCOM II CAST	<ul style="list-style-type: none"> <li>● Direction: Inbound</li> <li>● Protocol: UDP</li> <li>● Port: 427</li> </ul>
VOCOM II HTTP	<ul style="list-style-type: none"> <li>● Direction: Outbound</li> <li>● Protocol: TCP</li> <li>● Port: 80</li> </ul>
VOCOM II HTTP	<ul style="list-style-type: none"> <li>● Direction: Outbound</li> <li>● Protocol: TCP</li> <li>● Port: 27015</li> </ul>
VOCOM II HTTP	<ul style="list-style-type: none"> <li>● Direction: Outbound</li> <li>● Protocol: TCP</li> <li>● Port: 2534</li> </ul>

Tab.9-1: Firewall rules

### 9.2 General procedure

To carry out troubleshooting, perform the following steps:

- 1 Make sure that the product is keyed on.
- 2 Check the instrument cluster and make sure that the battery voltage is correct.
- 3 Make sure that the vehicle cable is not damaged and none of the PINs are bent.
- 4 Make sure that the LED status is as described in section 4.2.2 USB operation mode.
- 5 Narrow down the problem.
  - Try with a different working vehicle cable.
  - Try with a different working USB cable and USB slot on the PC.
  - Try with another working communication unit (VOCOM II).
  - Try with another working PC.
- 6 If using WLAN, check that the WLAN is working properly. Consult your local IT support for advanced checking of WLAN.

**Note:** If none of the above solves the problem, contact support with the logs for support cases. See section 7.4.7 Download log files.

### 9.3 VOCOM II error codes

VOCOM II logs critical events and errors in an internal **Device Error List**. See section 7.5 Status tab.

The following overview will help you to determine possible faults and their causes and to carry out troubleshooting procedures.

The function indicators help you to detect possible faults.

If you cannot rectify a fault, please contact an authorized specialist or Support.

Error codes stay in the **Device Error List** until cleared.

Error code	Fault	Cause	Solution
0001	Wrong PSK	WLAN password doesnotmatch the password on the Access Point.	Reenter password and make sure that it matches the password on Access Point.
0003	Login credentials error	User name and/or password for authentication were rejected by authentication server.	Make sure user name/identity and/or password match those on the authentication server.
0004	Certificate invalid	Client certificate was rejected.	Upload a valid client certificate to the device.
0005	Certificate expired	Client certificate has expired.	Upload a valid client certificate to the device.
0006	Certificate not yet valid	Client certificate is not yet valid.	Upload a valid client certificate to the device.
0007	Wrong server certificate	Certificate sent by authentication server could not be validated with installed root certificate.	Make sure that the root certificate on the device is the same used by the network you wish to connect to.
0008	IEEE 802.1X authentication failed	Login credentials were rejected by authentication server.	Make sure to use a valid certificate or user name and password.

Error code	Fault	Cause	Solution
0100	Client connect with wrong PSK	A client tried to connect with an invalid password.	Make sure that the password is correct. Check for unauthorised WLAN users.
1001	Temperature high	Temperature is very high, warning state entered.	Switch on AC or find another means of cooling the device; alternatively, stop using it until ambient temperature is low enough.
1002	Temperature critical	Temperature has reached or exceeded critical value, system will be powered down.	Device has powered down; wait until ambient temperature is low enough.
1010	Voltage low	The voltage is lower than it should be.	Check the vehicle battery.
1011	Voltage critically low	The voltage is critically low, proper operation can no longer be guaranteed.	Check the vehicle battery.
1012	Voltage high	The voltage is higher than it should be.	Check the vehicle battery or charger.
1013	Voltage critically high	The voltage is critically high, proper operation can no longer be guaranteed.	Check the vehicle battery or charger.
1100	Update failed due to failed checksum check	The image contents as written to the flash memory were found to be corrupted.	Try the update again later.

Error code	Fault	Cause	Solution
1101	Update failed, image did not boot	The image failed to boot properly, for instance due to power loss during update.	Try the update again later.
1102	Update failed, image had invalid format	The file used for update was not a valid VOCOM II update image file.	Use only official, authorized update images.
1104	Update failed, image signature check did not pass	The image file was modified or corrupted.	Use only official, authorized update images.
2001	Missing DHCP address	DHCP client mode configured but no DHCP address received after n tries.	Check network settings - is a DHCP server available?
9000	Hardware fault: Flash #1	Firmware flash defect detected.	The device must be replaced
9001	Hardware fault: Flash #2	Application flash defect detected.	The device must be replaced
9002	Hardware fault: RAM	RAM defect detected.	The device must be replaced
9003	Hardware fault: WLAN calibration data	WLAN calibration data defect detected.	The device must be replaced
9004	Hardware fault: temperature sensor	Temperature sensor cannot be accessed.	The device must be replaced

Error code	Fault	Cause	Solution
9100	CAN communication error	Error in CAN communication.	<p>Make sure that the Self Test adapter is plugged.</p> <p>Repeat test with same Self Test adapter and another unit.</p> <p>If the other unit tests successfully, get a replacement for the erroneous one.</p>
9101	K-Line communication error	Error in K-Line communication.	<p>Make sure that the Self Test adapter is plugged.</p> <p>Repeat test with same Self Test adapter and another unit.</p> <p>If other unit tests successfully, get a replacement for erroneous one.</p>
9102	DoIP communication error	Error in DoIP communication.	<p>Make sure that the Self Test adapter is plugged.</p> <p>Repeat test with same Self Test adapter and another unit.</p> <p>If other unit tests successfully, get a replacement for erroneous one.</p>
9103	J1708 communication error	Error in J1708 communication.	<p>Make sure that the Self Test adapter is plugged.</p> <p>Repeat test with same Self Test adapter and another unit.</p> <p>If other unit tests successfully, get a replacement for erroneous one.</p>
9200	WLAN Self Test unsuccessful	Connection to the network unsuccessful after time-out.	<p>Make sure that network settings and credential match the network you wish to connect to.</p>



Error code	Fault	Cause	Solution
8000	USB unplugged while diagnostics session active	USB unplugged while diagnostics session active.	Plug device.
8001	Communication with vehicle communication CPU disturbed	Vehicle communication CPU is unreachable, connection disturbed.	Unplug device completely, then plug it in and try again. Update to latest firmware.
8010	RP1210App crashed (certain LED status)	Abnormal end due to crash	Repower device and try again. Update to latest firmware.
8011	PTApp crashed (certain LED status)	Abnormal end due to crash	Repower device and try again. Update to latest firmware.

Tab. 9-2: Troubleshooting machine faults of VOCOM II

## 10 Maintenance

Maintenance work serves to maintain the operational readiness and prevent premature wear. Maintenance is divided into:

- Care and cleaning
- Checks and updates
- Repairs

### 10.1 Care and cleaning

When cleaning the exterior of the device, proceed as follows:

- Remove dirt.
- Remove loose dirt and dust using a moist cloth.

### 10.2 Checks and updates

Checks and updates are divided into:

- Regular checks
- Firmware updates

**Note:** The device is maintenance-free except for regular firmware updates.

#### 10.2.1 Regular checks

To ensure that the device is in proper operating condition, you must check that the device functions properly.

- Report any defects found.
- Immediately report any defects found to the responsible supervisor. At shift change, the off-going member of staff must pass on any defects found and measures already taken.
- If there are defects that affect the operational safety, take the device out of service.

### 10.3 Repairs

Repair works include the replacement of the complete VOCOM II device and are only required when components are damaged by wear or other external circumstances.

- Do not repair the VOCOM II device yourself.

## 10.4 Disposal

After the end of its useful life, VOCOM II must be properly taken out of service and disposed of.

The device contains electrical components that must be disposed of separately.

- Ensure that the disposal is done properly and in an environmentally sound way.
- Do not dispose VOCOM II with household waste.
- Bring the device to a specialist company for proper disposal.
- Observe the national and local regulations during disposal.
- Observe WEEE Directive 2012/19/EU.

## 11 Technical specifications

Parameter	Description
Dimensions (W x H x D)	160 mm x 91 mm x 44 mm
Weight	Approx. 400 g
Temperature range	-40°C to +85°C / -40°F to +185°F
EMC	CE and E1-marking
Voltage ratings	Electrical Letter code A and E 6 V to 32 V operating voltage
<b>Vehicle/Platform</b>	
Power supply	12 V/24 V operation, Vehicle power: 6–32 V, max. 36
Vehicle connector	26-pin ECTA connector
Host connector	12-pin ECTA connector
<b>Vehicle interfaces</b>	
CAN	1 x CAN2.0B with up to 1 Mbit/s 1 x CAN FD with up to 8 Mbit/s
J1708	1 x J1708 J1708 bus topology, 20 nodes @9600 bit/s J1708 high speed 1 to 1 @14400, 19200, 38400, 57600, 115200 bit/s
K-Line	1 x K-Line 1 x K-Line 5 V (non OBD)
DoIP/Ethernet	100Base-TX, supports DoIP Type A and Type B
Digital I/O	3 x Digital In (non OBD) 3 x Digital Out (non OBD)
Protocol support	ISO 11898, ISO 15765-2, SAE J1939, SAE J1708, ISO 9141, KWP 2000, ISO 13400-2
Legacy protocols	Knorr/Wabco ABS, NIRA EDC1, Volvo Penta MEFI, BOSCH EDC, J1708 DIS, Geartronic, SL2, Q/A, Free Running
Smartcable	SL2, Q/A, Free Running
USB/Ethernet interface	USB 2.0 with 480 Mbit/s USB/Ethernet communication via RNDIS interface

Parameter	Description
WLAN interface	IEEE 802.11 a/b/g/n Dual band support 2.4/5-GHz MIMO support, 2 WLAN antennas (WiFi-Direct support)
Diagnostic APIs	RP1210C, J2534, J2534-1, VOCOM II Smartphone API
<b>Processing</b>	
Connectivity CPU	Qualcomm/Atheros AR9350 SoC
Vehicle CPU	SmartFusion2 SoC
Memory	2 x 128-MB DDR RAM, 128 MB NAND FLASH, 16 MB NOR FLASH

Tab. 11–1: Technical specifications of VOCOM II

## 12 Appendix

### 12.1 Specifications

Tab. 12–1 lists the product features of VOCOM II Tough.

Parameter	Description
Vehicle Power supply	Supports 12 V or 24-V power supply Operating voltage 6–32 V
USB Power Supply	USB 2.0 High-Power Device or USB 3.0 High-Power Device
CPU	QUALCOMM/Atheros AR9350, 32-bit MIPS 74 Kc, 533 MHz
RAM	2x128 MB DDR
Storage	128 MB NAND FLASH 16 MB NOR FLASH
USB	USB 2.0 High-Power Device
Network Interface	USB Ethernet communication via RNDIS interface
WiFi Standards and Frequency Bands	IEEE 802.11 a/b/g/n Hardware supports 2.4 GHz and 5 GHz operation
WiFi Security	WPA (TKIP/PSK), WPA2(PSK/Enterprise), WPS
WiFi Configuration	Infrastructure (Access Point/Client) and WiFi-Direct
Vehicle Connector	ECTA/OBD
Vehicle interface	CAN, J1708, K-Line, DoIP/Ethernet, Digital I/O
Diagnostic APIs	RP1210C, J2534, J2534-1, VOCOM II Smartphone API
Operating system support	Windows 7, 8, 10 (32/64 bit)

Tab. 12–1: Product features of VOCOM II

## 12.2 Vehicle communication interfaces

Tab. 12–2 lists the available vehicle communication interfaces for VOCOM II:

Vehicle communication	Description
CAN	2 CAN channels <ul style="list-style-type: none"> <li>Compliant to ISO 11898-2:2015</li> </ul>
J1708	1x SAE J1708 channel <ul style="list-style-type: none"> <li>J1708 bus topology, 20 nodes @9600 bit/s J1708 high-speed 1 to 1 @14400, 19200, 38400, 57600, 115200 bit/s</li> </ul>
ISO 9141	1x K-Line, 1x L-Line <ul style="list-style-type: none"> <li>Baud rates: 600–115200 baud</li> </ul>
ISO 13400	1x DoIP Ethernet <ul style="list-style-type: none"> <li>Supports both vehicle pinning variants</li> </ul>
Digital I/O	3x DI <ul style="list-style-type: none"> <li>Low: 0–3.5 V, High: 7.2–32 V, TH: 4.25 V 3x DO</li> <li>High-side automotive switches, 200 mA</li> </ul>
RT legacy	Via VOCOM II Smartcable

Tab. 12–2: Vehicle communication interfaces of VOCOM II

### 12.3 WLAN country settings

CC	Country	Req	Sup	Cert	1-11 2402-2472	12-13 2457-2482	36-48 5170-5250	P5	52-64 5250-5330	P5	100-140 5490-5710	P5	144 5710-5730	P5	149-165 5735-5835	P5	Comment
00	Default				20	0	0		0	x	0		0		0		The factory WLAN setting is 2.4 GHz AP mode with CH 1-11 and 20dbm.
AE	United Arab Emirates	x	x		20	20	17		20	x	20	x	20	x	14	x	
AR	Argentina	x	x		20	20	17		20	x	20	x	20	x	14	x	
AT	Austria	x	x	R&TTE	20	20	17		20	x	20	x	0	0	0	0	
AU	Australia	x	x		20	20	17		20	x	20	x	0	0	14	x	
BE	Belgium	x	x	R&TTE	20	20	17		20	x	20	x	0	0	0	0	
BG	Bulgaria	x	x	R&TTE	20	20	17		20	x	20	x	0	0	14		Channel 147 allowed as well
BR	Brazil	x	x		20	20	17		20	x	20	x	20	x	14	x	
BY	Belarus	x	x		20	20	17		20	x	20	x	0	0	0	0	
CA	Canada	x	x	FCC	20	0	17		20	x	20	x	20	x	14		Channels 120/124/128 NOT allowed
CH	Switzerland	x	x	R&TTE	20	20	17		20	x	20	x	0	0	0	0	
CL	Chile	x	x		20	20	17		20	x	0	0	0	14	x		
CN	China	x	x		20	20	17		20	x	0	0	0	14	x		
CO	Colombia	x	x		20	20	17		20	x	20	x	20	x	14	x	
CZ	Czechia	x	x	R&TTE	20	20	17		20	x	20	x	0	0	0	0	
DE	Germany	x	x	R&TTE	20	20	17		20	x	20	x	0	0	14		
DK	Denmark	x	x	R&TTE	20	20	17		20	x	20	x	0	0	0	0	
DZ	Algeria	x	x		20	20	17		20	x	20	x	0	0	0	0	Only 100-132, 136/140 not allowed
EC	Ecuador	x	x		20	20	17		20	x	20	x	20	x	14	x	
EE	Estonia	x	x	R&TTE	20	20	17		20	x	20	x	0	0	0	0	
ES	Spain	x	x	R&TTE	20	20	17		20	x	20	x	0	0	0	0	
FI	Finland	x	x	R&TTE	20	20	17		20	x	20	x	0	0	0	0	
FR	France	x	x	R&TTE	20	20	17		20	x	20	x	0	0	0	0	
GB	United Kingdom of Great Britain and Northern Ireland	x	x	R&TTE	20	20	17		20	x	20	x	0	0	0	0	
GR	Greece	x	x	R&TTE	20	20	17		20	x	20	x	0	0	0	0	
HK	Hong Kong	x	x		20	20	17		20	x	20	x	0	0	14	x	
HR	Croatia	x	x	R&TTE	20	20	17		20	x	20	x	0	0	0	0	
HU	Hungary	x	x	R&TTE	20	20	17		20	x	20	x	0	0	0	0	
ID	Indonesia	x	x		20	20							0	0	14	x	NOT channel 165
IE	Ireland	x	x	R&TTE	20	20	17		20	x	20	x	0	0	0	0	
IL	Israel	x	x		20	20	17		20	x	0	0	0	0	0	0	
IN	India	x	x		20	20	17		20	x	0	0	0	14	x		
IS	Iceland	x	x	R&TTE	20	20	17		20	x	20	x	0	0	0	0	
IT	Italy	x	x	R&TTE	20	20	17		20	x	20	x	0	0	0	0	
JP	Japan	x	x		20	20	17		20	x	20	x	0	0	0	0	
KR	Korea, Republic of	x	x		20	20	17		20	x	20	x	0	0	14	x	
KZ	Kazakhstan	x	x		20	20	0		0	0	0	0	0	0	0	0	
LT	Lithuania	x	x	R&TTE	20	20	17		20	x	20	x	0	0	0	0	
LV	Latvia	x	x	R&TTE	20	20	17		20	x	20	x	0	0	0	0	
MX	Mexico	x	x		20	20	17		20	x	20	x	20	x	14	x	
MY	Malaysia	x	x		20	20	17		20	x	20	x	0	0	14	x	100-128
NL	Netherlands, NL Antilles	x	x	R&TTE	20	20	17		20	x	20	x	0	0	14	x	
NO	Norway	x	x	R&TTE	20	20	17		20	x	20	x	20	x	14	x	Not 159, 161
NZ	New Zealand	x	x		20	20	17		20	x	20	x	20	x	14	x	
OM	Oman	x	x		20	20	17		20	x	20	x	0	0	0	0	
PE	Peru	x	x		20	20	17		20	x	20	x	20	x	14	x	
PL	Poland	x	x	R&TTE	20	20	17		20	x	20	x	0	0	0	0	
PR	Puerto Rico	x	x	FCC	20	0	17		20	x	20	x	20	x	14		
PT	Portugal	x	x	R&TTE	20	20	17		20	x	20	x	0	0	0	0	
QA	Qatar	x	x		20	20	0		0	0	0	0	0	14	x		
RO	Romania	x	x	R&TTE	20	20	17		20	x	20	x	0	0	0	0	
RU	Russian Federation	x	x		20	20	17		20	x	20	x	0	0	14	x	136-144
SA	Saudi Arabia	x	x		20	20	17		20	x	20	x	0	0	0	0	
SE	Sweden	x	x	R&TTE	20	20	17		20	x	20	x	0	0	0	0	
SG	Singapore	x	x		20	20	17		20	x	20	x	20	x	14	x	
SI	Slovenia	x	x	R&TTE	20	20	17		20	x	20	x	0	0	0	0	
SK	Slovakia	x	x	R&TTE	20	20	17		20	x	20	x	0	0	0	0	
TH	Thailand	x	x		20	20	17		20	x	20	x	20	x	14	x	
TR	Turkey	x	x	R&TTE	20	20	17		20	x	20	x	0	0	0	0	
US	United States of America	x	x	FCC	20	0	17		20	x	20	x	20	x	14		
ZA	South Africa	x	x		20	20	17		20	x	20	x	0	0	0	0	
ZZZ	Subset of all FCC/R&TTE countries, applicable upper limits for ALL countries				20	20	17		20	x	20	x	20	x	14	x	All channels above 48 are passive-scan so that no initiated radiation happens on channels that may not be allowed TxPower on U-NII-3 (149-165) is limited to 14 dBm because that is the maximum in some countries. This is only 25mW so it's doubtful if that is even usable. Channels 12-13 are not set to passive scan as they are of lesser concern to FCC, so if there happens to be scan packets on these frequencies because of a misconfiguration, it's not a show stopper