

STAMFORD®

MX321™ Automatic Voltage Regulator (AVR)
**SPECIFICATION, CONTROLS AND
ACCESSORIES**

Table of Contents

1. DESCRIPTION.....	1
2. SPECIFICATION.....	3
3. CONTROLS.....	5
4. ACCESSORIES.....	15

-

This page is intentionally blank.

1 Description

1.1 Separately-Excited AVR Controlled Alternators

A separately-excited AVR receives power from a separate permanent magnet generator (PMG), mounted on the main alternator shaft. The AVR controls the alternator output voltage by automatic adjustment of the exciter stator field strength. The AVR excitation remains at full capability when sudden loads are applied to the alternator, giving superior motor starting, short circuit and EMC performance.

1.1.1 Permanent Magnet Generator (PMG) excited - AVR controlled alternators

⚠ WARNING	
Strong Magnetic Field	
<i>The strong magnetic field from a permanent magnet generator (PMG) or excitation boost system (EBS), can cause serious injury or death by interference with implanted medical devices.</i>	
<i>To prevent injury, do not work near a PMG or EBS if you have an implanted medical device.</i>	

The AVR provides closed loop control by sensing the alternator output voltage at the main stator windings and adjusting the exciter stator field strength. Voltage induced in the exciter rotor, rectified by the rotating diodes, magnetises the rotating main field which induces voltage in the main stator windings. A separately-excited AVR is independently powered from a separate permanent magnet generator (PMG), mounted on the main alternator rotor shaft. Voltage is induced in the stator of the PMG by a rotor of permanent magnets.

TABLE 1. PMG EXCITED AVR

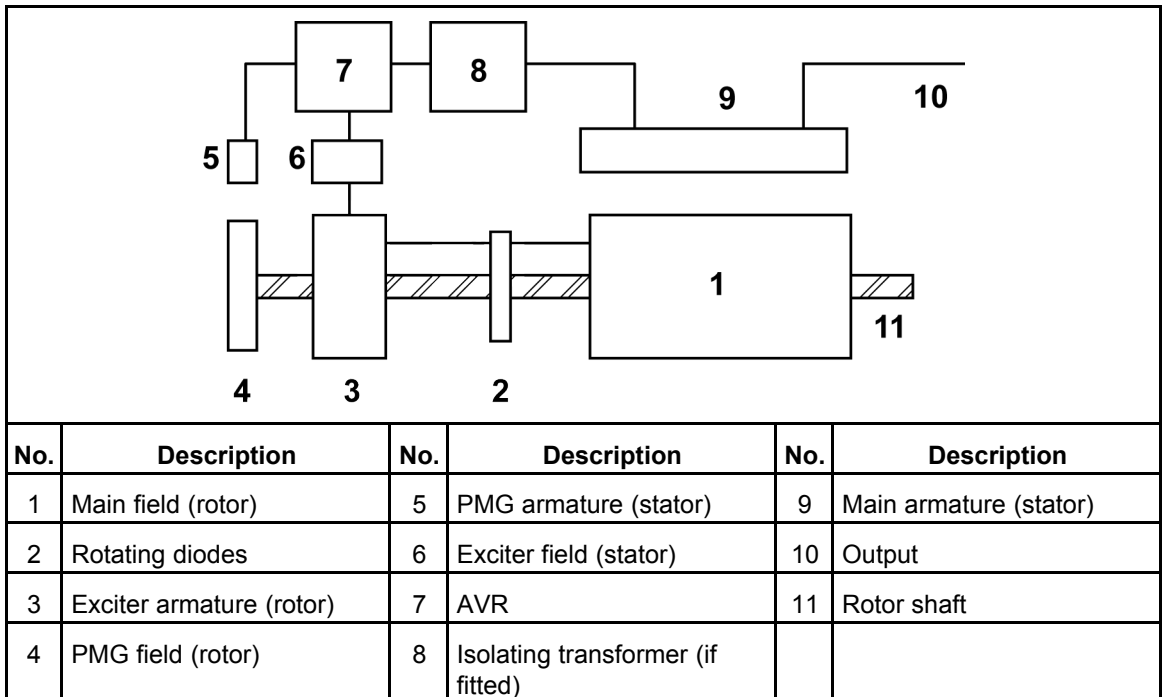

-

This page is intentionally blank.

2 Specification

2.1 MX321™ Technical Specification

- **Sensing Input**
 - Voltage: 190 VAC to 264 VAC maximum, 2 or 3 phase
 - Frequency: 50 Hz to 60 Hz nominal
- **Power Input**
 - Voltage: 170 VAC to 220 VAC maximum, 3 phase, 3 wire
 - Current: 3 A per phase
 - Frequency: 100 Hz to 120 Hz nominal
- **Power Output**
 - Voltage: maximum 120 VDC
 - Current:
 - continuous 3.7 A¹
 - transient 6 A for 10 seconds
 - Resistance: 15 Ω minimum
- **Regulation**
 - +/- 0.5% RMS²
- **Thermal Drift**
 - 0.02% per 1 °C change in AVR ambient temperature³
- **Soft Start Ramp Time**
 - 0.4 s to 4 s
- **Typical Response**
 - AVR response in 10 ms
 - Field current to 90% in 80 ms
 - Machine Volts to 97% in 300 ms
- **External Voltage Adjustment**
 - +/-10% with 5 kΩ, 1 W trimmer⁴
- **Under-Frequency Protection**
 - Set point 95% Hz⁵
 - Slope 100% to 300% down to 30 Hz

¹ De-rate linearly from 3.7 A at 50 °C to 2.7 A at 70 °C

² With 4% engine governing. The stated voltage regulation may not be maintained in the presence of certain transmitted radio signals. Any change in regulation will fall within the limits in Criteria B of BS EN 61000-6-2: 2001

³ After 10 minutes

⁴ Applies to Mod status E onwards. Alternator de-rate may apply. Check with factory

⁵ Factory set, semi-sealed, jumper selectable

-
- Maximum dwell 20% V/s recovery
 - **Unit Power Dissipation**
 - 18 W maximum
 - **Analogue Input**
 - Maximum input: +/- 5 VDC⁶
 - Sensitivity: 1V for 5% Alternator Volts (adjustable)
 - Input resistance 1 k Ω
 - **Quadrature Droop Input**
 - 10 Ω burden
 - Maximum sensitivity: 0.22 A for 5% droop, zero power factor
 - Maximum input: 0.33 A
 - **Current Limit Input**
 - 10 Ω burden
 - Sensitivity range 0.5 A to 1 A
 - **Over-Voltage Detection**
 - Set point: 300 VDC.
 - Time delay: 1 s (fixed)
 - Circuit breaker trip coil voltage: 10 VDC to 30 VDC
 - Circuit breaker trip coil resistance: 20 Ω to 60 Ω
 - **Over-Excitation Protection**
 - Set point: 75 VDC.
 - Time delay: 8 s to 15 s (fixed)
 - **Environmental**
 - Vibration:
 - 20 Hz to 100 Hz: 50 mm/sec
 - 100 Hz to 2 kHz: 3.3 g
 - Operating temperature: -40 °C to +70 °C
 - Relative Humidity 0 °C to 70 °C: 95%⁷
 - Storage temperature: -55 °C to +80 °C

⁶ Any device connected to the analogue input must be fully floating (galvanically isolated from ground), with an insulation strength of 500 VAC

⁷ Non condensing.

3 Controls

⚠ DANGER

Live Electrical Conductors

Live electrical conductors can cause serious injury or death by electric shock and burns.

To prevent injury and before removing covers over electrical conductors, isolate the generator set from all energy sources, remove stored energy and use lock out/tag out safety procedures.

⚠ DANGER

Live Electrical Conductors

Live electrical conductors at output, AVR and AVR accessory terminals, and AVR heat sink can cause serious injury or death by electric shock and burns.

To prevent injury, take suitable precautions to prevent contact with live conductors including personal protective equipment, insulation, barriers and insulated tools.

NOTICE

Refer to alternator wiring daigram for connection details.

⚠ DANGER

Live Electrical Conductors

Live electrical conductors can cause serious injury or death by electric shock and burns.

To prevent injury and before removing covers over electrical conductors, isolate the generator set from all energy sources, remove stored energy and use lock out/tag out safety procedures.

⚠ DANGER

Live Electrical Conductors

Live electrical conductors at output, AVR and AVR accessory terminals, and AVR heat sink can cause serious injury or death by electric shock and burns.

To prevent injury, take suitable precautions to prevent contact with live conductors including personal protective equipment, insulation, barriers and insulated tools.

NOTICE

Refer to alternator wiring diagram for connection details.

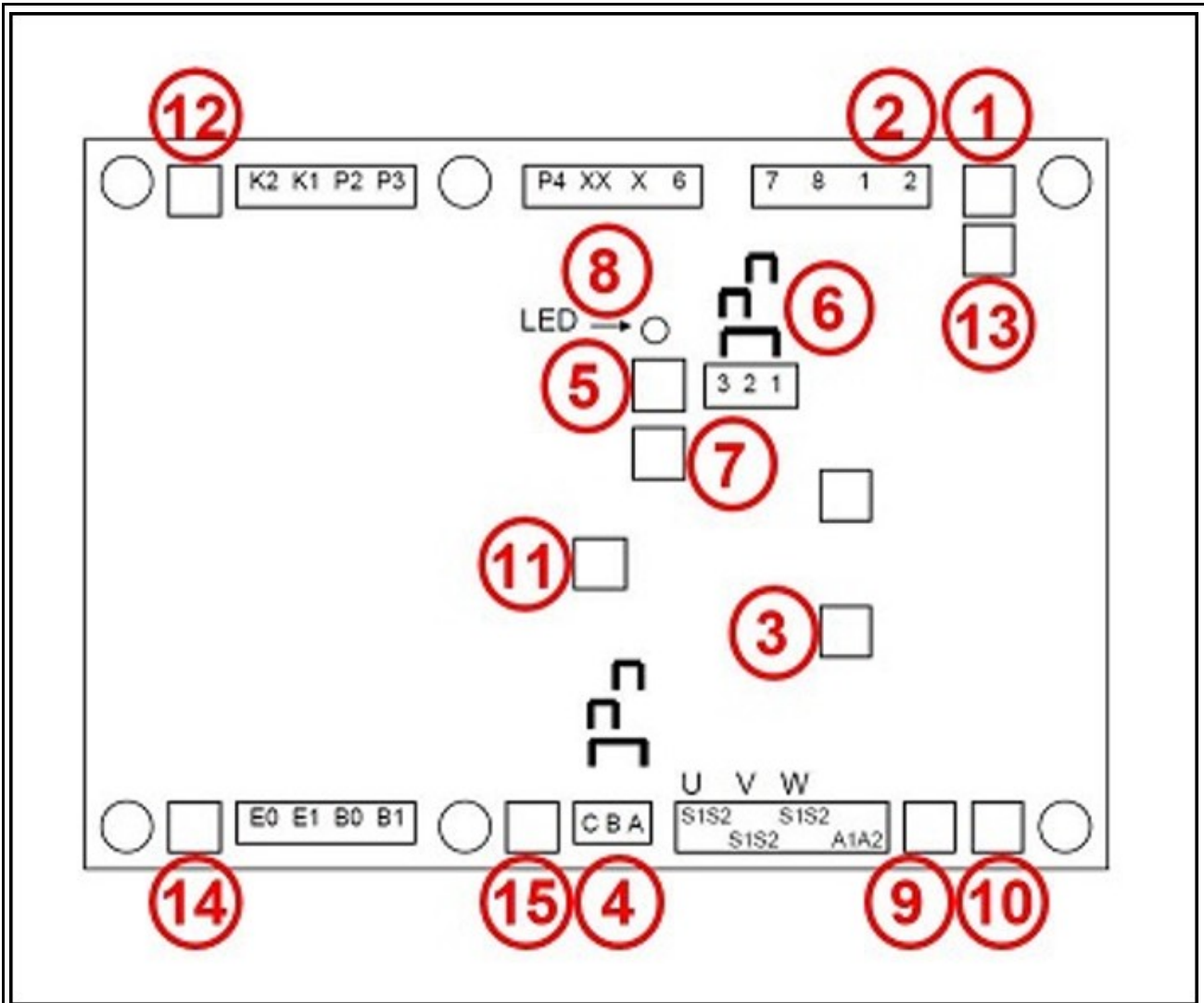

Ref.	Control	Function	Turn potentiometer CLOCKWISE to
1	AVR [VOLTS]	Adjust alternator output voltage	increase voltage
2	Link : Hand trimmer 1-2 : No trimmer None : Trimmer fitted	Adjust alternator output voltage	increase voltage
3	AVR [STAB]	Adjust stability to prevent voltage hunting	increase damping effect
4	Link : Power A-B : > 550 kW B-C : 90-550 kW A-C : < 90 kW	Select stability response for alternator size	N/A
5	AVR [UFRO]	Adjust under-frequency roll-off knee point	reduce UFRO frequency
6	Link : Frequency None : 6 pole 50 Hz 1-2 : 6 pole 60 Hz 2-3 : 4 pole 50 Hz 1-3 : 4 pole 60 Hz	Select alternator frequency for UFRO	N/A
7	AVR [DIP]	Adjust under-frequency voltage dip rate	increase rate

8	Light Emitting Diode	LED lights in UFRO, O/VOLTS or O/EXC condition	N/A
9	AVR [DROOP]	Adjust alternator droop to 5% at zero power factor	increase droop
10	AVR [TRIM]	Adjust analog input sensitivity	increase sensitivity
11	AVR [DWELL]	Adjust voltage recovery	increase recovery time
12	AVR [RAMP]	Adjust soft start voltage ramp	increase ramp time
13	AVR [I LIMIT]	Adjust current limit protection	increase current limit
14	AVR [OVER V]	Adjust over-voltage protection	increase trip voltage
15	AVR [EXC]	Adjust over-excitation protection	increase trip excitation voltage

FIGURE 1. MX321™ AVR CONTROLS

3.2 Initial AVR Setup

NOTICE

The AVR must be setup only by authorised, trained service Personnel. Do not exceed the designed safe operating voltage, shown on the alternator rating plate.

The AVR controls are set at the factory for initial running tests. Check that the AVR settings are compatible with your required output. Do not adjust controls that have been sealed. To set up a replacement AVR, follow these steps:

1. Stop and isolate the generator set.
2. Install and connect the AVR.
3. Turn the **AVR [VOLTS]** volts control [Section 3.3 on page 7](#) fully counter-clockwise.
4. Turn the hand trimmer (if fitted) to 50%, the midway position.
5. Turn the **AVR [STAB]** stability control [Section 3.4 on page 8](#) to 50%, the midway position.
6. Connect a suitable voltmeter (0 to 300 VAC range) between one output phase and neutral.
7. Start the generator set with no load.
8. Adjust speed to nominal frequency (50 to 53 Hz or 60 to 63 Hz).
9. If the LDE is lit, adjust the **AVR [UFRO]** control [Section 3.5 on page 8](#).
10. Carefully turn **AVR [VOLTS]** control clockwise until the voltmeter shows rated voltage.
11. If voltage is unstable, adjust the **AVR [STAB]** stability control.
12. Re-adjust the **AVR [VOLTS]** control, as needed.

3.3 Adjust the AVR [VOLTS] Voltage Control

NOTICE

Do not exceed the designed safe operating voltage, shown on the alternator rating plate.

NOTICE

Hand trimmer terminals may be above earth potential. Do not ground any of the hand trimmer terminals. Grounding hand trimmer terminals could cause equipment damage.

To set the output voltage AVR [VOLTS] control on the AVR:

1. Check the alternator nameplate to confirm the designed safe operating voltage.
2. Set the **AVR [VOLTS]** control to 0%, the fully counter-clockwise position.

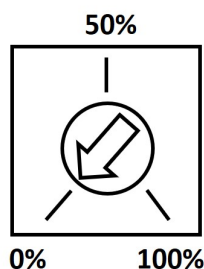

3. Check that the remote hand trimmer is fitted or terminals 1 and 2 are linked.

NOTICE

If a remote hand trimmer is connected, set it to 50%, the midway position.

4. Turn the **AVR [STAB]** control to 50%, the midway position.
5. Start the alternator and set at the correct operating speed.
6. If the red Light Emitting Diode (LED) is illuminated, refer to the Under Frequency Roll Off **AVR [UFRO]** adjustment.
7. Adjust the **AVR [VOLTS]** control slowly clockwise to increase the output voltage.

NOTICE

If the voltage is unstable set the AVR stability before proceeding [Section 3.4 on page 8](#).

8. Adjust the output voltage to the desired nominal value (VAC).
9. If instability is present at rated voltage, refer to the **AVR [STAB]** adjustment, then adjust **AVR [VOLTS]** again, if necessary.
10. If a remote hand trimmer is connected, check its operation.

NOTICE

0% to 100% rotation corresponds to 90% to 110% VAC

The **AVR [VOLTS]** control is now set.

3.4 Adjust the AVR [STAB] Stability Control

3.5 Adjust the AVR [UFRO] Under-Frequency Roll-Off Control

Below an adjustable frequency threshold ('knee' point), the AVR under-speed protection operates to reduce ('roll-off') the excitation voltage in proportion to alternator frequency. The AVR LED lights when UFRO operates.

1. Check the nameplate to confirm the frequency of the alternator.
2. Check that the jumper link or rotary switch selection (depending on AVR type) matches the alternator frequency.
3. Set the **AVR [UFRO]** control to 100%, the fully clockwise position.

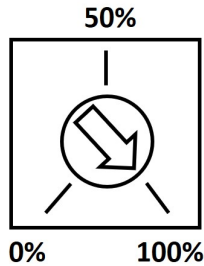

4. Start the alternator and set at the correct operating speed.
5. Verify that the alternator voltage is correct and stable.

NOTICE

If the voltage is high / low / unstable, use method [Section 3.3 on page 7](#) or [Section 3.4 on page 8](#) before proceeding.

6. Reduce the alternator speed to approximately 95% of correct operating speed. i.e. 47.5 Hz for 50 Hz operation, 57.0 Hz for 60 Hz operation.
7. Adjust the **AVR [UFRO]** control slowly counter-clockwise until the AVR LED lights.

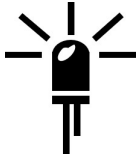

8. Adjust the **AVR [UFRO]** control slowly clockwise until the AVR LED is just OFF.



NOTICE

Do not go past the point at which the LED is just OFF.

9. Adjust the alternator speed back to 100% nominal. The LED should be off.



The **AVR [UFRO]** control is now set.

3.6 Adjust the AVR [DIP] Dip Control

Some generator set prime movers, for example turbocharged engines, have limited capacity to tolerate sudden load increases. The rotational speed, and therefore the frequency of the alternator output, falls below the UFRO setting. The AVR reduces the excitation voltage - and hence the output power - in proportion to the frequency, to allow the prime mover to recover. The **AVR [DIP]** control adjusts the proportion.

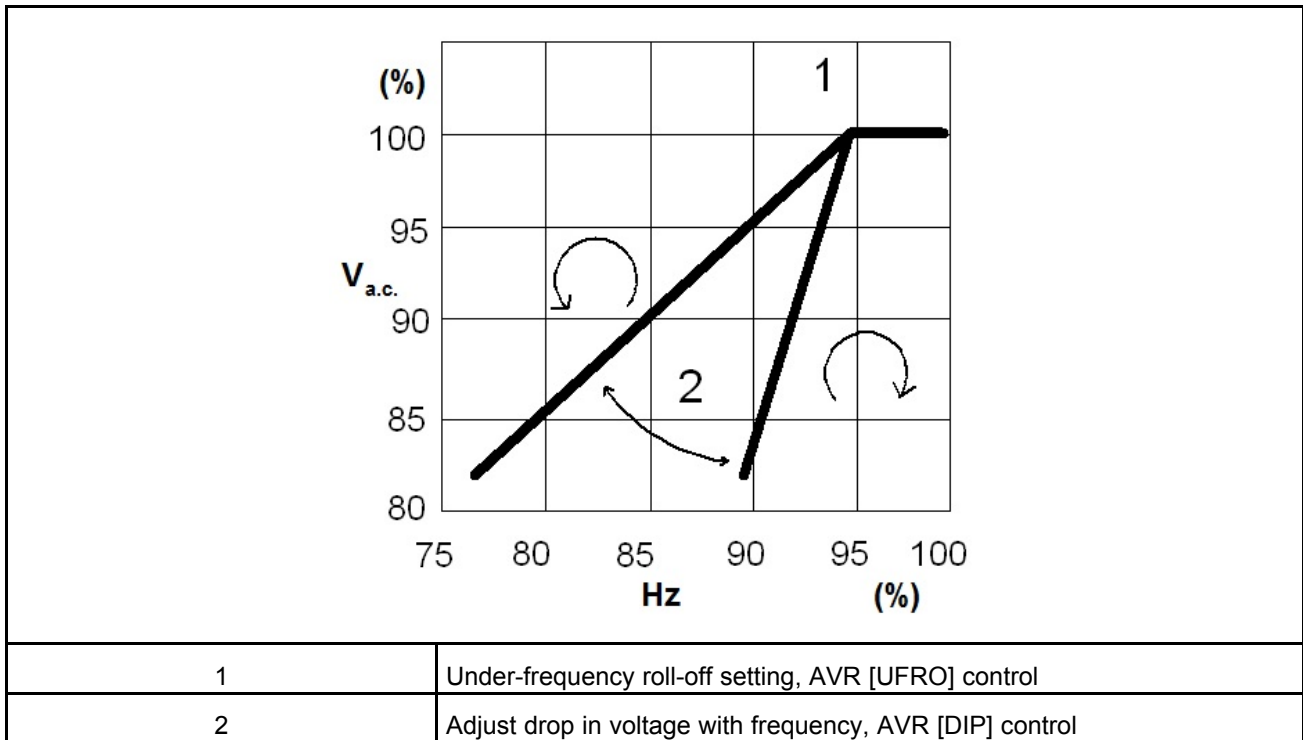

FIGURE 2. EFFECT OF AVR [DIP] CONTROL

1. For the minimum effect (1% fall in frequency gives 1% voltage drop), turn the **AVR [DIP]** control fully counter-clockwise.
2. For the maximum effect (1% fall in frequency gives 3% voltage drop), turn the **AVR [DIP]** control fully clockwise.

3.7 Adjust the AVR [DROOP] Voltage Droop Control for Parallel Operation

A correctly fitted and adjusted droop current transformer (CT) allows the alternator to share reactive current for stable parallel operation.

1. Mount the Droop CT to the correct phase lead of the main output windings of the alternator.
2. Connect the two secondary leads marked S1 and S2 from the CT to the terminals S1 and S2 of the AVR.
3. Turn the **AVR [DROOP]** control to the midway position.
4. Start the alternator(s) and set at the correct operating speed and voltage.
5. Parallel the alternator(s) according to installation rules and procedures.
6. Set the **AVR [DROOP]** control to produce the required balance between individual alternator output currents. Set the AVR droop off-load and then check the currents when the output load is applied, on-load.
7. If the individual alternator output currents rise (or fall) in an uncontrolled way, isolate and stop the alternators then check that:
 - The droop transformer is fitted to the correct phase and in the correct polarity (see the machine wiring diagrams).
 - The droop transformer secondary S1 and S2 leads are connected to the AVR terminals S1 and S2.
 - The droop transformer is the correct rating.

3.8 Adjust the AVR [TRIM] Trim Control

NOTICE

AVR analog inputs must be fully floating (galvanically isolated from ground), with an insulation strength of 500 V a.c. to avoid equipment damage.

An analog input (-5 VDC to +5 VDC) modifies the AVR excitation voltage, by adding to, or subtracting from, the sensed alternator voltage. A Stamford Power Factor Controller (PFC3) can provide such an input. The **AVR [TRIM]** control adjusts the effect.

1. Connect the analog input from the PFC3, or similar, to terminals A1 and A2 of the AVR. Terminal A1 is connected to AVR zero volts. Positive voltage connected to A2 increases AVR excitation, negative voltage connected to A2 decreases AVR excitation.
2. Turn the **AVR [TRIM]** control to the desired position. The analog signal has no effect on excitation when the **AVR [TRIM]** control is fully counter-clockwise, and maximum effect when fully clockwise.

3.9 Adjust the AVR [OVER V] Over-Voltage Control

NOTICE

The AVR [OVER V] control is set and sealed at the factory to protect the alternator from over-voltage. Incorrect AVR [OVER V] control setting could damage the alternator.

The AVR protects the alternator by removing excitation if it senses that the alternator output voltage exceeds a threshold set by the **AVR [OVER V]** control.

1. If the alternator output voltage exceeds the over-voltage setting, the red LED on the AVR turns on.
2. After a short time, the AVR removes the excitation voltage and the red LED flashes (which can also indicate an over-excitation trip or UFRO operation).
3. Stop the alternator to reset the over-voltage condition.

3.10 Adjust the AVR [DWELL] Dwell Control

Some generator set prime movers, for example turbocharged engines, have limited capacity to tolerate sudden load increases. The AVR introduces a time delay before increasing the excitation voltage after an under-frequency condition, to allow the prime mover to recover. The **AVR [DWELL]** control adjusts the proportion.

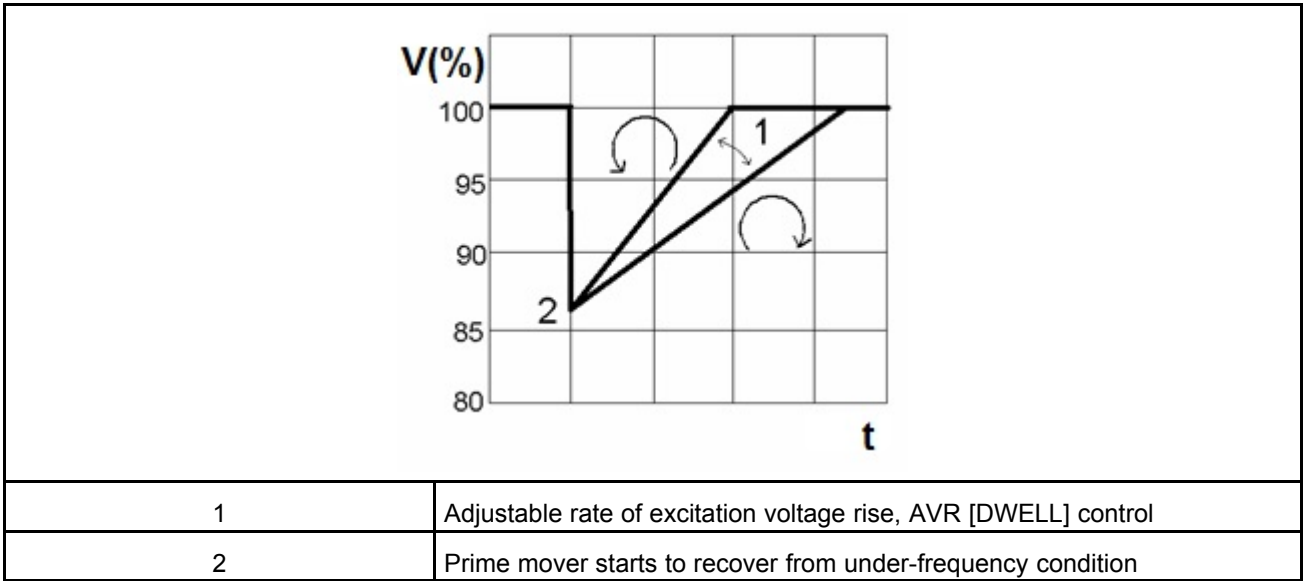

FIGURE 3. EFFECT OF AVR [DWELL] CONTROL

1. For the minimum effect (excitation voltage follows speed according to UFRO V/Hz ramp), turn the **AVR [DWELL]** control fully counter-clockwise.
2. For the maximum effect (excitation voltage lags speed increase by several seconds), turn the **AVR [DWELL]** control fully clockwise.

3.11 Adjust the AVR [RAMP] Dwell Control

The AVR includes a soft start circuit to control the rate of excitation voltage rise, as the alternator starts and runs up to speed. The **AVR [RAMP]** control adjusts the rate.

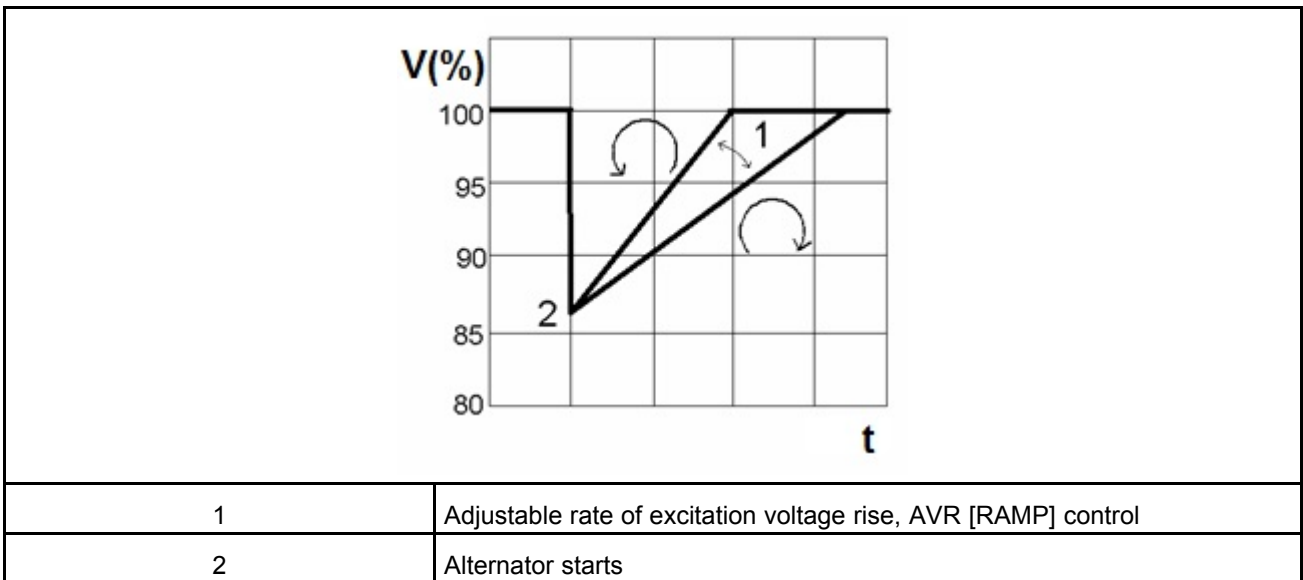

FIGURE 4. EFFECT OF AVR [RAMP] CONTROL

1. For the minimum effect (excitation voltage reaches 100% in about 0.5s), turn the **AVR [RAMP]** control fully counter-clockwise.
2. For the maximum effect (excitation voltage reaches 100% in about 4.0s), turn the **AVR [RAMP]** control fully clockwise.

3.12 Adjust the AVR [EXC] Over-Excitation Control

NOTICE

The AVR [EXC] control is set and sealed at the factory to protect the alternator from over-excitation, usually caused by overload. Incorrect AVR [EXC] control setting could damage the alternator rotor components.

The AVR protects the alternator by removing excitation if it senses that the excitation voltage exceeds a threshold set by the **AVR [EXC]** control.

1. If the excitation voltage exceeds the over-excitation trip setting, the red LED on the AVR turns on.
2. After a short time, the AVR removes the excitation voltage and the red LED flashes (which can also indicate an over-voltage trip or UFRO operation).
3. Stop the alternator to reset the over-excitation condition.

3.13 Current Limiting Transformers

Alternator main output current can be electronically limited by connecting additional current transformers to the MX321™ AVR. In any situation where the output current attempts to rise above a preset threshold (set on AVR) then the AVR will reduce the terminal voltage to restore the set current level. For unbalanced loads, operation is based on the highest of the three phase currents.

-

This page is intentionally blank.

4 Accessories

4.1 Diode Failure Detector

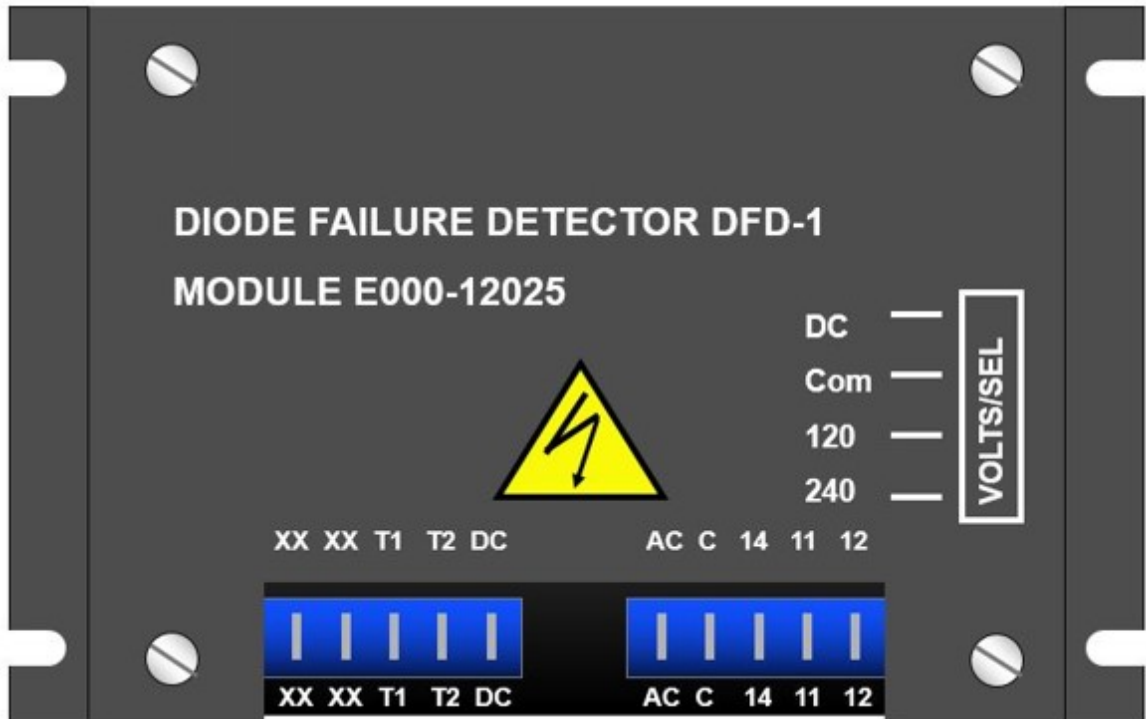

4.1.2 Description

The STAMFORD Diode Failure Detector (DFD) senses ripple current in the exciter output caused by diode failure in short or open circuit, and switches an internal relay if it persists for 7 seconds.

The changeover contacts of the relay can be wired to provide a warning indication of diode failure or initiate an automatic shutdown.

Where the DFD triggers a warning, monitor the exciter field current or voltage and reduce load as necessary, so that the generator set can continue to run until a planned controlled shutdown to replace the diode.

Key features include:

- Robust and reliable solid-state electronics
- Built-in test function
- Selectable power supply
- Simple connection to the alternator.

4.1.3 Specification

- **Sensing Input**
 - Voltage: 0 VDC to 150 VDC
 - Input resistance: 100 k Ω
 - Sensitivity: 50 V peak

- **Power Supply**
 - Voltage: 12 VDC to 28 VDC
 - Voltage: 100 VAC to 140 VAC
 - Voltage: 200 VAC to 280 VAC
 - Current: 0.2 A maximum
- **Output**
 - Single pole changeover relay rating: 5 A @ 30 VDC, 5 A @ 240 VAC
 - Isolation: 2 kV
 - Volt-free contacts
- **Time Delays**
 - Response time: 7 s (approximately)
- **Environmental**
 - Vibration: 30 mm/s @ 20 Hz to 100 Hz, 2 g @ 100 Hz to 2 kHz
 - Relative humidity: 95%⁸
 - Storage temperature: -55 °C to +80 °C
 - Operating temperature: -40 °C to +70 °C.

4.1.4 Controls

DANGER

Live Electrical Conductors

Live electrical conductors can cause serious injury or death by electric shock and burns.

To prevent injury and before removing covers over electrical conductors, isolate the generator set from all energy sources, remove stored energy and use lock out/tag out safety procedures.

DANGER

Live Electrical Conductors

Live electrical conductors at output, AVR and AVR accessory terminals, and AVR heat sink can cause serious injury or death by electric shock and burns.

To prevent injury, take suitable precautions to prevent contact with live conductors including personal protective equipment, insulation, barriers and insulated tools.

NOTICE

Refer to alternator wiring diagram for connection details. Mount the DFD on a switchboard or bedplate, not in the alternator terminal box.

⁸ Non-condensing

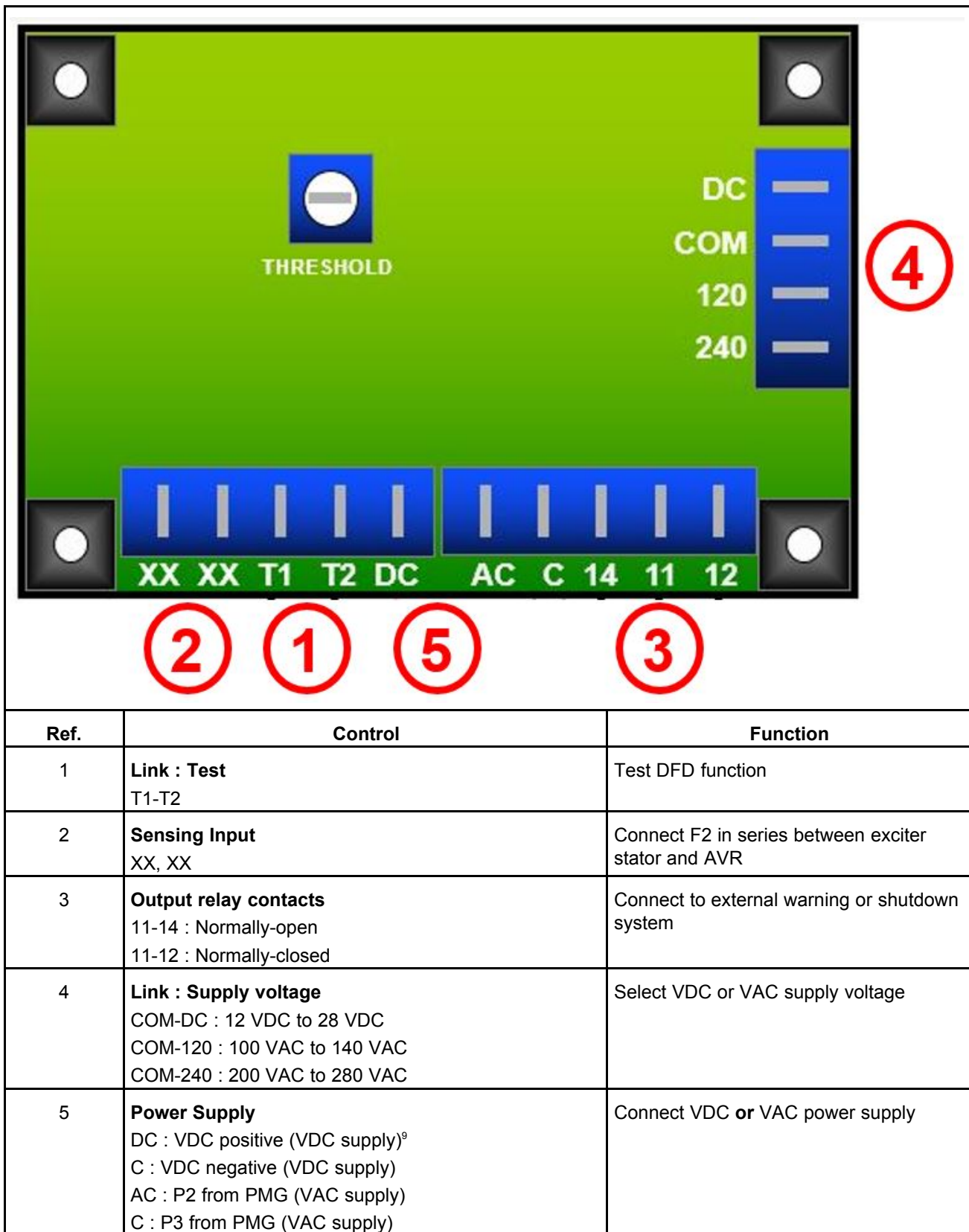

FIGURE 5. DIODE FAILURE DETECTOR CONTROLS

⁹ disconnect to reset DFD

4.2 Dual AVR Unit

4.2.1 Description

The STAMFORD dual AVR unit (DAU) has two MX321™ AVRs arranged for manual switching. If an AVR fails, regulation can be switched to the other AVR, so that the generator set can continue to run until a planned controlled shutdown to replace the faulty AVR. The supplied 6 pole changeover switch can be panel-mounted or substituted by another of equivalent rating and preferred design.

Both AVRs are wired to terminals at a terminal block, grouped for easy connection; to the alternator, to optional current transformers for paralleling and/or short circuit protection, and to hand trimmers.

Key features include:

- Robust and reliable solid-state electronics
- Built-in changeover switch
- Simple connection to the alternator.

4.2.2 Specification

- **Sensing Input**
 - Paralleling: quadrature droop current transformer (CT) in W phase¹⁰
 - Short circuit protection: current transformer in U, V and W phases
- **Manual Switch**
 - 6 pole changeover switch contact rating: 5 A @ 240 VAC
 - Power dissipation: 6 W maximum
- **Environmental**
 - Vibration: 30 mm/s @ 20 Hz to 100 Hz, 2 g @ 100 Hz to 2 kHz
 - Relative humidity: 95%¹¹
 - Storage temperature: -55 °C to +80 °C
 - Operating temperature: -40 °C to +70 °C.

4.2.3 Controls

 **DANGER**

Live Electrical Conductors

Live electrical conductors can cause serious injury or death by electric shock and burns.

To prevent injury and before removing covers over electrical conductors, isolate the generator set from all energy sources, remove stored energy and use lock out/tag out safety procedures.

 **DANGER**

Live Electrical Conductors

Live electrical conductors at output, AVR and AVR accessory terminals, and AVR heat sink can cause serious injury or death by electric shock and burns.

To prevent injury, take suitable precautions to prevent contact with live conductors including personal protective equipment, insulation, barriers and insulated tools.

¹⁰ same CT can be used for short circuit protection.

¹¹ Non-condensing

NOTICE

Refer to alternator wiring diagram for connection details. Mount the DAU on a switchboard or bedplate.

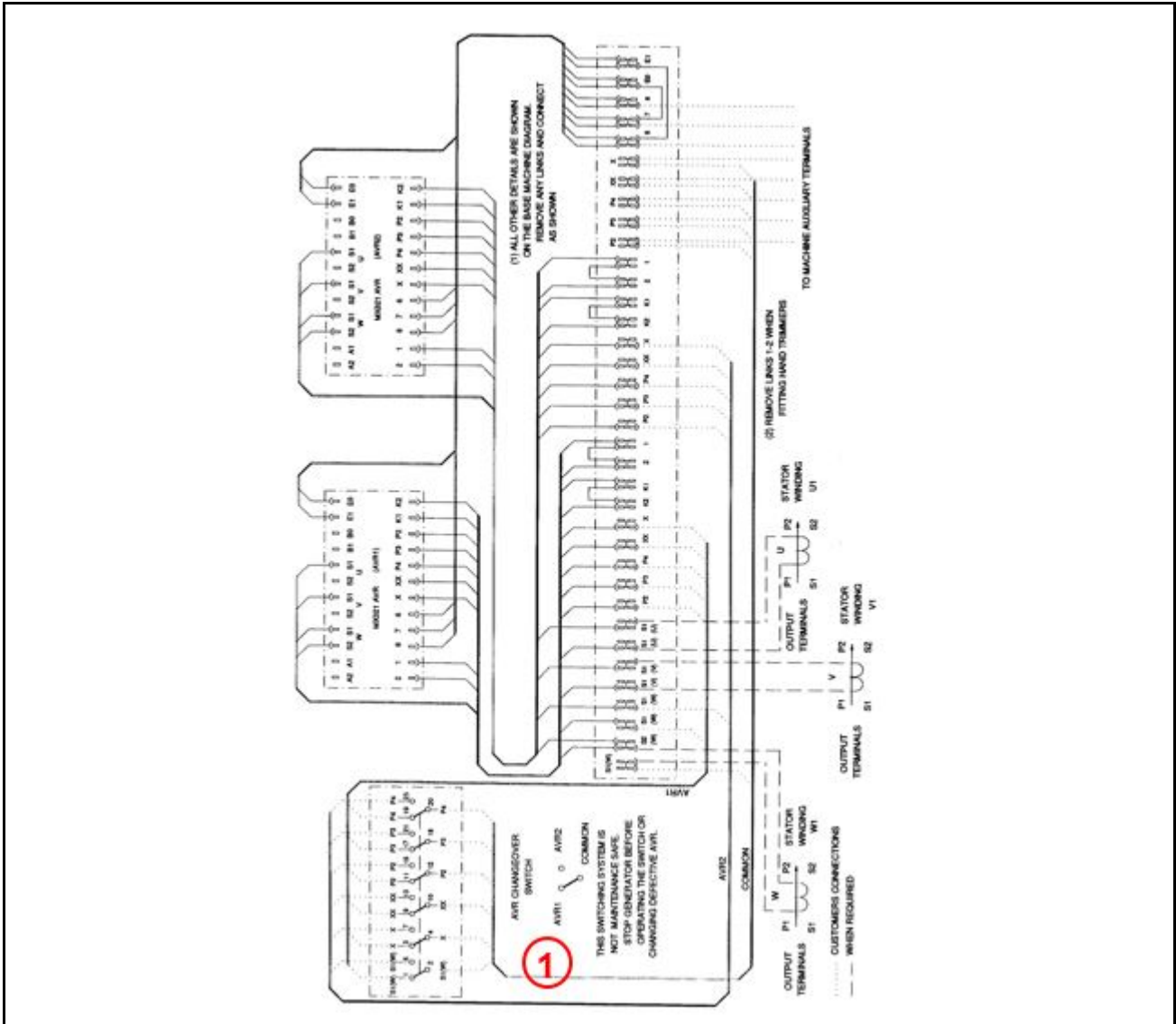

Ref.	Control	Function
1	AVR Select Switch	AVR1 : alternator regulated by AVR1. See Chapter 3 to set up AVR1. AVR2 : alternator regulated by AVR2. See Chapter 3 to set up AVR2.

FIGURE 6. DUAL AVR UNIT CONTROLS

4.3 Excitation Loss Module



4.3.2 Description

A loss of alternator excitation during parallel operation will result in heavy circulating currents, pole-slipping (loss of synchronization), and torque/current surges and oscillation. The STAMFORD Excitation Loss Module (ELM) monitors the alternator AVR output and signals any sustained interruption to an integral relay to initiate an indication/alarm.

The ELM has been specially designed for use with all Stamford AVRs. It is powered independently from the engine battery at 12 VDC or 24 VDC. It operates by detecting the absence of the characteristic 'rectifier ripple' in the exciter field voltage. An optical isolator ensures complete electrical isolation between the exciter field circuit and the engine battery system. Any loss of AVR output is recognised immediately by the monitoring circuit, and if the interruption persists for more than about a second the module output energises an integral relay. The changeover contacts can either provide remote indication of the excitation failure or operate any other relay-fed protective device. The system incorporates a time delay to prevent spurious tripping on transients and an eight-second engine-start lock-out that can be overridden.

Key features include:

- Robust and reliable solid-state electronics
- Independently-powered from the engine battery
- Power supply is completely isolated from exciter field
- Engine-start lock-out time delay.

4.3.3 Specification

- **Sensing Input**
 - Voltage: 0 VDC to 150 VDC
 - Input resistance: 100 kΩ
 - Sensitivity: 50 V peak
- **Power Input**
 - Voltage: 10 VDC to 14 VDC (ELM 12V version)
 - Voltage: 20 VDC to 28 VDC (ELM 24V version)
 - Current: 25 mA max. in standby (both versions)
 - Relay on: 150 mA maximum (ELM 12V version)
 - Relay on: 60 mA maximum (ELM 24V version)
- **Output**
 - Single pole changeover relay rating: 5 A @ 30 VDC, 5 A @ 240 VAC
 - Power dissipation: 3 W maximum
- **Time Delays**
 - Response time: 1.5 s to 2 s
 - Power up delay: 8 s to 15 s
- **Environmental**
 - Vibration: 30 mm/s @ 20 Hz to 100 Hz, 2 g @ 100 Hz to 2 kHz
 - Relative humidity: 95%¹²
 - Storage temperature: -55 °C to +80 °C
 - Operating temperature: -40 °C to +70 °C.

4.3.4 Controls

DANGER

Live Electrical Conductors

Live electrical conductors can cause serious injury or death by electric shock and burns.

To prevent injury and before removing covers over electrical conductors, isolate the generator set from all energy sources, remove stored energy and use lock out/tag out safety procedures.

DANGER

Live Electrical Conductors

Live electrical conductors at output, AVR and AVR accessory terminals, and AVR heat sink can cause serious injury or death by electric shock and burns.

To prevent injury, take suitable precautions to prevent contact with live conductors including personal protective equipment, insulation, barriers and insulated tools.

NOTICE

Refer to alternator wiring diagram for connection details. Mount the ELM on a switchboard or bedplate, not in the alternator terminal box.

¹² Non-condensing

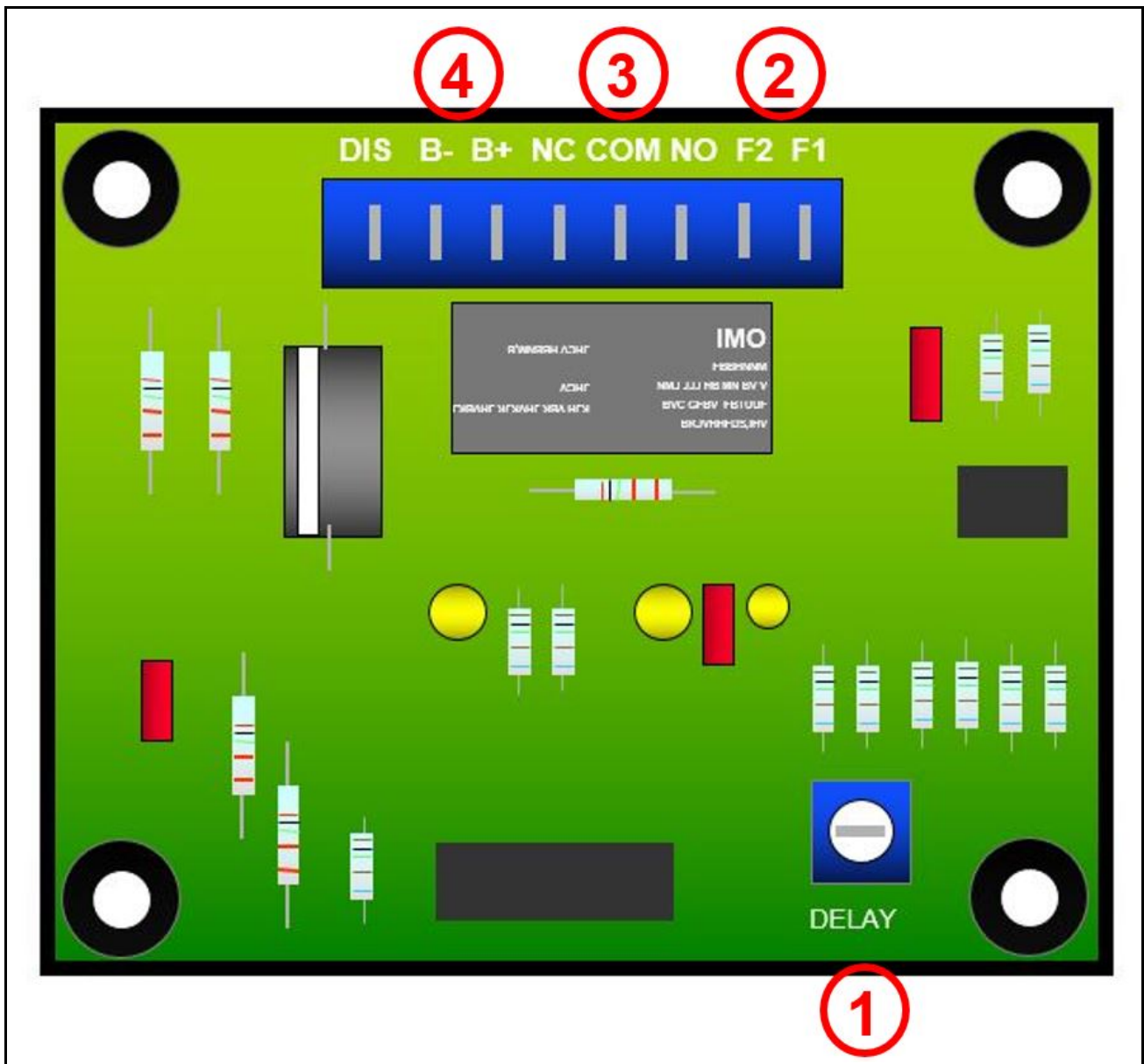

Ref.	Control	Function	Turn potentiometer CLOCKWISE to
1	DELAY	Adjust time delay	increase delay to operate relay
2	Sensing Input F1, F2	Connect to exciter stator	N/A
3	Output relay contacts COM-NO : Normally-open COM-NC : Normally-closed	Connect to external control system	N/A
4	Power Input B- : Battery negative B+ : Battery positive	Connect to engine battery	N/A

FIGURE 7. EXCITATION LOSS MODULE CONTROLS

4.4 Frequency Detection Module

4.4.1 Description

The STAMFORD Frequency Detection Module (FDM) is used with a separately-excited alternator, deriving an alternator frequency (rotational speed) signal from the Permanent Magnet Generator (PMG).

The FDM operates a relay if the frequency falls below an adjustable preset under-frequency threshold. Changeover contacts can be used for engine control to disengage a starter motor, for example.

The FDM operates a relay if the frequency rises above an adjustable preset over-frequency threshold. Changeover contacts can be used for engine control to initiate an over-speed shutdown.

Key features include:

- Robust and reliable solid-state electronics
- Independently powered from the engine battery
- Simple connection to the alternator.

4.4.2 Specification

- **Sensing Input**
 - Voltage: 20 VAC to 300 VAC
 - Frequency: 100 Hz @ 1500 RPM
 - Optical isolation: 2 kV
- **Power Input**
 - Voltage: 10 VDC to 16 VDC (FDM 12VDC version)
 - Voltage: 20 VDC to 32 VDC (FDM 24VDC version)
 - Current: 200 mA maximum (FDM 12VDC version)
 - Current: 100 mA maximum (FDM 24VDC version)
- **Output**
 - Single pole changeover relay rating: 5 A @ 30 VDC, 5 A @ 240 VAC
 - Optical isolation: 2 kV
- **Preset Range**
 - Under-frequency: 300 RPM to 1800 RPM
 - Over-frequency: 1500 RPM to 2500 RPM
- **Environmental**
 - Vibration: 30 mm/s @ 20 Hz to 100 Hz, 2 g @ 100 Hz to 2 kHz
 - Relative humidity: 95%¹³
 - Storage temperature: -55 °C to +80 °C
 - Operating temperature: -40 °C to +70 °C.

¹³ Non-condensing

4.4.3 Controls

⚠ DANGER

Live Electrical Conductors

Live electrical conductors can cause serious injury or death by electric shock and burns.

To prevent injury and before removing covers over electrical conductors, isolate the generator set from all energy sources, remove stored energy and use lock out/tag out safety procedures.

⚠ DANGER

Live Electrical Conductors

Live electrical conductors at output, AVR and AVR accessory terminals, and AVR heat sink can cause serious injury or death by electric shock and burns.

To prevent injury, take suitable precautions to prevent contact with live conductors including personal protective equipment, insulation, barriers and insulated tools.

NOTICE

Refer to alternator wiring diagram for connection details. Mount the FDM on a switchboard or bedplate, not in the alternator terminal box.

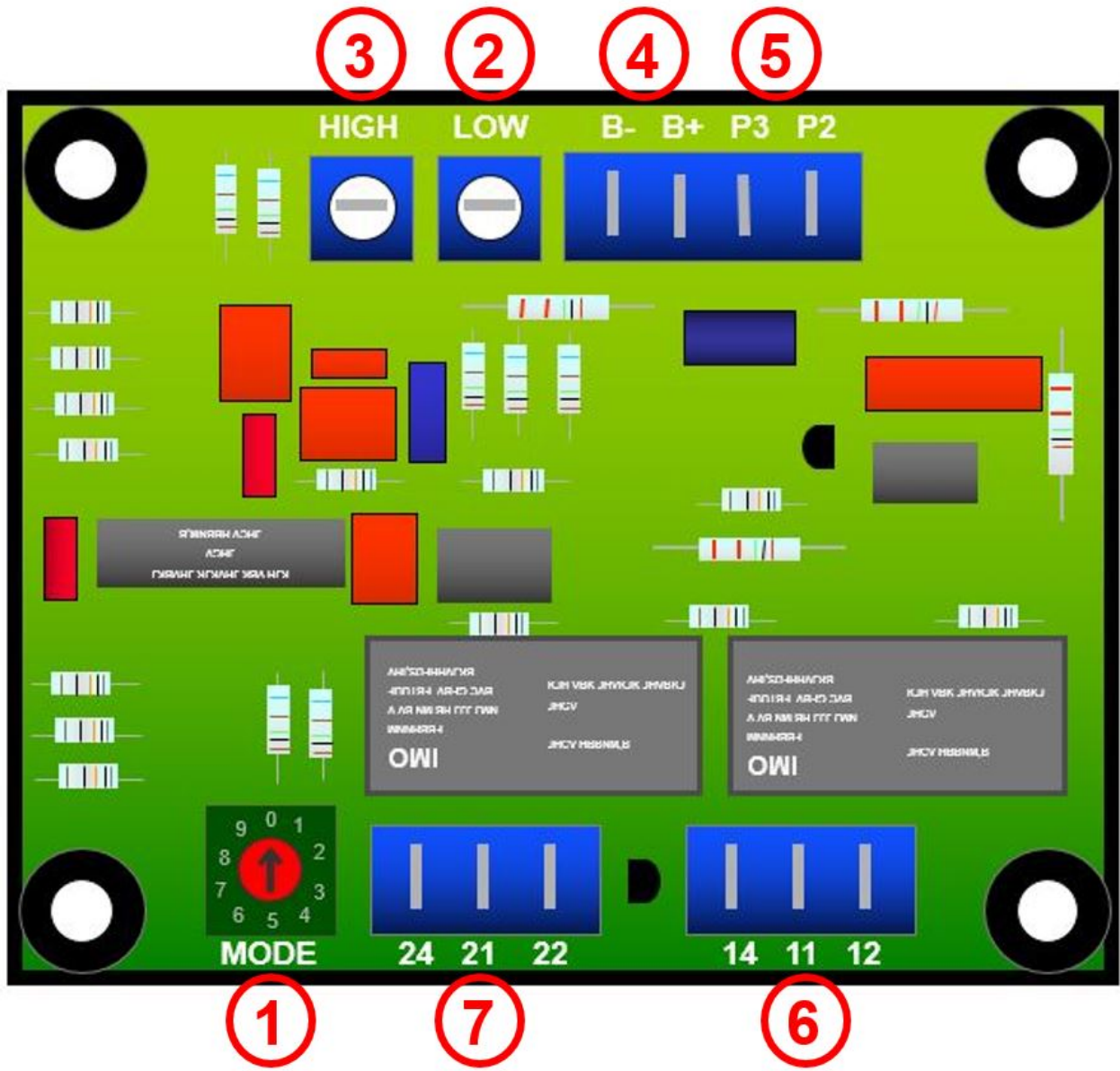

Ref.	Control	Function	Turn potentiometer CLOCKWISE to
1	MODE	Select under-frequency relay mode 0 = relay energised at rest 1 = relay de-energised at rest	N/A
2	LOW	Adjust under-frequency threshold	increase frequency to operate relay
3	HIGH	Adjust over-frequency threshold	increase frequency to operate relay
4	Power Input B- : Battery negative B+ : Battery positive	Connect to engine battery	N/A
5	Sensing Input P2, P3	Connect to PMG	N/A

6	Output relay contacts 11-14 : Normally-open 11-12 : Normally-closed	Connect to under-frequency external control system	N/A
7	Output relay contacts 21-24 : Normally-open 21-22 : Normally-closed	Connect to over-frequency external control system	N/A

FIGURE 8. FREQUENCY DETECTION MODULE CONTROLS

4.5 Manual Voltage Regulator

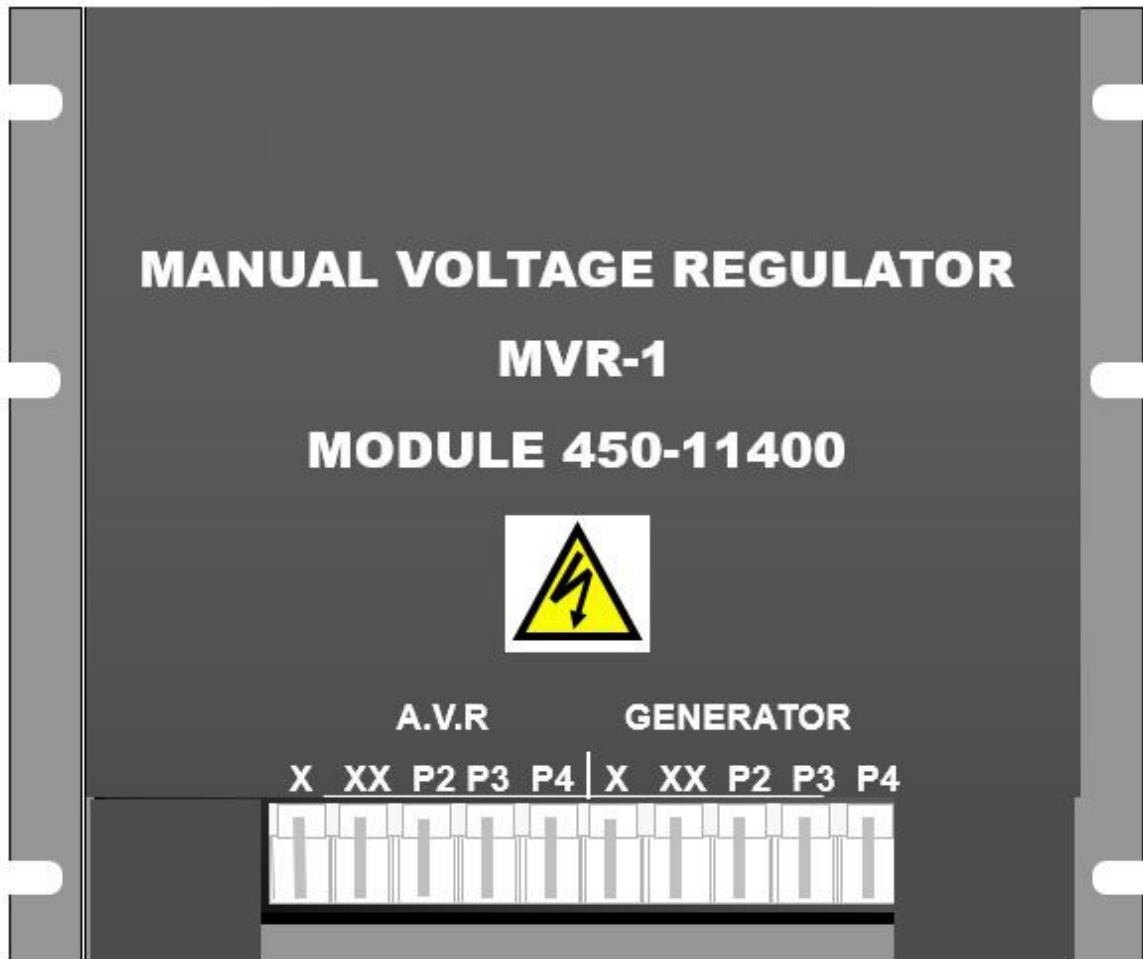

4.5.2 Description

The STAMFORD Manual Voltage Regulator (MVR) automatically controls alternator current output to a manually-set constant, independent of alternator voltage or frequency.

A manually-controlled excitation system can be useful if the AVR fails. Although not practicable for stand-alone operation, a manually-controlled alternator can operate in parallel with another alternator whose AVR is healthy. Manual control can also provide a controlled level of short-circuit current for:

- drying-out windings or setting protective devices
- frequency starting of relatively large motors (where an electrically-connected alternator and motor are run up together from rest)
- dynamometer loading of motors or engines, and
- control of static loads (e.g. variable-intensity lighting).

An MVR is used with a separately-excited AVR, and powered from the same permanent-magnet generator (PMG). PMG-powered systems offer reliable build-up and sustained short-circuit current for flexibility and operational stability.

Key features include:

- Robust and reliable solid-state electronics
- Manually-set automatic field current control
- Dependable power supply from PMG.

The MVR has three switch-selectable modes:

- Auto, with the AVR maintaining a pre-set alternator output voltage
- Off, with zero exciter stator current
- Manual, with a manually-set exciter stator current, automatically maintained.

A mode can be changed while the alternator is running without damage to MVR or AVR, but the effects on the alternator and any connected load must be monitored. An external lamp or relay can be connected across two of the AVR terminals to show when the MVR is in Auto mode.

4.5.3 Specification

- **Power Input from PMG**
 - Voltage: 150 VAC to 220 VAC, three phase
 - Frequency: 67 Hz to 120 Hz (depending on alternator speed)
- **Regulated Output**
 - 0.25 A to 2.0 A, minimum 20 Ω
- **Power Dissipation**
 - 6 W maximum
 - Power up delay: 8 s to 15 s
- **Environmental**
 - Vibration: 30 mm/s @ 20 Hz to 100 Hz, 2 g @ 100 Hz to 2 kHz
 - Relative humidity: 95%¹⁴
 - Storage temperature: -55 °C to +80 °C
 - Operating temperature: -40 °C to +70 °C.

4.5.4 Controls

 **DANGER**

Live Electrical Conductors

Live electrical conductors can cause serious injury or death by electric shock and burns.

To prevent injury and before removing covers over electrical conductors, isolate the generator set from all energy sources, remove stored energy and use lock out/tag out safety procedures.

¹⁴ Non-condensing

⚠ DANGER

Live Electrical Conductors

Live electrical conductors at output, AVR and AVR accessory terminals, and AVR heat sink can cause serious injury or death by electric shock and burns.

To prevent injury, take suitable precautions to prevent contact with live conductors including personal protective equipment, insulation, barriers and insulated tools.

NOTICE

Refer to alternator wiring diagram for connection details. Mount the ELM on a switchboard or bedplate, not in the alternator terminal box.

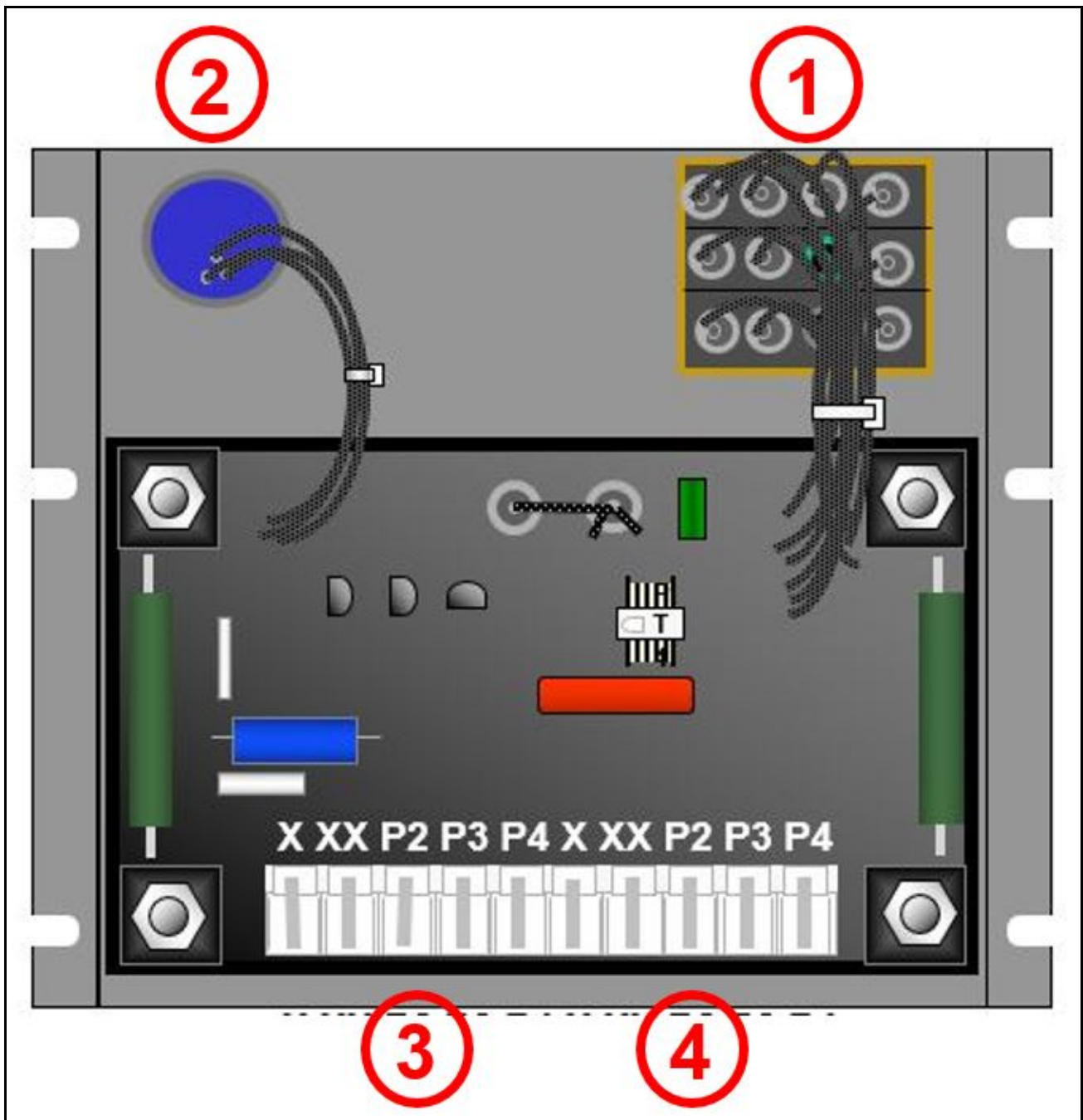

Ref.	Control	Function
1	Mode Select Switch	AUTO : exciter stator current controlled by AVR OFF : zero exciter stator current MANUAL : exciter stator current set by excitation control potentiometer
2	Excitation control potentiometer	Set exciter stator current in Manual mode
3	X, XX : exciter stator P2, P3, P4 : power supply from PMG	Connections to AVR
4	X, XX : exciter stator P2, P3, P4 : power supply	

		Connections to alternator
	from PMG	

FIGURE 9. MANUAL VOLTAGE REGULATOR CONTROLS

4.6 Remote Control Interface

4.6.1 Description

The STAMFORD Remote Control Interface (RCI) is used with a STAMFORD Automatic Voltage Regulator (AVR) or a STAMFORD Power Factor Controller (PFC3) to control the alternator voltage or power factor (respectively) remotely.

The RCI has two inputs which accept unipolar 4-20Ma or bipolar 0-10 volt signals to control alternator power factor from 0.7 lag to 0.7 lead or alternator voltage up to +/- 10%. The input circuitry is fully floating for maximum application flexibility. Loss of the control signal provides a default Unity Power Factor setting or returns the voltage to the AVR no-load setting.

The RCI allows the power factors of alternators running in parallel to be controlled automatically from a convenient remote location, to suit local site conditions.

The RCI allows the voltage of several alternators to be matched simultaneously with one signal, to allow voltage matching before paralleling.

Key features include:

- Robust and reliable solid-state electronics
- Industry standard interfaces to control equipment
- Selectable power supply from alternator output
- Simple connection to the alternator.

4.6.2 Specification

- **Control Input**
 - Voltage: 0 VDC to 10 VDC, input resistance 100 Ω
 - Current: 4 mA to 20 mA, input resistance 38 k Ω ¹⁵
 - Optical isolation: 1 kV input to output
- **Power Input**
 - Voltage: 110 VAC to 125 VAC, 50 Hz to 60 Hz
 - Voltage: 200 VAC to 230 VAC, 50 Hz to 60 Hz
 - Voltage: 231 VAC to 250 VAC, 50 Hz to 60 Hz
 - Voltage: 251 VAC to 290 VAC, 50 Hz to 60 Hz
 - Power: 5 VA
- **Output**
 - Single pole changeover relay rating: 5 A @ 30 VDC, 5 A @ 240 VAC
 - Optical isolation: 2 kV
- **Preset Range**
 - Power factor control: 0.7 lead (4 mA) to 0.7 lag (20 mA) or 0.7 lead (-10 VDC) to 0.7 lag (+10 VDC)¹⁶

¹⁵ Use twisted pair, screened cables separated from power. Apply control input smoothly with alternator at rest, from default 12 mA. To allow the PFC3 to compensate after voltage matching, return the control input smoothly to 12 mA in not less than 15 seconds.

¹⁶ see [Figure 10](#) for response

- Voltage control: -10% (4 mA) to +10% (20 mA) or -10% (-10 VDC) to +10% (+10 VDC)^{17,18}
- Response time constant: less than 20 ms
- **Environmental**
 - Vibration: 50 mm/s @ 10 Hz to 100 Hz, 4.4 g @ 100 Hz to 300 Hz
 - Relative humidity: 95%¹⁹
 - Storage temperature: -55 °C to +80 °C
 - Operating temperature: -40 °C to +70 °C.

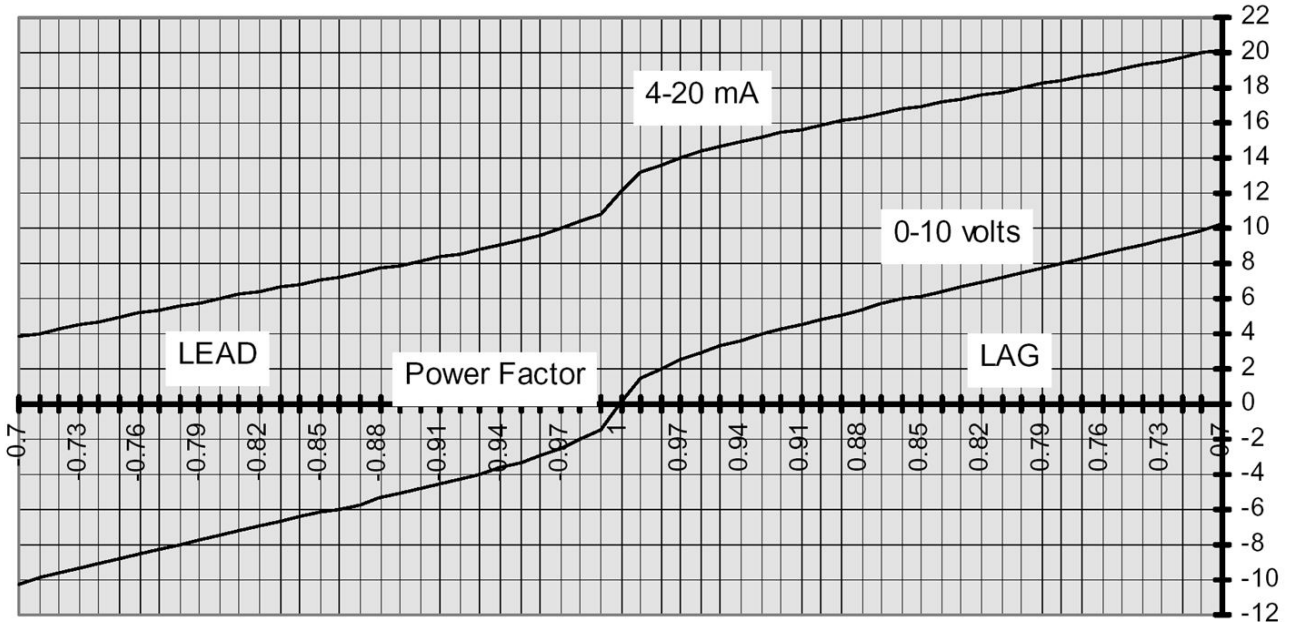

FIGURE 10. POWER FACTOR RESPONSE TO CONTROL INPUTS

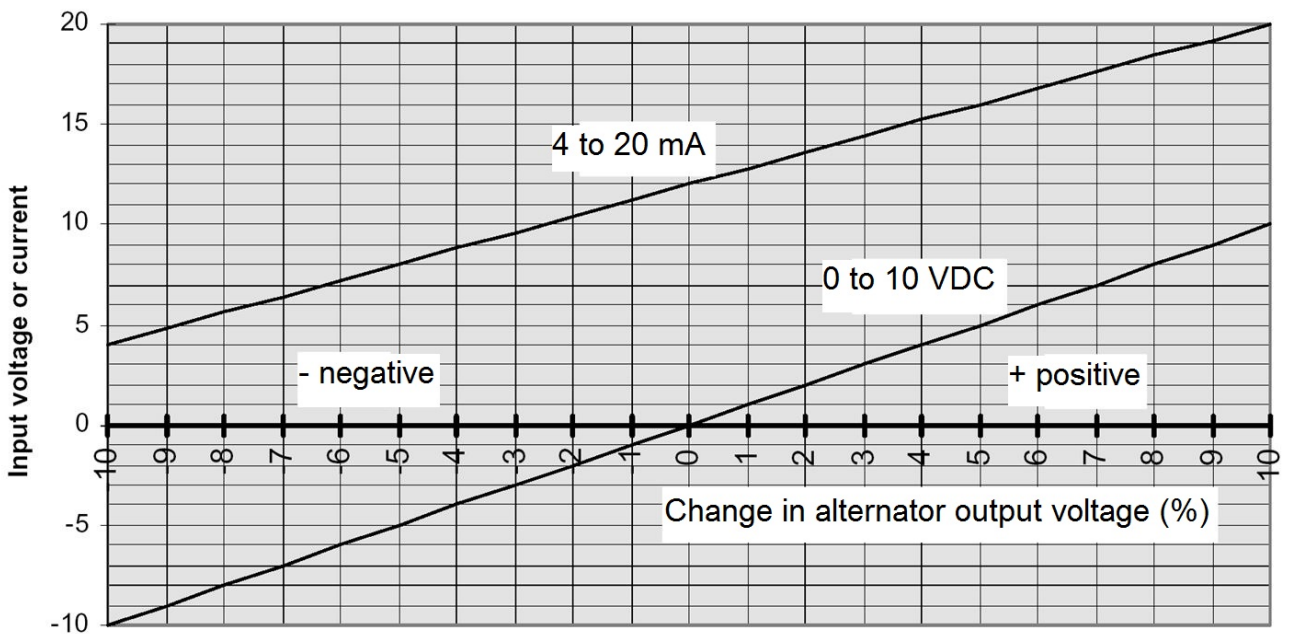

FIGURE 11. VOLTAGE RESPONSE TO CONTROL INPUTS

¹⁷ see [Figure 11](#) for response

¹⁸ Depends on AVR type and VTRIM setting.

¹⁹ Non-condensing

4.6.3 Controls

 **DANGER**

Live Electrical Conductors

Live electrical conductors can cause serious injury or death by electric shock and burns.

To prevent injury and before removing covers over electrical conductors, isolate the generator set from all energy sources, remove stored energy and use lock out/tag out safety procedures.

 **DANGER**

Live Electrical Conductors

Live electrical conductors at output, AVR and AVR accessory terminals, and AVR heat sink can cause serious injury or death by electric shock and burns.

To prevent injury, take suitable precautions to prevent contact with live conductors including personal protective equipment, insulation, barriers and insulated tools.

NOTICE

Refer to alternator wiring diagram for connection details. Mount the RCI on a standard AVR chassis with anti-vibration mounts.

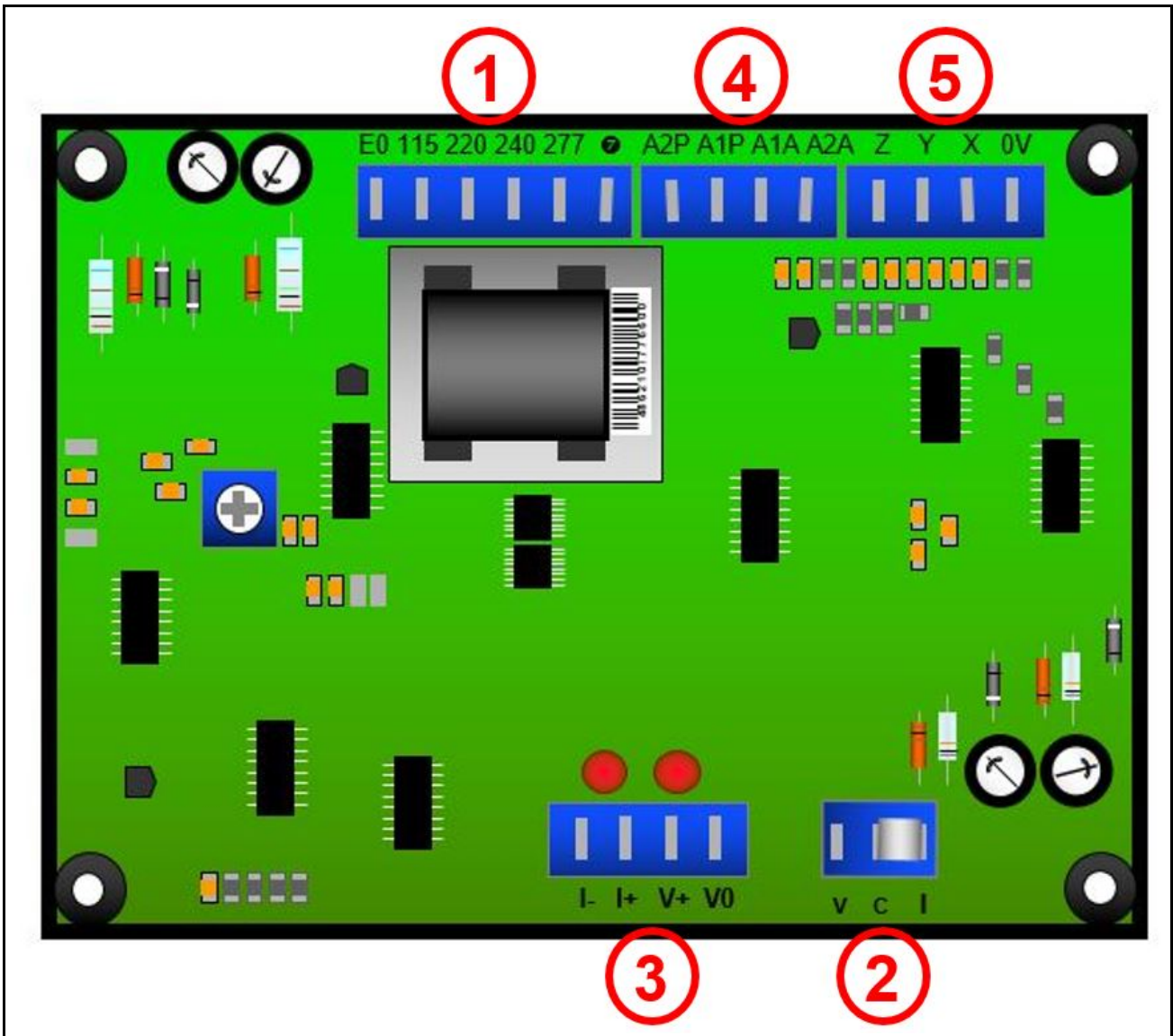

Ref.	Control	Function
1	Power Supply E0, 115 : 110 VAC to 125 VAC E0, 220 : 200 VAC to 230 VAC E0, 240 : 231 VAC to 250 VAC E0, 277 : 251 VAC to 290 VAC	Connect to VAC supply voltage
2	Link : Control Input C-I : current signal C-V : voltage signal	Select current or voltage control input
3	Control Input I-, I+ : 4 mA to 20 mA signal V0, V+ : 0 VDC to 10 VDC signal	Connect to current or voltage control input
4	Control Output : Voltage A1A, A2A : connect to A1, A2 at AVR A1P, A2P : connect to A1, A2 at PFC3	Connect to AVR and/or PFC3
5	Control Output : Power Factor 0V, X, Y, Z : connect to 0V, RX, RY, RZ at PFC3	Connect to PFC3

FIGURE 12. REMOTE CONTROL INTERFACE CONTROLS

4.7 Hand Trimmer (for remote voltage adjustment)

A hand trimmer can be fitted in a convenient position (typically in the generator set control panel) and connected to the AVR to provide fine adjustment of the alternator voltage. The hand trimmer value and the adjustment range obtained is as defined in the Technical Specification. Refer to wiring diagram before removing the shorting link and connecting the hand trimmer.

4.8 Droop Transformer (for parallel operation – alternator to alternator)

A droop transformer can be fitted in a defined position in the alternator main output wiring and connected to the AVR to enable parallel operation with other alternators. The adjustment range is as defined in the AVR manual. Refer to wiring diagram before removing the shorting link and connecting the droop transformer. The droop transformer MUST be connected in the correct main output terminal for proper operation (details are as shown in the machine wiring diagram).

4.9 Power Factor Controller (PFC) (for parallel operation – alternator to mains utility)

An electronic control module is available for use with the AVR to provide power factor control of the alternator output. The module uses alternator voltage and output current as inputs and interfaces with the AVR to ensure the necessary flexibility of the alternator excitation and hence control of the exported (or imported) kVAr. This allows full closed-loop control of the alternator power factor at the point of connection into the mains utility. Other features allow the alternator (or alternators) to be automatically 'voltage-matched' prior to paralleling.

NEWAGE® | STAMFORD® | AvK®

Powering the world with confidence since 1904



Copyright 2020, Cummins Generator Technologies Ltd. All rights reserved.

Cummins and the Cummins logo are registered trademarks of Cummins Inc.

NEWAGE, STAMFORD and AvK are registered trademarks of Cummins Generator Technologies Ltd.