

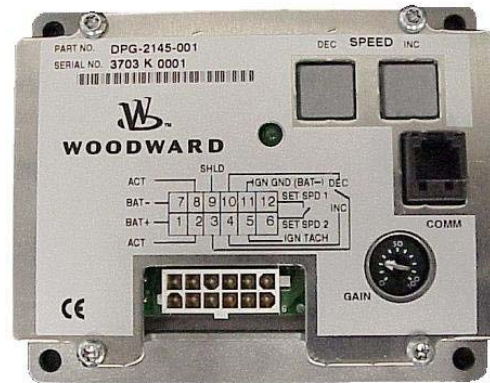

DPG-2101-001



DPG-2145-001

DPG-21XX-00X Digital Controllers

**Programmable Controllers for
Isochronous Generators**

IMPORTANT



This is the safety alert symbol. It is used to alert you to potential personal injury hazards. Obey all safety messages that follow this symbol to avoid possible injury or death.

DEFINITIONS

- **DANGER**—Indicates a hazardous situation which, if not avoided, will result in death or serious injury.
- **WARNING**—Indicates a hazardous situation which, if not avoided, could result in death or serious injury.
- **CAUTION**—Indicates a hazardous situation which, if not avoided, could result in minor or moderate injury.
- **NOTICE**—Indicates a hazard that could result in property damage only (including damage to the control).
- **IMPORTANT**—Designates an operating tip or maintenance suggestion.

WARNING

The engine, turbine, or other type of prime mover should be equipped with an overspeed shutdown device to protect against runaway or damage to the prime mover with possible personal injury, loss of life, or property damage.

The overspeed shutdown device must be totally independent of the prime mover control system. An overtemperature or overpressure shutdown device may also be needed for safety, as appropriate.



Read this entire manual and all other publications pertaining to the work to be performed before installing, operating, or servicing this equipment. Practice all plant and safety instructions and precautions. Failure to follow instructions can cause personal injury and/or property damage.



This publication may have been revised or updated since this copy was produced. To verify that you have the latest revision, be sure to check the Woodward website:

www.woodward.com/pubs/current.pdf

The revision level is shown at the bottom of the front cover after the publication number. The latest version of most publications is available at:

www.woodward.com/publications

If your publication is not there, please contact your customer service representative to get the latest copy.



Any unauthorized modifications to or use of this equipment outside its specified mechanical, electrical, or other operating limits may cause personal injury and/or property damage, including damage to the equipment. Any such unauthorized modifications: (i) constitute "misuse" and/or "negligence" within the meaning of the product warranty thereby excluding warranty coverage for any resulting damage, and (ii) invalidate product certifications or listings.

NOTICE

To prevent damage to a control system that uses an alternator or battery-charging device, make sure the charging device is turned off before disconnecting the battery from the system.

NOTICE

To prevent damage to electronic components caused by improper handling, read and observe the precautions in Woodward manual 82715, *Guide for Handling and Protection of Electronic Controls, Printed Circuit Boards, and Modules*.

Revisions—Text changes are indicated by a black line alongside the text.

Woodward Governor Company reserves the right to update any portion of this publication at any time. Information provided by Woodward Governor Company is believed to be correct and reliable. However, no responsibility is assumed by Woodward Governor Company unless otherwise expressly undertaken.

© Woodward 2010
All Rights Reserved

Contents

REGULATORY COMPLIANCE	III
Declaration of Conformity	iii
ELECTROSTATIC DISCHARGE AWARENESS	VI
CHAPTER 1. GENERAL INFORMATION.....	1
Introduction	1
CHAPTER 2 CONTROLLER SPECIFICATIONS	2
Configurations	2
User Interface Operation	4
CHAPTER 3 PARAMETER REFERENCE.....	5
Parameter List	6
3.1 No. of Flywheel Teeth or Pulses Per Revolution (optional)	8
3.2 Set Speed A (required)	9
3.3 Set Speed B (optional)	9
3.4 Idle Speed (optional).....	9
3.5 Proportional (required).....	10
3.6 Integral (required)	10
3.7 Derivative (required)	11
3.8 OVG @ Set Speed A (required)	11
3.9 OVG @ Set Speed B (optional).....	11
3.10 OVG @ Idle Speed (optional).....	11
3.11 Gain Factor (required)	11
3.12 Speed Filter (required).....	12
3.13 Idle Hold Time (optional)	12
3.14 Accel Rate (optional)	13
3.15 Decel Rate (optional).....	13
3.16 Startup Rate (optional)	13
3.17 Integral Low Limit (optional)	14
3.18 Integral High Limit (optional).....	14
3.19 Password	15
3.20 Over Speed Limit (optional).....	15
3.21 Set Speed A Min (optional).....	16
3.22 Set Speed A Max (optional).....	16
3.23 Set Speed B Min (optional).....	16
3.24 Set Speed B Max (optional).....	16
3.25 Idle Speed Min (optional).....	16
3.26 Idle Speed Max (optional).....	16
3.27 Duty Cycle Limit (optional).....	16
3.28 Startup Speed (required)	17
3.29 Startup Duty Cycle (optional).....	18
CHAPTER 4. UNIVERSAL PST	19
Introduction	19
Features.....	19
System Requirements	19
Acquiring Universal PST.....	20
Installing Universal PST	21
Wiring the COMM Port to a PC	21
Communications Error	22
Universal PST User Interface Overview	22
Universal PST Menu Items.....	24
Parameter Setup.....	24
Parameter Help.....	25
Synchronizing Universal PST with a DPG.....	25
Status View	25

Contents (cont'd)

Tuning View	26
Chart Recorder	26
Engine Speed Data Collection	27
CHAPTER 5. CALIBRATION INSTRUCTIONS	28
Basic Adjustments	28
Tuning Methodology	28
Startup Sequence	30
CHAPTER 6. INSTALLATION INSTRUCTIONS	31
Recommended Mounting	31
Terminal Descriptions	31
Wiring Diagrams	33
DPG-2101-00X	33
DPG-2145-00X	34
DPG-2146-00X	35
DPG-2155-00X	36
Centralized Suppression	37
CHAPTER 7. DIAGNOSTICS & TROUBLESHOOTING	39
LED Indications	39
Troubleshooting Table	39
CHAPTER 8. SERVICE OPTIONS	41
Product Service Options	41
Woodward Factory Servicing Options	42
Returning Equipment for Repair	42
Packing a Control	43
Replacement Parts	43
Engineering Services	43
How to Contact Woodward	44
Technical Assistance	44

Illustrations

Figure 1. Wiring Diagram for DPG-2101-001 and DPG-2101-002 Controllers	33
Figure 2. Wiring Diagram for DPG-2145-001 and DPG 2145-002 Controllers	34
Figure 3. Wiring Diagram for DPG-2146-001 and DPG-2146-002 Controllers	35
Figure 4. Wiring Diagram for DPG-2155-001 and DPG-2155-002 Controllers	36
Figure 5. Centralized Suppression Implemented at the System Level	38

Regulatory Compliance

Declaration of Conformity DPG-2145 & DPG 2155

DECLARATION OF CONFORMITY

Manufacturer's Name: WOODWARD GOVERNOR COMPANY (WGC)

Manufacturer's Address: 1000 E. Drake Rd.
Fort Collins, CO, USA, 80525

Model Name(s)/Number(s): DPG-2145 & DPG-2155 Series

Conformance to Directive(s): 2004/108/EC COUNCIL DIRECTIVE of 15 December 2004 on the approximation of the laws of the Member States relating to electromagnetic compatibility and all applicable amendments.

Applicable Standards: EN61000-6-4, (2007): EMC Part 6-4: Generic Standards - Emissions for Industrial Environments

EN61000-6-2, (2005): EMC Part 6-2: Generic Standards - Immunity for Industrial Environments

We, the undersigned, hereby declare that the equipment specified above conforms to the above Directive(s).

MANUFACTURER

Signature

Karen Suhre

Full Name

Engineering Manager

Position

WGC, Fort Collins, CO, USA

Place

Date

4-21-09

Declaration of Conformity DPG 2101 & DPG 2146

DECLARATION OF CONFORMITY

Manufacturer's Name: WOODWARD GOVERNOR COMPANY (WGC)

Manufacturer's Address: 1000 E. Drake Rd.
Fort Collins, CO, USA, 80525

Model Name(s)/Number(s): DPG-2133, DPG-2101, & DPG-2146 Series

Conformance to Directive(s): 2004/108/EC COUNCIL DIRECTIVE of 15 December 2004 on the approximation of the laws of the Member States relating to electromagnetic compatibility and all applicable amendments.

Applicable Standards: EN61000-6-4, (2007): EMC Part 6-4: Generic Standards - Emissions for Industrial Environments

EN61000-6-2, (2005): EMC Part 6-2: Generic Standards - Immunity for Industrial Environments

We, the undersigned, hereby declare that the equipment specified above conforms to the above Directive(s).

MANUFACTURER



Signature

Karen Suhre

Full Name

Engineering Manager

Position

WGC, Fort Collins, CO, USA

Place

4/29/01

Date

EMC Limitations

Cabling

All cabling for this unit is limited to less than 30m (98.4'). See wiring diagrams for specific cable types required.

Power cabling is limited to less than 10m (32.8') in total length from its source; power is intended to be from a local bus structure. The control is NOT intended to have a power bus that is derived from a plant-wide distribution system, remote source, or similar "mains" type distribution systems. The power to the control should also be a dedicated circuit, directly to the battery or source via a power and return wire that are routed together.

See User Manual 36526 for additional regulatory information, limitations, and wiring diagrams with specific, required cable types.

Power Bus

The power bus is intended to be a local bus without power line surges and to have inductive load kickback events suppressed. Therefore, the control's power input is not designed to withstand a charging system load dump, heavy inductive kickbacks, or heavy surge type pulses. If the control is installed outside its intended usage, as described in this manual, centralized voltage pulse suppression should be implemented to help protect the control and other components on the bus. (See Chapter 6: Installation Instructions.)

COMM Port

The COMM port is intended to be a service port, with only temporary connection during service or initial configuration. The COMM port is susceptible to some EMC phenomena and possible unintentional battery return currents.

1. Battery return (B-) is also the communication signal common; typically PCs connect the communication signal's common to protective earth. The PC grounding can provide an unintended return path for B- currents. If B- and the PC are grounded to protective earth, a communication isolator should be used between the PC and the control. Damage to the PC or control, and/or unintended operation may result from a broken battery return wire or the parallel path.
2. The pins inside the COMM port plug are susceptible to damage by ESD discharges, static electricity arcs. Care should be taken not to touch them with tools or put fingers into the port. Always touch your hand or tool to a grounded piece of metal (discharge ESD) prior to coming in contact with the communication port.
3. The input is susceptible to RF noise such as switching transients and transmitter signals coupled into the communication cable. Cable orientation and short cable length may be used to eliminate these issues, depending on the severity of the environment.

Electrostatic Discharge Awareness

All electronic equipment is static-sensitive, some components more than others. To protect these components from static damage, you must take special precautions to minimize or eliminate electrostatic discharges.

Follow these precautions when working with or near the control.

1. Before doing maintenance on the electronic control, discharge the static electricity on your body to ground by touching and holding a grounded metal object (pipes, cabinets, equipment, etc.).
2. Avoid the build-up of static electricity on your body by not wearing clothing made of synthetic materials. Wear cotton or cotton-blend materials as much as possible because these do not store static electric charges as much as synthetics.
3. Keep plastic, vinyl, and Styrofoam materials (such as plastic or Styrofoam cups, cup holders, cigarette packages, cellophane wrappers, vinyl books or folders, plastic bottles, and plastic ash trays) away from the control, the modules, and the work area as much as possible.
4. Do not remove the printed circuit board (PCB) from the control cabinet unless absolutely necessary. If you must remove the PCB from the control cabinet, follow these precautions:
 - Do not touch any part of the PCB except the edges.
 - Do not touch the electrical conductors, the connectors, or the components with conductive devices or with your hands.
 - When replacing a PCB, keep the new PCB in the plastic antistatic protective bag it comes in until you are ready to install it. Immediately after removing the old PCB from the control cabinet, place it in the antistatic protective bag.

NOTICE

To prevent damage to electronic components caused by improper handling, read and observe the precautions in Woodward manual 82715, *Guide for Handling and Protection of Electronic Controls, Printed Circuit Boards, and Modules*.

Chapter 1.

General Information

Introduction

This manual provides information on the following DPG controllers:

DPG-2101-001 and DPG-2101-002	DPG-2146-001 and DPG-2146-002
DPG-2145-001 and DPG-2145-002	DPG-2155-001 and DPG-2155-002

The DPG-21XX-00X digital controller is used primarily to govern diesel or gas fueled engines of generator sets. This microprocessor based, digital controller performs across a wide speed range and allows adjustment of set speed and gain parameters with the built-in user interface. The COMM port provides access to all other controller settings, allowing adaptation to each application during service and initial configuration.

Separately programmable Proportional, Integral, and Derivative gains are provided for tailoring controller response to many engine applications. Other adjustments include acceleration and deceleration ramp rates, idle speed set, hold time, and more.

Properly tuned, this controller delivers fast engine response to speed or load change while providing precise stable isochronous operation.

The controller's internal FAILSAFE reacts instantly to loss of the engine speed signal, allowing the actuator to return to minimum fuel.

Features include:

- Automatic calibration of the remote speed potentiometer
- Isochronous speed control
- User friendly / operator adjustable
- Precision frequency control: 0.25%
- Superior temperature stability
- Reverse battery protection
- Input voltage range: 9–30 Vdc
- Smoke control on start up
- Remote setup
- Serial communication port

Actuator Compatibility:

DYNA 2000	DYNA 70000	DYNA 8000	APECS 0150	EPG 512
DYNA 2500	DYNA 70025	DYNA 8200	APECS 0250	EPG 1724
	DYNA 10141	DYNA 8400	APECS 0300	

APECS Linkage Free Integral Type

Other Models Available:

DPG-2100 Series – for Genset Applications
 DPG-2300 Series – for Off-Road Vehicles
 DPG-2400 Series – for EFC Applications

Chapter 2

Controller Specifications

The controller's main electrical and mechanical specifications are listed below along with several performance characteristics.

Configurations

Model No.	Connector Style Options		Speed Sensing Options		Adj. Set Speeds	Remote Speed INC and DEC
	7-wire Euro	12-pin Molex	Magnetic Pickup	Ignition Sense		
DPG-2101-00X	✓		✓		1 + idle	
DPG-2145-00X		✓		✓	2 + idle	✓
DPG-2146-00X	✓			✓	1 + idle	
DPG-2155-00X		✓	✓		2 + idle	✓

Electrical

Operating Voltage Range:	9–30 Vdc *
Rated Output Current:	7 A Maximum (continuous)
Maximum Surge Current:	14 A (not to exceed ten seconds)
Connections:	Terminal strip with 7 Euro style terminals or a quick connector with 12 pins
Input Signal from Magnetic Pickup:	2.0 VAC RMS minimum during cranking
Input Signal from Engine's Ignition System:	40 V minimum during cranking

(*) All cabling for these controllers is limited to less than 30m (98.4'). Power cabling is limited to less than 10m (32.8') in total length. See wiring diagrams for specific cable types required.

Mechanical

Ambient Operating Temperature:	-40°F to +185°F (-40°C to +85°C)
Sealing:	Oil, water, and dust resistant via conformal coating and die cast enclosure
Weight:	10 oz. (284 g)

Performance

Steady State Speed Band:	± .25% over ambient operating temperature range
Engine Speed MPU Measurement Range:	10 MPU Hertz to 14,000 MPU Hertz
Governing Speed Range with MPU:	500 MPU Hertz to 11,000 MPU Hertz
Engine Speed Ignition Measurement Range:	2 Hertz to 350 Hertz
Governing Speed Range with Ignition:	25 Hertz to 300 Hertz

Suggested Mating Connectors for DPG-2145-00X and DPG-2155-00X Models

AMP 770581-1	Mini universal Mate-N-Lock
AMP 171637-3 or 794407-3	Duplex finish socket
AMP 90707-1	Crimping hand tool for 18 gauge wire
AMP 408-4137	Crimping documentation
AMP 189727-1	Socket extraction tool

User Interface Operation

Keypad

The DPG-21XX-00X provides two buttons for adjusting the engine set speed.

- INC – increases the *selected* Set Speed (A or B)
- DEC – decreases the *selected* Set Speed (A or B)

Gain Potentiometer

The DPG-21XX-00X series controllers provide a potentiometer (labeled GAIN) to adjust the OVG @ Set Speed A. This is one of the controller's tuning parameters.

The gain potentiometer's adjustment range is 1 to 99.

LED

The LED (Light Emitting Diode) is used as a status indicator. When the LED is off, it indicates that one of the following is true:

- The unit is not being powered.
- The unit is reverse powered (check polarity of supplied power).

If a voltage between 9 Vdc and 30 Vdc is being properly supplied across the BAT+ and BAT- connector pins of the controller and the LED is off, then refer to the troubleshooting chapter.

A slow blinking LED indicates all of the following:

1. The unit is powered.
2. The controller is not seeing a speed signal.

This means the engine is not running. If the engine is running or cranking and the LED is blinking slow, then refer to the troubleshooting chapter for help in diagnosing why the speed signal to the controller is missing.

A fast blinking LED indicates all of the following:

1. The unit is powered.
2. There is an engine speed signal at the controller's tachometer inputs.

When the LED is on and not blinking it indicates the following:

1. The unit is powered.
2. There is a controller fault.

NOTE: The slow blink rate = ½ Hertz (the LED is turned on for 1 second followed by off for 1 second then on again and so on). The fast blink rate is 3 times faster than the slow blink rate.

COMM Port

All adjustments may be done by having the controller connected, via the COMM port, to a computer running the Universal PST application. Remote access via the COMM port is intended for connection only while programming, tuning and troubleshooting the control. **It is a service port and not intended for permanent connection.**

The Universal PST is an MS Windows based application available from the Software Products page at www.woodward.com/IC/Software. See Chapter 4 for a description of this tool.

NOTICE

The COMM port is intended only for configuration and periodic service. Do not leave a computer and/or COMM cable connected to the COMM port.

Chapter 3

Parameter Reference

This chapter provides information regarding each of the parameters that can be adjusted when a computer is connected to the controller via the COMM port. Universal PST (described in the following chapter) is required to make adjustments to the parameters described in this chapter, with the exception of Set Speed A, Set Speed B, and OVG @ Set Speed A. It contains 29 subsections. Each subsection provides information about a single parameter.

The following tables list each of the parameters and their default, minimum, and maximum values. Several of the parameters have minimum and maximum values set by other parameters. *Speed* and *Rate* values are shown as Hertz values.

The parameter list provides information regarding each of the parameters that can be adjusted when a computer is connected to the controller via the COMM port and the Universal PST software.

NOTICE

The COMM port is intended only for configuration and periodic service. Do not leave a computer and/or COMM cable connected to the COMM port.

Parameter List

DPG-2101-00X & DPG-2146-00X

PARAMETER LIST FOR DPG-2101-00X (MPU) & DPG-2146-00X (IGNITION) (These controllers use the 7-terminal Euro style screw terminal connector.)					
	PARAMETER NAME		DEFAULT	MINIMUM	MAXIMUM
Opt.	1. No. of Flywheel Teeth or Pulses per revolution	-001	0	0	0
		-002	0	0	572
Req.	2. Set Speed A		1000 (25)	Set Speed A Min	Set Speed A Max
	3. Not Available				
Opt.	4. Idle Speed		50 (20)	Idle Speed Min	Idle Speed Max
Req.	5. Proportional		25	1	99
Req.	6. Integral		50	0	99
Req.	7. Derivative		25	0	99
Req.	8. OVG @ Set Speed A		Use the controller's built-in GAIN potentiometer		
	9. Not Available				
Opt.	10. OVG @ Idle Speed		20	1	99
Req.	11. Gain Factor		20 (40)	1	99
Req.	12. Speed Filter		16 (4)	1	24
Opt.	13. Idle Hold Time		0	0	9999
Opt.	14. Accel Rate		1000 (3000)	1	9999
Opt.	15. Decel Rate		1000 (3000)	1	9999
Opt.	16. Startup Rate		1000 (3000)	1	9999
Opt.	17. Integral Low Limit		0	0	Integral High Limit
Opt.	18. Integral High Limit		99	Integral Low Limit	99
N/A.	19. Password		Not Available		
Opt.	20. Over Speed Limit	-001	100	0	100
		-002	15000 (450)	0	15000 (450)
Opt.	21. Set Speed A Min		10 (2)	10 (2)	Set Speed A
Opt.	22. Set Speed A Max		11000 (300)	Set Speed A	11000 (300)
	23. Not Available				
	24. Not Available				
Opt.	25. Idle Speed Min		10 (2)	10 (2)	Idle Speed
Opt.	26. Idle Speed Max		11000 (300)	Idle Speed	11000 (300)
Opt.	27. Duty Cycle Limit		95	10	95
Req.	28. Startup Speed		1000 (25)	10 (2)	11000 (300)
Opt.	29. Startup Duty Cycle		30	5	95

Req. = Parameter adjustment is required to achieve basic governing.
Opt. = Parameter use is optional. NA = Parameter is not available.

Default, Minimum and Maximum values in parenthesis apply when the controller uses ignition pulses to sense engine speed, which would be the case for a DPG-2146-00X controller

NOTICE

All Speed and Rate values are shown as Hertz values (parameters 2, 4, 14-16, 20-22, 25-26). Changing the value of parameter 1 will cause different default values to be displayed based on the Hertz to RPM formula. These parameters can be changed with PST max by 100 (MPU input) or 10 (IGNITION input) at once when engine is running.

Parameter List

DPG-2155-00X & DPG-2145-00X

PARAMETER LIST FOR DPG-2155-00X (MPU) & DPG-2145-00X (IGNITION) (These controllers use the 12-terminal quick connect.)					
	PARAMETER NAME		DEFAULT	MINIMUM	MAXIMUM
Opt.	1. No. of Flywheel Teeth or Pulses per Revolution	-001	0	0	0
		-002	0	0	572
Req.	2. Set Speed A		1000 (25)	Set Speed A Min	Set Speed A Max
Opt.	3. Set Speed B		1000 (25)	Set Speed B Min	Set Speed B Max
Opt.	4. Idle Speed		50 (20)	Idle Speed Min	Idle Speed Max
Req.	5. Proportional		25	1	99
Req.	6. Integral		50	0	99
Req.	7. Derivative		25	0	99
Req.	8. OVG @ Set Speed A		Use the controller's built-in GAIN potentiometer		
Opt.	9. OVG @ Set Speed B		20	1	99
Opt.	10. OVG @ Idle Speed		20	1	99
Req.	11. Gain Factor		20 (40)	1	99
Req.	12. Speed Filter		16 (4)	1	24
Opt.	13. Idle Hold Time		0	0	9999
Opt.	14. Accel Rate		1000 (3000)	1	9999
Opt.	15. Decel Rate		1000 (3000)	1	9999
Opt.	16. Startup Rate		1000 (3000)	1	9999
Opt.	17. Integral Low Limit		0	0	Integral High Limit
Opt.	18. Integral High Limit		99	Integral Low Limit	99
N/A.	19. Password		Not Available		
Opt.	20. Over Speed Limit	-001	100	0	100
		-002	15000 (450)	0	15000 (450)
Opt.	21. Set Speed A Min		10 (2)	10 (2)	Set Speed A
Opt.	22. Set Speed A Max		11000 (300)	Set Speed A	11000 (300)
Opt.	23. Set Speed B Min		10 (2)	10 (2)	Set Speed A
Opt.	24. Set Speed B Max		11000 (300)	Set Speed B	11000 (300)
Opt.	25. Idle Speed Min		10 (2)	10 (2)	Idle Speed
Opt.	26. Idle Speed Max		11000 (300)	Idle Speed	11000 (300)
Opt.	27. Duty Cycle Limit		95	10	95
Req.	28. Startup Speed		1000 (25)	10 (2)	11000 (300)
Opt.	29. Startup Duty Cycle		30	5	95

Req. = Parameter adjustment is required to achieve basic governing.
Opt. = Parameter use is optional. NA = Parameter is not available.

Default, Minimum and Maximum values in parenthesis apply when the controller uses ignition pulses to sense engine speed, which would be the case for a DPG-2145-00X controller.

NOTICE

All Speed and Rate values are shown as Hertz values (parameters 2-4, 14-16, 20-26). Changing the value of parameter 1 will cause different default values to be displayed based on the Hertz to RPM formula. These parameters can be changed with PST max by 100 (MPU input) or 10 (IGNITION input) at once when engine is running.

3.1 No. of Flywheel Teeth or Pulses Per Revolution (optional)

This parameter provides the conversion factor needed to display speeds as RPM values instead of Hertz values. Adjusting this parameter is optional. The default value of 0 disables Hertz (Hz) to RPM conversions so all set speeds are displayed in Hertz. Setting this parameter to a value other than zero enables Hertz to RPM conversion.

IMPORTANT

DPG-21XX- 002 Models—Adjusting the No. of Flywheel Teeth parameter is prohibited while the engine is running.

Adjust this parameter to a value equal to the exact number of pulses seen by the controller in one revolution of the engine to display set speeds in RPM. The formula used to convert the speed signal from a Hertz value to a RPM value is:

$$\frac{[(\text{Hertz}) \times (60s)]}{[\text{Pulses_per_rev}]} = [\text{EngineRPM}]$$

For example:

$$\frac{[(3960\text{Hz}) \times (60s)]}{[132\text{Pulses_per_rev}]} = [1800\text{RPM}]$$

The following derivation of the above formula can be used to convert from RPM to Hertz.

$$\frac{[(\text{EngineRPM}) \times (\text{Pulses_per_rev})]}{[60's]} = [\text{Hertz}]$$

DPG-2101-00X and DPG-2155-00X Models

To use this parameter correctly on controllers sensing engine speed with a magnetic pickup, you must know the exact number of flywheel teeth that pass by the magnetic pickup in one revolution of the engine.

DPG-2145-00X and DPG-2146-00X Models

To use this parameter correctly on controllers sensing engine speed via ignition pulses, you must know the exact number of ignition pulses that occur in one revolution of the engine.

IMPORTANT

When the No. of Flywheel Teeth parameter is used, the SET SPEED A, SET SPEED B, IDLE SPEED, OVER SPEED LIMIT, SET SPEED A MIN, SET SPEED A MAX, SET SPEED B MIN, SET SPEED B MAX, IDLE SPEED MIN, IDLE SPEED MAX and STARTUP SPEED parameters are displayed as RPM values instead of Hertz values.

3.2 Set Speed A (required)

This parameter is adjustable both from the controller's DEC and INC keys and by using the Universal PST application. However, when the value is changed using the controller's keypad, the value displayed by the Universal PST does not automatically update. To refresh the value displayed on the PC the user must select a different parameter with the mouse pointer then reselect the value of Set Speed A. The Universal PST application also provides a [Read All] button that can be used to perform a complete refresh of all parameter values.

SET SPEED A is the controller's target speed after startup when Set Speed B is not selected. The startup sequence is complete when the target speed and the engine speed reach the set speed.

**The default value for SET SPEED A is 1000 MPU Hertz (25 Hertz ignition).
The SET SPEED A parameter's adjustable range extends from SET SPEED A MIN to SET SPEED A MAX.**

DPG-2145-00X and DPG-2155-00X Models

When a two-position switch is connected between SET SPD 1 (pin 12) and SET SPD 2 (pin 6) then an open switch selects SET SPEED A as the controller's target speed. If the controller's SET SPD inputs are not used then SET SPEED A is automatically the active target speed after the startup sequence is completed.

See the Installation Instructions chapter for details about using the speed select feature.

3.3 Set Speed B (optional)

DPG-2145-00X and DPG-2155-00X Models

SET SPEED B becomes the controller's target speed when SET SPD 1 (pin 12) and SET SPD 2 (pin 6) of the connector are tied together. In other words, when a two-position switch is connected between SET SPD 1 (pin 12) and SET SPD 2 (pin 6) then a closed switch selects SET SPEED B as the controller's target speed.

**The default value for SET SPEED B is 1000 MPU Hertz (25 Hertz ignition).
The SET SPEED B parameter's adjustable range extends from SET SPEED B MIN to SET SPEED B MAX.**

See the Installation Instructions chapter for details about using the speed select feature.

3.4 Idle Speed (optional)

DPG-2101-00X and DPG-2146-00X Models

The IDLE SPEED is the controller's target speed for the IDLE HOLD TIME when the engine is started. When the idle hold timer reaches zero, the target speed will become SET SPEED A.

DPG-2145-00X and DPG-2155-00X Models

The IDLE SPEED is the controller's target speed for the IDLE HOLD TIME when the engine is started. When the idle hold timer reaches zero, the target speed will be either SET SPEED A or SET SPEED B depending on the state of the SPEED SEL input terminal.

The default value for IDLE SPEED is 500 MPU Hertz (20 Hertz ignition). The IDLE SPEED parameter's adjustable range extends from IDLE SPEED MIN to IDLE SPEED MAX.

3.5 Proportional (required)

The proportional term is one of the interrelated PID terms that determine how well a DPG controller governs the engine's speed. A speed change creates a speed error (the difference between the target speed and the actual speed.) The proportional gain controls the size of the controller output response to a step change in the speed error.

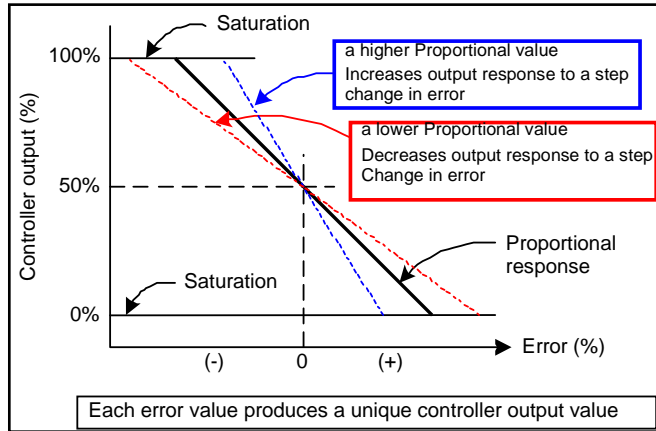

3.6 Integral (required)

The integral term is one of the interrelated PID terms that determine how well a DPG controller governs the engine's speed. The integral term acts to drive speed error to zero. In a proportional only control with constant load, there will be a constant speed error that inversely relates to the proportional gain of the system. The integral term is key to isochronous speed control. This term eliminates the difference between the programmed set speed and the actual speed. The integral gain changes the time it takes to drive the error to zero.

Note: Integral is needed to eliminate speed offsets due to proportional gain and should never be left at zero.

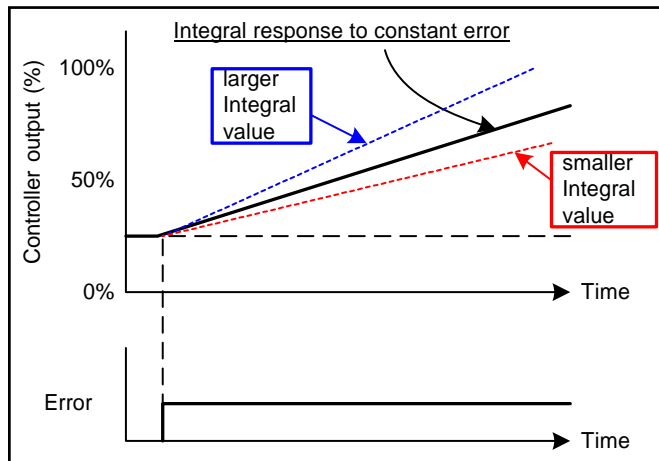

3.7 Derivative (required)

The derivative term is one of the interrelated PID terms that determine how well a DPG controller governs the engine's speed. The derivative responds to the rate of change in the speed error. This parameter is primarily used to dampen very rapid oscillations resulting from large speed changes. The derivative responds to engine acceleration or deceleration. If the engine speed approaches the target speed at a fast rate, the derivative acts to minimize or eliminate overshoot. A zero value is allowed but systems typically require some derivative gain to improve overall engine speed control.

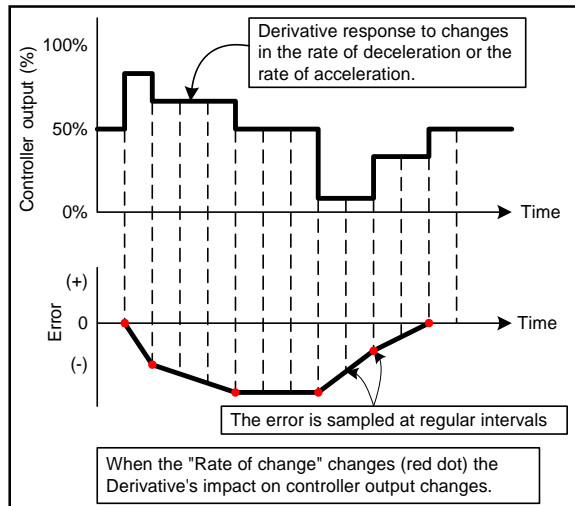

3.8 OVG @ Set Speed A (required)

This overall gain acts as the multiplier on the three PID terms (proportional, integral, derivative) when Set Speed A is selected as the active target speed. The controller's built-in gain potentiometer is adjustable from 1 to 99.

3.9 OVG @ Set Speed B (optional)

DPG-2145-00X and DPG-2155-00X Models

This overall gain acts as the multiplier on the three PID terms (proportional, integral, derivative) when Set Speed B is selected as the active target speed. This overall gain term is adjustable from 01 to 99.

3.10 OVG @ Idle Speed (optional)

This overall gain acts as the multiplier on the three PID terms (proportional, integral, derivative) when the Idle Speed is the active target speed. The idle speed set point is active only during startup when the idle hold timer is running. This overall gain term is adjustable from 01 to 99.

3.11 Gain Factor (required)

The gain factor parameter is used to obtain more range of adjustment from the PID terms. In other words, if any of the PID terms or the overall gain terms reach

their adjustment limits then this value can be modified to provide for more range of adjustment in the PID and OVG terms.

For example, if the PID terms are set to 90, 80, and 50 respectively and the Gain Factor is set to 20, then doubling the Gain Factor by setting it to 40 allows the PID terms to be halved to 45, 40, and 25 respectively. These new settings are equivalent to the previous settings with respect to the controller's tuning response and now allow the PID terms to be adjusted higher if needed.

3.12 Speed Filter (required)

This parameter indicates the number of flywheel teeth to use when computing an average engine speed and is used to dampen out speed measurement variations that can make PID tuning difficult. But, keep in mind the following.

- Too much filtering will slow down the controller's response to speed changes.
- Too little filtering can make the controller overly sensitive and tuning difficult.

There is measurable acceleration and deceleration that occurs between cylinder firings. As a general rule, less filtering is required the more engine cylinders there are. This is because the number of acceleration-deceleration cycles increases and these oscillations will have lower amplitude. With more cylinders, there is less time for the speed to slow down before the next cylinder firing.

Rotational mass also affects the amount of speed signal filtering needed. The more rotational mass, the less filtering is needed. The less rotational mass, the more filtering is needed.

For installations using a magnetic pickup to sense engine speed

Typically, the value 24 works well on small 3- or 4-cylinder engines. A value of 16 is recommended for 6- or 8-cylinder engines. The following formula can also be used to derive a good starting point for the speed filter value for a given engine application. Round the result to the nearest integer. The maximum value allowed is 24.

$$[(\text{No. of flywheel teeth}) / (\text{No. of engine cylinders})] * 0.75 = \text{speed_filter_value}$$

For installations using ignition pulses to sense engine speed

It is recommended that the Speed Filter be at least equal to the number of ignition pulses per one revolution of the engine. A good starting point would be 2 times the number of ignition pulses per one revolution of the engine.

$$[(\text{pulses_per_rev}) * (2)] = \text{speed_filter_value}$$

3.13 Idle Hold Time (optional)

The idle hold time specifies how long, after starting, the engine is to stay at the idle speed before finishing the ramp to the target speed. The time value has a resolution of one-tenth of a second.

During the startup sequence, the controller increases the engine speed from the engine's crank speed to the active target speed at the STARTUP RATE specified. If the IDLE HOLD TIME is nonzero, the initial target speed will be the IDLE SPEED. After the IDLE HOLD TIME expires, the controller then uses the ACCEL RATE to ramp the engine to the selected set speed (REMOTE SPEED POT or SET SPEED A). The startup sequence is complete once the engine speed reaches the selected set speed.

3.14 Accel Rate (optional)

This rate specifies how fast the controller should increase the engine's speed when a new, higher target speed is made active. The unit in which the parameter value is specified depends on the type of speed sensor used by the controller and on the value of Parameter 3.1 (Number of Teeth or Pulses per Revolution, as shown in the table below).

SPEED SENSOR	PARAMETER 3.1 = 0	PARAMETER 3.1 > 0
MPU	Hz/s	rpm/s
Ignition	Hz/10s	rpm/s

Below is the formula for calculating accel rate value for a desired ramp time. When using controller with ignition speed sensor in Hz mode the resulting value must be multiplied by 10.

$$[(\text{higher_speed} - \text{lower_speed}) / (\text{ramp_time_in_seconds}) = \text{accel_rate_value}]$$

For example, suppose Set Speed A is 3300 Hertz and Set Speed B is at 3960 Hertz. The controller is currently controlling the engine at 3300 Hertz (Set Speed A), when Set Speed B becomes the active target speed. It is desired that the new speed of 3960 be reached in precisely 2 seconds. The following formula determines the value needed by Accel Rate to increase the engine speed from Set Speed A to Set Speed B in 2 seconds.

$$[(\text{Set Speed B}) - (\text{Set Speed A})] / (\text{N seconds}) = \text{accel_rate_value in Hertz per second}$$

$$[3960 - 3300] / 2 = 330 \text{ Hertz per second}$$

3.15 Decel Rate (optional)

The Decel Rate specifies how fast the controller should decrease the engine's speed when a new lower target speed is made active. The unit that parameter value is specified in and the formula for calculating decel rate value is the same as for accel rate parameter (see Parameter 3.14).

For example, suppose Set Speed A is 4170 Hertz and Set Speed B is 3475 Hertz. The controller is currently controlling the engine at 4170 Hertz (Set Speed A), when Set Speed B becomes the active target speed. It is desired that the new speed of 3475 be reached in precisely 1.5 seconds. The following formula determines the value needed by Decel Rate to decrease the engine speed from Set Speed A to Set Speed B in 1.5 seconds.

$$[(\text{Set Speed A}) - (\text{Set Speed B})] / (\text{N seconds}) = \text{decel_rate_value in Hertz per second}$$

$$[4170 - 3475] / 1.5 = 463 \text{ Hertz per second}$$

3.16 Startup Rate (optional)

This parameter is used to achieve a smooth controlled engine start. On diesel engines, this feature is also useful for minimizing exhaust smoke at startup. When used in combination with the Idle Speed and Idle Hold Time, a brief warm-up cycle can be programmed.

The startup rate specifies how fast the controller should increase the engine speed when the engine is started. The unit that parameter value is specified in is the same as for accel rate parameter (see Parameter 3.14). The formula to use for determining a precise Startup Rate is shown below.

$$\text{startup_rate_value} = \frac{[(\text{final_target_speed}) - (\text{crank_speed})]}{(\text{ramp_time_in_seconds})}$$

The ramp up will pause at the STARTUP SPEED until the controller senses an MPU signal greater than the STARTUP SPEED. This prevents the startup ramp from reaching completion before the engine has even started. The controller considers MPU frequencies below the STARTUP SPEED as indicating that the engine is cranking but has not yet started. MPU frequencies above the STARTUP SPEED are taken to indicate that the engine has started and the controller will increase the engine speed until th

Exception: In cases where the target speed is less the STARTUP e selected set speed is reached.

SPEED, the startup ramp sequence ends when the target speed is reached.

IMPORTANT

When the NO. of FLYWHEEL TEETH parameter is used, the ACCEL RATE, DECEL RATE, and STARTUP RATE parameters are displayed as a RPM quantity per second instead of Hz/sec values (or 0.1Hz/sec).

3.17 Integral Low Limit (optional)

The integral low limit prevents "integral windup" in the negative direction. In other words, the integral low limit parameter is used to reduce under speed duration after a long or sustained over speed condition was present. The low limit helps reduce the duration and amount of engine under speed by maintaining a minimum actuator position.

When smaller pulse width modulated (PWM) duty cycle values do not reduce the engine speed any further but an off speed (measured speed greater than the target speed) remains, letting the Integral term grow more negative is not beneficial. Unused negative integration would cause a slower recovery from an under speed condition.

The integral low limit specifies the PWM duty cycle where the integrator's influence on lowering PID output must stop. The default value is 0%. The value can be adjusted from 0% to 90% in 1% increments.

NOTICE

Use carefully, as improper use can prevent the controller from ever reaching the target speed. The first line of defense in reducing over speed or under speed errors is a well-tuned controller via the PID terms.

3.18 Integral High Limit (optional)

The integral high limit prevents "integral windup" in the positive direction. In other words, the integral high limit parameter is used to reduce overspeed duration after a long or sustained under speed condition was present. The high limit helps reduce the duration and amount of engine overspeed by maintaining a maximum actuator position.

When larger PWM duty cycle values do not increase the engine speed any further but a negative off speed (measured speed less than the target speed)

remains, letting the Integral term grow more positive is not beneficial. Unused positive integration would cause a slower recovery from an over speed condition.

If an engine overload situation causes the engine speed to remain below the target speed for some period of time, then the integral portion of PID output would grow larger than otherwise needed (would windup). Therefore, when the load is removed the engine may over speed because it takes time for the integral portion of PID output to shrink or “unwind”. This is where reducing the Integral Limit High value can help by preventing excessive windup in the PID output’s integration term.

The integral high limit specifies the PWM duty cycle where the integrator’s influence on raising PID output must stop. The default value is 99%. The value can be adjusted from 99% down to 10% in 1% increments.

NOTICE	Use carefully, as improper use can prevent the controller from ever reaching the target speed. The first line of defense in reducing over speed or under speed errors is a well-tuned controller via the PID terms.
---------------	--

3.19 Password

The Password parameter is not available on DPG-21XX-00X Series models.

3.20 Over Speed Limit (optional)

DPG-21XX-001 Models:

This parameter is used to determine the engine speed that will trigger the controller to output minimum fuel. The parameter’s value is in terms of a percentage over the highest set speed. In other words, an over speed condition is detected if the engine speed reaches a speed of [OVER SPEED LIMIT %] greater than the highest set speed.

For example: If the highest set speed is 1800 RPM and this parameter is set to 20, then an over speed condition will be detected at 2160 RPM (the value that is 20% greater than 1800). Formula: $1.20 * 1800 \text{ RPM} = 2160 \text{ RPM}$

The default value of 100 is used to disable over speed detection. Use values less than 100 to enable the over speed limit function and set the limit speed to $[(1 + (\text{over_speed_limit_value}/100)) * (\text{highest_set_speed})]$.

DPG-21XX-002 Models:

This parameter is used to determine the engine speed that will trigger the controller to output minimum fuel. The parameter’s value is set as a frequency in Hertz or as a RPM value depending on whether the No. of Flywheel Teeth parameter is zero or nonzero respectively. The default value of 15,000 Hertz (450 Hertz ignition) is used to disable over speed detection.

The controller detects an over speed condition when it measures an engine speed that exceeds the OVER SPEED LIMIT value. When an over speed is detected the controller’s actuator output signal is set to minimum.

NOTICE	The controller must be turned off to clear the over speed detection before the engine can be restarted.
---------------	--

3.21 Set Speed A Min (optional)

Set Speed A Min is used to set the lowest value allowed for Set Speed A adjustments. The adjustable range for Set Speed A Min extends from 10 Hertz (2 Hertz ignition) to the current value of Set Speed A.

3.22 Set Speed A Max (optional)

Set Speed A Max is used to set the highest value allowed for Set Speed A adjustments. The adjustable range for Set Speed A Max extends from the current value of Set Speed A to 11000 Hertz (300 Hertz ignition).

3.23 Set Speed B Min (optional)

DPG-2145-00X and DPG 2155-00X Models

Set Speed B Min is used to set the lowest value allowed for Set Speed B adjustments. The adjustable range for Set Speed B Min extends from 10 Hertz (2 Hertz ignition) to the current value of Set Speed B.

3.24 Set Speed B Max (optional)

DPG-2145-00X and DPG 2155-00X Models

Set Speed B Max is used to set the highest value allowed for Set Speed B adjustments. The adjustable range for Set Speed B Max extends from the current value of Set Speed B to 11000 Hertz (300Hertz ignition).

3.25 Idle Speed Min (optional)

Idle Speed Min is used to set the lowest value allowed for Idle Speed adjustments. The adjustable range for Idle Speed Min extends from 10 Hertz (2 Hertz ignition) to the current value of Idle Speed.

3.26 Idle Speed Max (optional)

Idle Speed Max is used to set the highest value allowed for Idle Speed adjustments. The adjustable range for Idle Speed Max extends from the current value of Idle Speed to 11000 Hertz (300Hertz ignition).

3.27 Duty Cycle Limit (optional)

The Duty Cycle Limit parameter sets the absolute maximum amount of drive signal that can be output to the actuator and thus serves as a mechanism for fuel limiting. Fuel limiting is achieved by setting the maximum duty cycle or on-time allowed during one cycle of the PWM (pulse-width-modulation) signal controlling the actuator drive circuit. The value assigned to the duty cycle limit parameter is a percentage, and is limited to values in the range 10% to 95%. The default value is 95%.

NOTICE

When changing Duty Cycle Limit parameter, it is recommended that you update Integral High Limit parameter as well (to a value less than or equal to Duty Cycle Limit value).

3.28 Startup Speed (required)

The Startup Speed parameter should be set to an engine speed at least 10% higher than the fastest engine cranking speed but lower than the engine's idle speed. This allows the controller to determine whether the engine is cranking or running whenever an engine speed signal is present. See the "Startup Sequence" example in Chapter 5.

If the Startup Speed value is set too low (less than crank speed) the controller's target speed will be ramped to the active set speed (Idle, Set Speed A, or Set Speed B) before the engine has started. Therefore, when the engine does start, it may overspeed or output excessive smoke because the startup ramp, having already completed, no longer controls the rate of engine speed increase.

If the Startup Speed value is set too high (above the active set speed) then the Startup Speed becomes the target speed that the controller must reach before the it considers the startup sequence complete. Typically, the startup sequence ends when the engine speed reaches the active set speed. The active set speed is the Idle Speed if the Idle Hold Time parameter is a nonzero value or the "selected set speed" (either Set Speed A or Set Speed B).

To determine the proper value for this parameter the crank speed must be known. There are two ways to determine the engine crank speed.

- 1) Use a meter to measure the frequency across the MPU+ and MPU- terminals of the controller during cranking or . . .
- 2) Use a PC running the Universal PST application and read the value of the Measured Speed in the View Status panel when the engine is cranking. Note: From the Universal PST startup screen press the View Status button, then press the Start Monitoring button to begin reading values.

3.29 Startup Duty Cycle (optional)

The Startup Duty Cycle parameter is used to pre-load the PID output with a PWM duty cycle value close to that needed for the actuator to allow enough fuel to idle the engine.

If the value is too low, then the engine crank time may be longer than desired because the controller's actuator output starts from a value much smaller than needed to begin opening the fuel valve.

If the value is too high, then the engine may overspeed because the actuator opens more than needed to start the engine.

There are two ways to determine a good value to use for this parameter.

- 1) Use a meter to measure the duty cycle across the ACT terminals of the controller while the engine is running. Note: To determine if your meter is reading the correct value:
 - a. First, apply power to the controller but do NOT start the engine
 - b. Second, measure the duty cycle across the ACT terminals (No. 3 and No. 4). The reading should be 5 for 5%. If the reading is 95, then reverse the leads.
- 2) Use a PC running the Universal PST application and read the value of the PWM command in the View Status panel when the engine is cranking. Note: from the Universal PST startup screen press the View Status button, then press the Start Monitoring button to begin reading values.

Chapter 4.

Universal PST

Introduction

The Universal Parameter Setup Tool (Universal PST) is a Microsoft® Windows® application available from Woodward that enables you to adjust controller parameter settings and monitor controller operation. Universal PST also includes a graphical chart recorder that displays engine speed in real-time. This provides a visual representation of how the engine speed changes in response to changes in load, which can be very helpful when tuning the controller.

This chapter provides the information needed to use a computer with your controller. Here you will find instructions for acquiring, installing, and running the Universal PST on your PC. Also described is information for obtaining or constructing the communications cable needed to connect the controller's COMM port to your computer's serial port during service and initial programming.

Features

Universal PST features include:

- Automatic configuration to each DPG when communications are established
- Read/write access to all DPG programmable parameters and features
- View each parameter's default, minimum, and maximum values
- Diagnostics utilizing automatic refresh of DPG status
- Save and open DPG setup data information to and from a file for reuse
- Single button read to get the current values of all parameters
- Single button write to program a DPG with previously saved setup values
- Engine speed monitoring via a chart recorder to aid in tuning the controller
- Saving chart recorder data to a Microsoft Excel compatible file
- Help information on each of the controller's parameters
- Help information on using the Universal PST

System Requirements

Universal PST minimum system requirements:

- Pentium® 133 MHz PC
- 50 MB of hard disk space
- 64 MB of RAM
- Display resolution set to SVGA (800x600) or higher
- Windows® 98se, NT 4.0, 2000, and XP or greater
- Windows® 95 or ME not supported



WARNING

An unsafe condition could occur with improper use of these software tools. Only trained personnel should have access to these tools.

Acquiring Universal PST

The Universal PST software can be downloaded from the Woodward website. If you also require connection hardware you may purchase a calibration kit from Woodward. Both download and kit request instructions are described below.

Obtaining the DPG Software Calibration Kit:

The DPG Software Calibration Kit (Woodward P/N 8447-1003) contains a DB-9 modular adapter and modular cable, as well as the web address from which the latest version of Universal PST software may be downloaded. Contact the Woodward sales department to request a DPG Software Calibration Kit for a nominal charge.

Downloading Universal PST:

The Universal PST application can be downloaded from the Woodward Software Products page at www.woodward.com/IC/Software. Use the "Select a Product" drop down menu in the center of the web page to select "DPG-2xxx digital controllers" then press the [Go] button.

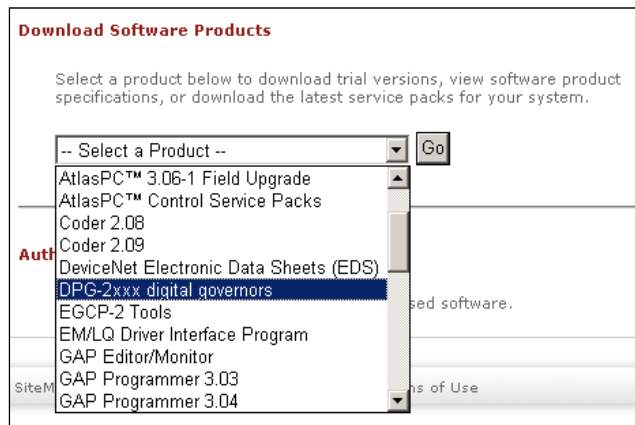

This will automatically redirect you to the Universal PST download page where you can click on the word **Download** to begin the download process. Once you are logged into the Woodward download site you are presented with the File Download dialog box shown below, or one similar. Click the [Save] button and choose a folder to save the download to.

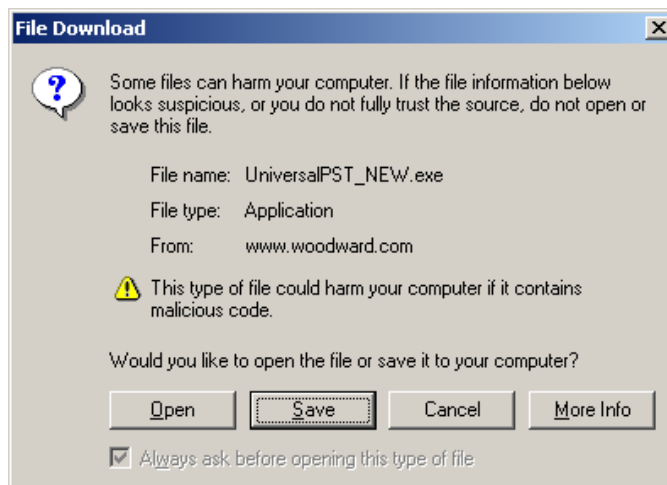

NOTE: Due to the large file size, it is recommended that the [Open] button not be used because this would try to run the self-extracting executable from the web site.

Installing Universal PST

After downloading the software file from the Woodward web site, run it and follow the installer instructions.

IMPORTANT:

The installation program will detect operating system components older than those required by the "Universal PST" application. In this case the installation program will ask if you want to update Windows. If you do not want "setup" to update your system then you cannot use the "Universal PST" application on this computer.

Read the setup program's instructions carefully as they appear and respond as needed. The installation may take as long as 7 minutes depending on your computer's power and operating system. Do not interrupt the installation program even though it may appear as though it is not running.

NOTE: Administrator rights may be needed to install on some Microsoft Windows operating systems (such as Windows XP Professional) for the setup program to properly register application resources.

Wiring the COMM Port to a PC

To construct a communications cable to use between the DPG's COMM port and your PC's RS-232 serial port refer to the table and wiring diagram below.

RJ11 OR RJ12 POSITION	DPG-21XX SIGNAL	CONNECTS TO:
1	No connection	N/C
2	Transmit data to PC	PC receive (RxD) DB9 pin 2
3	Receive data from PC	PC transmit (TxD) DB9 pin 3
4	COMMON	PC common DB9 pin 5
5	+5 Vdc (Do NOT connect at the PC end)	N/C
6	No connection	N/C

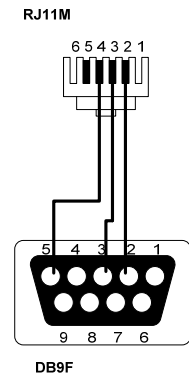

IMPORTANT	Remote access via the COMM port is intended for connection only while programming, tuning and troubleshooting the control/engine. It is a service port and not intended for permanent connection of a PC and/or cable.
------------------	--

Communications Error

The following message window appears when Universal PST is running and unable to communicate with a DPG.

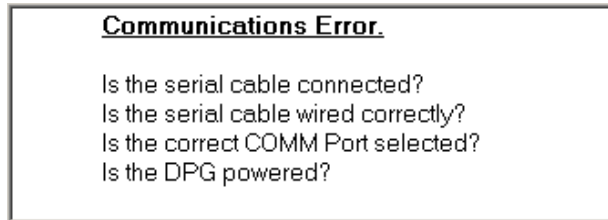

After the problem is found and corrected, you can either restart Universal PST or press the <Read All> button to clear the error message. The <Read All> button is near the lower left corner of Universal PST's main startup screen.

Universal PST User Interface Overview

Universal PST has two main display modes.

- Table View (the main startup screen)
- Chart View

TABLE VIEW

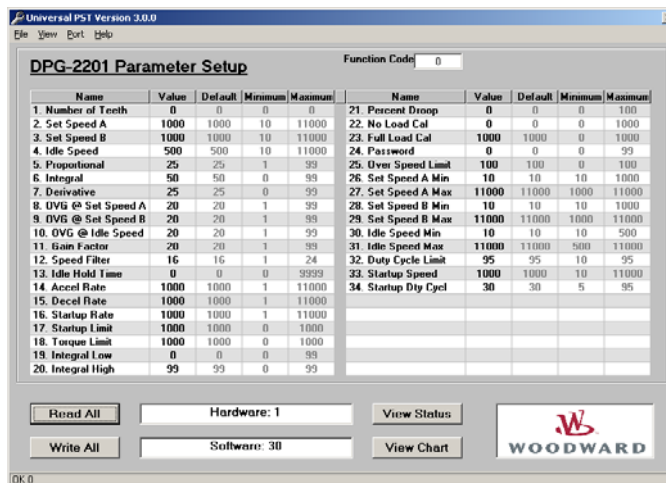

In Table View the user can:

- View the current values for all user programmable parameters in the Parameter Setup panel.
- Edit a parameter's value by double-clicking on a cell in the "Value" column of the table.
- Press the <Read All> button to refresh the values displayed in the Parameter Setup panel.
- Press the <Write All> button to transmit setup values to the controller.
- Press the <View Status> button to display read only parameters in the Status View panel.

- Press the <View Chart> button to set the display mode to Chart View.
- Select items from the menu.

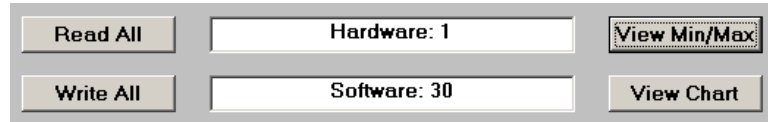
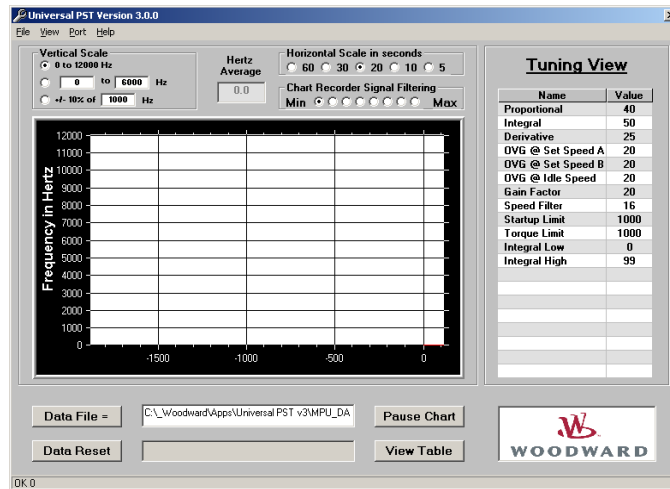
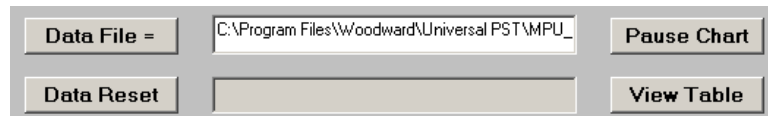

CHART VIEW



In Chart View the user can:

- Monitor engine speed in real-time.
- Adjust the horizontal and vertical scale settings of the chart recorder.
- Edit parameter values related to controller tuning. These same parameters are also on the main parameter setup table.
- Press the <Data File => button to open a file for saving chart recorder data.
- Press the <Data Reset> button to start data collection to the open file at the beginning.
- Press the <Pause Chart> button to stop the chart recorder, which also stops writing data to the file. Press the <Continue> button to turn the chart recorder back on.
- Press the <View Table> button to set the display mode back to Table View.
- Select items from the menu.



NOTE: Pressing a button means positioning the mouse pointer over the button and clicking the left mouse button.

Universal PST Menu Items

Use the **File** menu to:

- Open a previously saved setup data file
- Save setup data to a file
- Send setup data to the default printer
- Exit the program

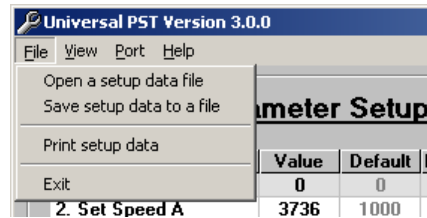

Use the **View** menu to:

- Select Parameter Table view (Table View)
- Select Chart Recorder view (Chart View)

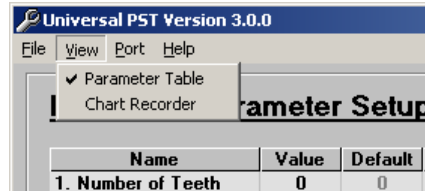

Use the **Port** menu to:

- Select the PC's serial port that is connected to the DPG-21XX-00X

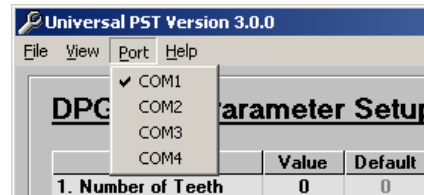

Use the **Help** menu to access:

- Help on the Universal PST for DPG
- Help on the DPG-21XX-00X that is currently in communication with the PC
- Information about the Universal PST for DPG application

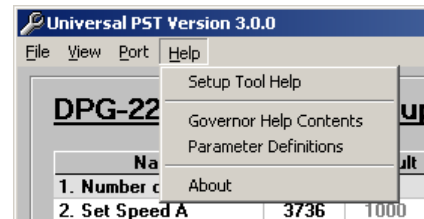

Parameter Setup

The Parameter Setup panel displays a table where each row shows the Name of a user programmable parameter, its current Value, and the parameter's Default, Minimum, and Maximum values.

To modify a parameter's current value, it must first be selected. Do this by double-clicking the left mouse button on a cell in the table that is at the intersection of the parameter's row and the Value column. The selected cell will be highlighted and the value can now be modified. When done modifying the value, press the computer keyboard's <Enter> key to transmit the new value to the controller.

In the figure shown below, the Set Speed A value has been selected for editing.

Name	Value	Default	Minimum	Maximum
1. Number of Teeth	0	0	0	0
2. Set Speed A	3736	1000	10	11000
3. Set Speed B	1000	1000	10	11000
4. Idle Speed	477	500	10	11000
5. Proportional	40	25	1	99
6. Integral	50	50	0	99
7. Derivative	25	25	0	99

Parameter Help

To get help on a particular parameter, single click the left mouse button on a parameter's Value, then press <Ctrl><F1> on the computer's keyboard. <Ctrl><F1> means press and hold the <Ctrl> key while the <F1> key is pressed and released. This opens the DPG online help file and automatically jumps to the selected parameter's help page.

NOTE: Complete online help for each DPG controller is also accessible by selecting either “Governor Help Contents” or “Parameter Definitions” from the Universal PST Help menu.

Synchronizing Universal PST with a DPG

Pressing the <Read All> button will load the current values for all of a DPG-2XXX-00X's parameters into Universal PST. The <Read All> button is part of the Table View.

IMPORTANT: If the communication cable is unplugged from a DPG and plugged into a different DPG while the Universal PST application is still running, then the <Read All> button must be pressed in order for Universal PST to synchronize with the new DPG.

The <Write All> button is very useful when reusing saved setup data to configure a new system with the same data as a previous one. Simply load an existing set of previously saved parameter values into the Parameter Setup table using “Open a setup data file” from the File menu then press the <Write All> button.

Status View

The Status View panel is displayed only after pressing the <View Status> button. The Status View panel is part of the Table View display mode.

The Status View panel displays a table where each row shows the Name of a read only parameter and its current Value (when “Auto Read is ON”)

Press (left mouse click) the <START Monitoring> button to have the Universal PST program automatically refresh the Values. Press the <STOP Monitoring> button to disable automatic refresh.

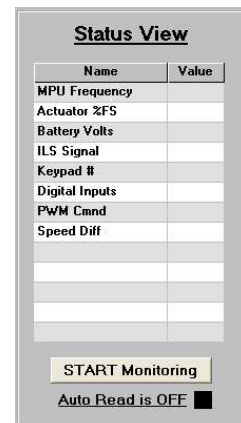

Tuning View

The Tuning View panel is displayed only after pressing the <View Chart> button. The Tuning View panel is part of the Chart View display mode.

To modify a tuning parameter's current value, it must first be selected. Do this by double-clicking the left mouse button on a cell in the table that is at the intersection of the parameter's row and the Value column.

The selected cell will be highlighted and the value can now be modified. When done modifying the value, press the computer keyboard's <Enter> key to transmit the new value to the controller.

Tuning View	
Name	Value
Proportional	50
Integral	20
Derivative	10
Overall Gain	10
Ki Slow/Fast	1
Engine Size	2
Startup Limit	100
Torque Limit	100
Integral Low	0
Integral High	100

Chart Recorder

The chart recorder is part of the Chart View display mode. Each time Chart View is entered the last used Data File is reset, the Vertical Scale defaults to [0 Hz to 12000 Hz], and the Horizontal scale defaults to 20 seconds.

The chart recorder's display characteristics are configured using the Vertical Scale options, the Horizontal Scale options, and the Chart Recorder Signal Filtering options.

The Vertical Scale options provide three different ways to view engine speed data.

- The [0 to 12000 Hz] option is the default and sets the vertical axis range to its absolute minimum and maximum measurable values.
- The [_____] to [_____] Hz option allows you to enter the minimum and maximum speed values to zoom in on a viewing range of interest.
- The +/- 10% of [_____] Hz option is primarily used to zoom in on the target speed and center it in the chart recorder. This is most useful during controller tuning to see if the engine speed stays within +/- 10% of the target speed during load on/off cycling.

The Horizontal Scale options allow you to set how much data is displayed in the chart recorder window. Larger values compress the display and show more data. Smaller numbers expand the display and show less data. A Horizontal Scale setting of 20 seconds is approximately the same as a 5-millimeter per second paper travel speed of a conventional paper tape chart recorder.

The Chart Recorder Signal Filtering options can be used to smooth out noisy signals. The default setting is Min, which is no filtering. Note that filtering will round out peaks and give a less accurate display of the speeds actually measured by the DPG.

Engine Speed Data Collection

The engine speed data measured by the DPG and displayed in the Universal PST chart recorder window is also recorded to a computer file.

MPU_DATA00.csv is the default file name used to save engine speed information. You can change the file name by using the <Data File => button. The “.csv” data files created to collect engine speed data can be viewed with either a text editor or with Microsoft Excel. If you load an engine speed data file into Microsoft Excel, then you can highlight the column of data and use Excel's quick graph button to create a line chart of the data.

IMPORTANT: Do not open data files in another program that are currently being used by Universal PST. Also be sure to close any open data files needed by Universal PST before starting it.

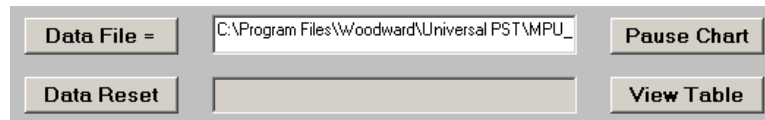

The <Data File => button opens a dialog box allowing you to set the base file name where chart recorder data will be saved. A two-digit suffix is automatically appended to the file name that is given and serves the following purpose. Each engine speed data file is considered full after recording 60,000 data points which is approximately 10-12 minutes of data. The two-digit suffix is used to automatically continue collecting data to new files with the same base file name but with increasing numeric suffixes. The first 60,000 data points are saved in *filename00.csv* and the next 60,000 data point are saved in *filename01.csv*, and so on until a million data points are collected. This is to prevent each speed data file from exceeding the 65,536-row limit of Microsoft Excel.

The <Data Reset> button is used to clear out the data collection buffer and overwrite the zero suffixed data collection file. Data collection starts from the beginning of *filename00.txt* where *filename* is the base file name previously used.

The progress bar shown to the right of the <Data Reset> button indicates how full the complete set of data files is. A total of one million data points (approximately 3.5 hours of data) can be collected before the progress bar displays the message “The Data File is FULL”. In order to start recording data again without overwriting previously collected data, use the <Data File => button to create a new base file name in which to receive additional engine speed information.

The <Pause Chart> button stops chart recorder and Data File updates. After pressing this button the <Continue> button is displayed. Press the <Continue> button to turn the chart recorder back on and continue recording engine speed data to the current target file.

Use the <View Table> button to return to the Table View display mode. Be sure to open a new Data File before returning to Table View if the data already collected needs to be saved. The active data file is automatically reset each time the Chart View display mode becomes active.

Chapter 5.

Calibration Instructions

Basic Adjustments

The controller is programmed at the factory with default parameter settings. These settings allow the controller to operate but usually require some further adjustments to obtain the best system performance. In order to bring the engine up to a single speed for the first time, the installer will probably need to adjust the parameters shown in the table below.

The parameters listed are the primary ones to modify to get the controller tuned and the engine running smoothly. It is recommended that you work with them first and leave all the other parameters at their default values until you are satisfied with the basic engine tuning.

No.	Parameter Name	Default Value
2	SET SPEED A	1000
5	PROPORTIONAL	25
6	INTEGRAL	50
7	DERIVATIVE	25
8	OVG @ SET SPEED A	20
11	GAIN FACTOR (note 1)	20
12	SPEED FILTER (note 2)	16
28	STARTUP SPEED	1000

NOTE 1: Modify Gain Factor only if you run out of adjustment in a PID or OVG term.

NOTE 2: For the Speed Filter, typically the value 24 works well on small 3- or 4-cylinder engines. A value of 16 is recommended for 6- or 8-cylinder engines.

Tuning Methodology

Once the engine is running, the following procedure may be used to discover more optimum values for PID and the overall gain parameters (OVG). The goal would be to find PID values that allow the controller to govern the engine well at a variety of different speeds and loads while only requiring gain adjustment at those different speeds.

Follow these steps:

1. Set the integral and derivative terms to 0.
2. Set the overall gain low (<20).
3. Increase the proportional term until you get continuous oscillations greater than 2 Hz.
4. Reduce the proportional term by 25% to 50%.
5. Now experiment with small value changes in the derivative to dampen out "ringing" in response to load transients.
6. Add some integral to eliminate any steady-state error in the engine's speed and help decrease error recovery time.
7. The overall gain can be increased to improve response time while keeping the ratios of the PID terms relative to each other constant.

During each of the steps 3 through 6, you need to disturb the system by adding and removing a load from the engine to check the controller's response to the load transition. **START WITH SMALL LOADS.**

Note that without integral, a speed error may persist after a load-on load-off transition. Therefore, during steps 3-5 you should temporarily increase the integral to get the engine speed back to the set speed, and then reset the integral to a lower value again while working to find good proportional and derivative values. Repeat steps 3-7 as needed to find a Proportional value, Integral value, and a Derivative value that work well with a variety of overall gain values and different load transients.

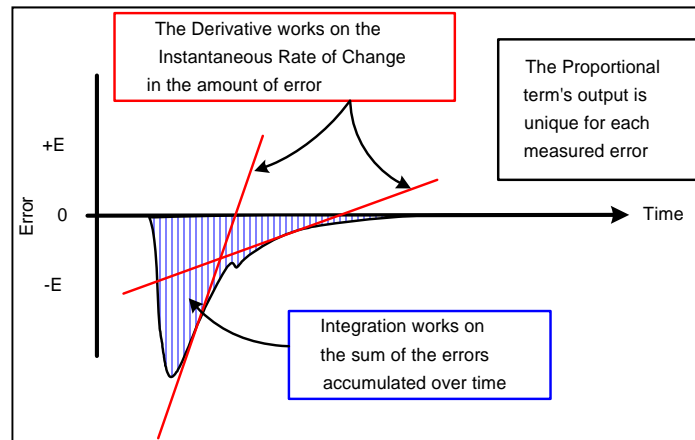

Startup Sequence

The following example describes the DPG-21XX-00X startup sequence.

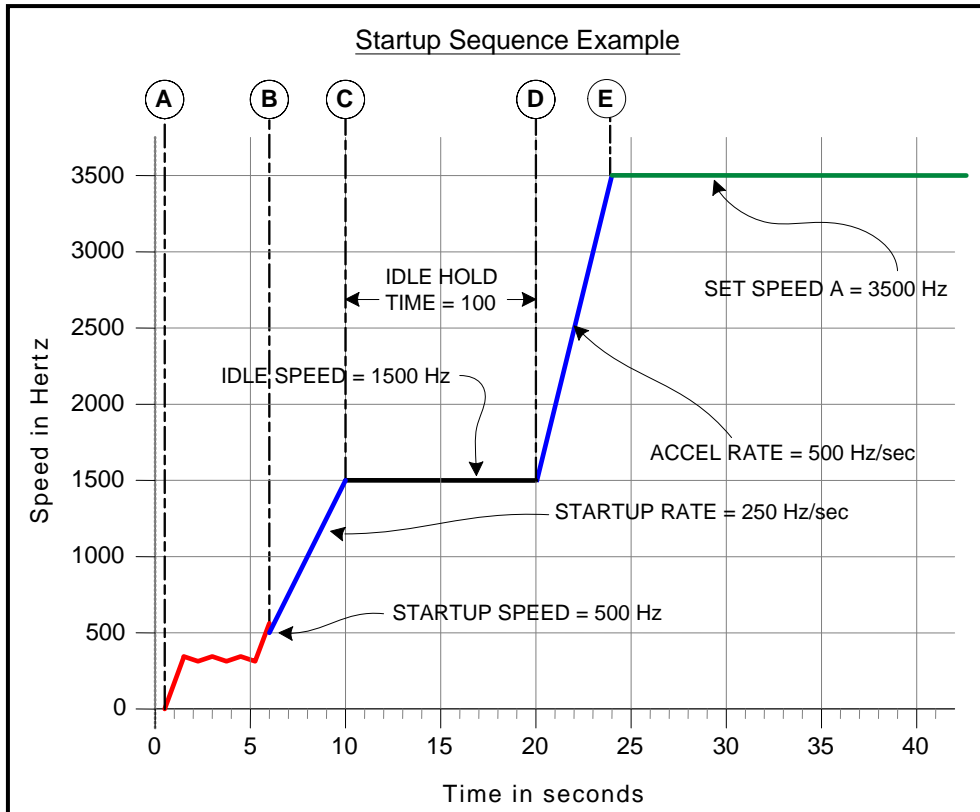

Engine cranking begins at point A. After a short time, the engine starts and at point B the engine speed exceeds the STARTUP SPEED (the initial target speed) and the controller now considers the engine to be running.

The controller's startup sequence begins at point B by ramping the target speed up from the STARTUP SPEED at the STARTUP RATE. In this example, the STARTUP SPEED is set to 500 Hertz, the STARTUP RATE is set equal to 250 Hertz per second, and the IDLE SPEED is set to 1500 Hertz. It will take 4 seconds for the target speed to ramp up 1000 Hertz (IDLE SPEED minus STARTUP SPEED) and reach point C.

This example uses the IDLE HOLD TIME and has it set to 100 tenths of a second so the target speed will be held at the IDLE SPEED (1500 Hertz in this example) for 10 seconds. At point D, the IDLE HOLD TIME has elapsed and the target speed is ramped up at the ACCEL RATE. In this example, the ACCEL RATE is set equal to 500 Hertz per second.

The example also has SET SPEED A set at 3500 Hertz so it will take 4 seconds for the target speed to ramp up 2000 Hertz from the IDLE SPEED. Ramping stops at point E when the target speed reaches SET SPEED A. The startup sequence also ends at point E assuming the engine speed has been tracking the target speed and has reached SET SPEED A.

Chapter 6. Installation Instructions

Recommended Mounting

The DPG-21XX-00X controller is designed to be panel mounted and its chassis electrically bonded to the same protective reference as the engine structure. The mounting location should protect the controller from exposure to rain, weather, and direct sunlight. The controller should not be mounted on the engine or in an environment that exceeds the mechanical specifications outlined in Chapter 2 of this manual. The controller should be mounted in a position to allow access to the user interface, the COMM port and the terminal strip.

Terminal Descriptions

DPG-2101-00X

NO.	NAME	FUNCTION
1	BAT+	Battery positive (9–30 Vdc)
2	BAT-	Battery negative
3	ACT	Actuator drive output
4	ACT	Actuator drive return
5	MPU+	Magnetic pickup signal input
6	MPU-	Magnetic pickup ground
7	SHIELD	Ground connection for cable shielding

DPG-2145-00X

NO.	NAME	FUNCTION
1	BAT+	Battery positive (9–30 Vdc)
2	ACT	Actuator drive output
3	Not Labeled	Digital input common
4	INC	Digital input to increase selected set speed (Active when tied to Pin 3)
5	IGN TACH	Ignition tachometer signal input
6	SET SPD 2	Set Speed B selected when this pin tied to Pin 12
7	BAT-	Battery negative
8	ACT	Actuator drive return
9	SHIELD	Ground connection for cable shielding
10	DEC	Digital input to decrease selected set speed (Active when tied to Pin 3)
11	IGN GND	Ignition ground signal
12	SET SPD 1	Set Speed A selected when this pin is open

DPG-2146-00X

NO.	NAME	FUNCTION
1	BAT+	Battery positive (9–30 Vdc)
2	BAT-	Battery negative
3	ACT	Actuator drive output
4	ACT	Actuator drive return
5	IGN TACH	Ignition tachometer signal input
6	IGN GND	Ignition ground signal
7	SHIELD	Ground connection for cable shielding

DPG-2155-00X

NO.	NAME	FUNCTION
1	BAT+	Battery positive (9–30 Vdc)
2	ACT	Actuator drive output
3	Not Labeled	Digital input common
4	INC	Digital input to increase selected set speed (Active when tied to Pin 3)
5	MPU+	Magnetic pickup signal inputs
6	SET SPD 2	Set Speed B selected when this pin tied to Pin 12
7	BAT-	Battery negative
8	ACT	Actuator drive return
9	SHIELD	Ground connection for cable shielding
10	DEC	Digital input to decrease selected set speed (Active when tied to Pin 3)
11	MPU-	Magnetic pickup ground
12	SET SPD 1	Set Speed A selected when this pin is open

NOTICE

To prevent damage to the controller, make sure that it is wired in accordance with the wiring instructions and diagrams in this manual.

- Do not tin the leads before placing them into the terminals.
- Ensure the terminals are tightened properly to secure wires.

Wiring Diagrams

NOTICE	<p>Cabling for DPG 21XX-00X controllers is limited to less than 30m (98.4'). Power cabling is limited to less than 10m (32.8') in total length. The wiring diagrams below show specific cable types required.</p>
--------	---

DPG-2101-00X

Dimensions are in inches. [Dimensions in brackets are millimeters.]

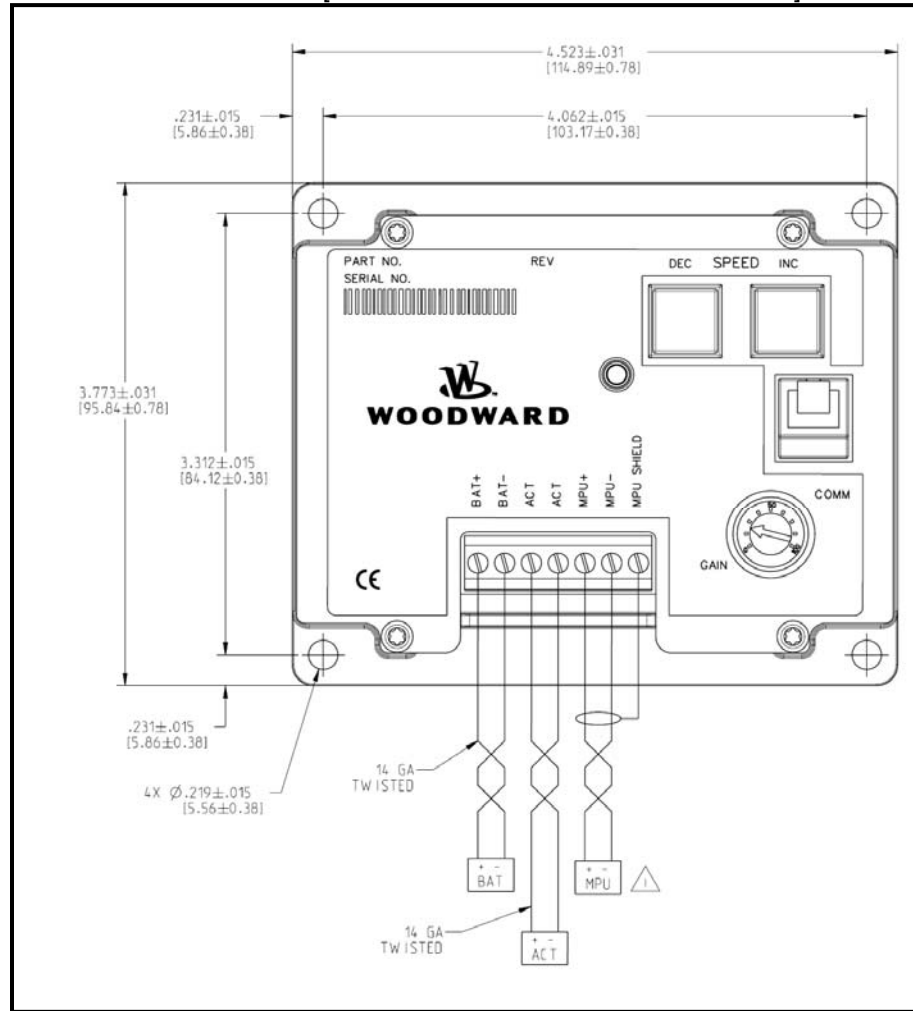

Figure 1. Wiring Diagram for DPG-2101-001 and DPG-2101-002 Controllers

- 1 Connect the MPU shield at the controller end only. Connecting the shield at the MPU source end could introduce noise due to ground loops and also disable the reverse battery protection feature.

DPG-2145-00X

Dimensions are in inches. [Dimensions in brackets are millimeters.]

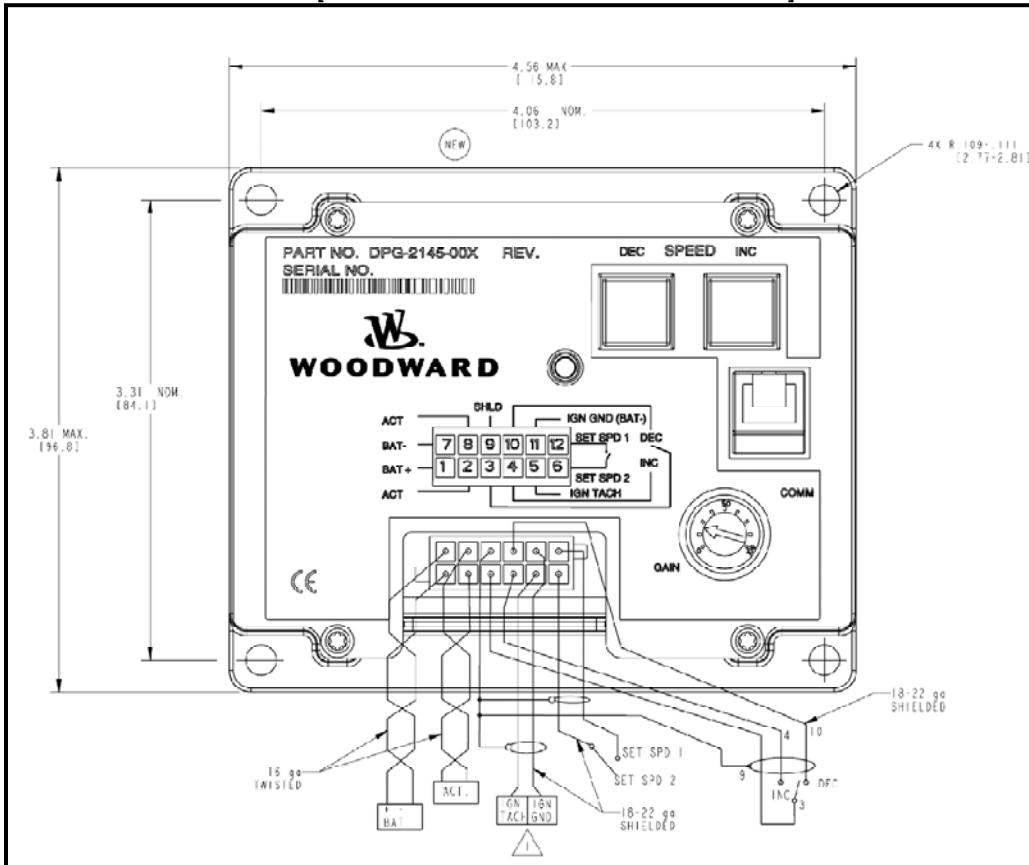

Figure 2. Wiring Diagram for DPG-2145-001 and DPG 2145-002 Controllers

- 1 Connect the MPU shield at the controller end only. Connecting the shield at the MPU source end could introduce noise due to ground loops and also disable the reverse battery protection feature.

NOTICE	<p>To prevent damage to the controller, make sure that it is wired in accordance with the wiring instructions and diagrams in this manual.</p> <ul style="list-style-type: none"> Do not tin the leads before placing them into the terminals. Ensure the terminals are tightened properly to secure wires.
---------------	---

DPG-2146-00X

Dimensions are in inches.

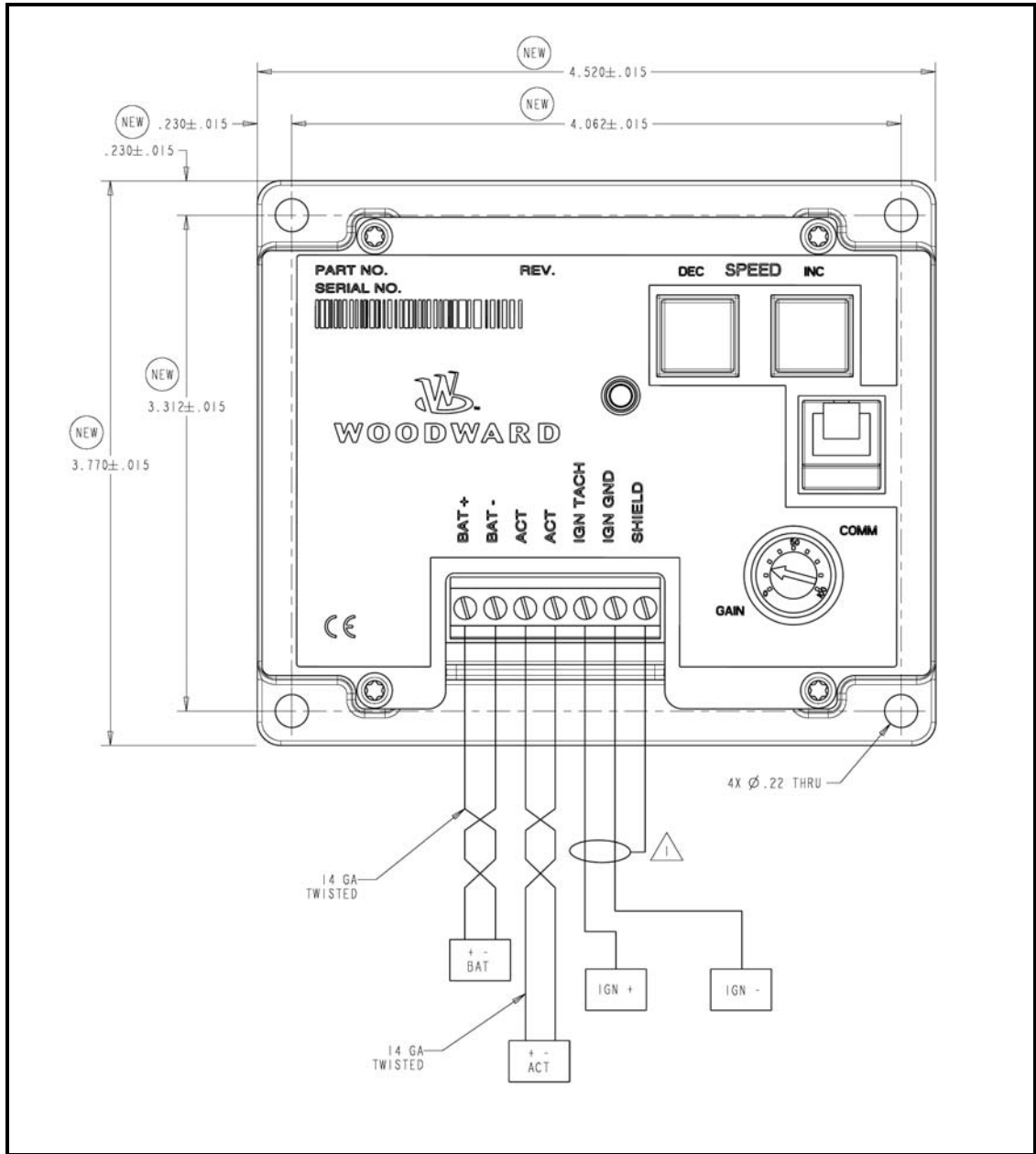

Figure 3. Wiring Diagram for DPG-2146-001 and DPG-2146-002 Controllers

1 Connect the MPU shield at the controller end only. Connecting the shield at the MPU source end could introduce noise due to ground loops and also disable the reverse battery protection feature.

DPG-2155-00X

Dimensions are in inches. [Dimensions in brackets are millimeters.]

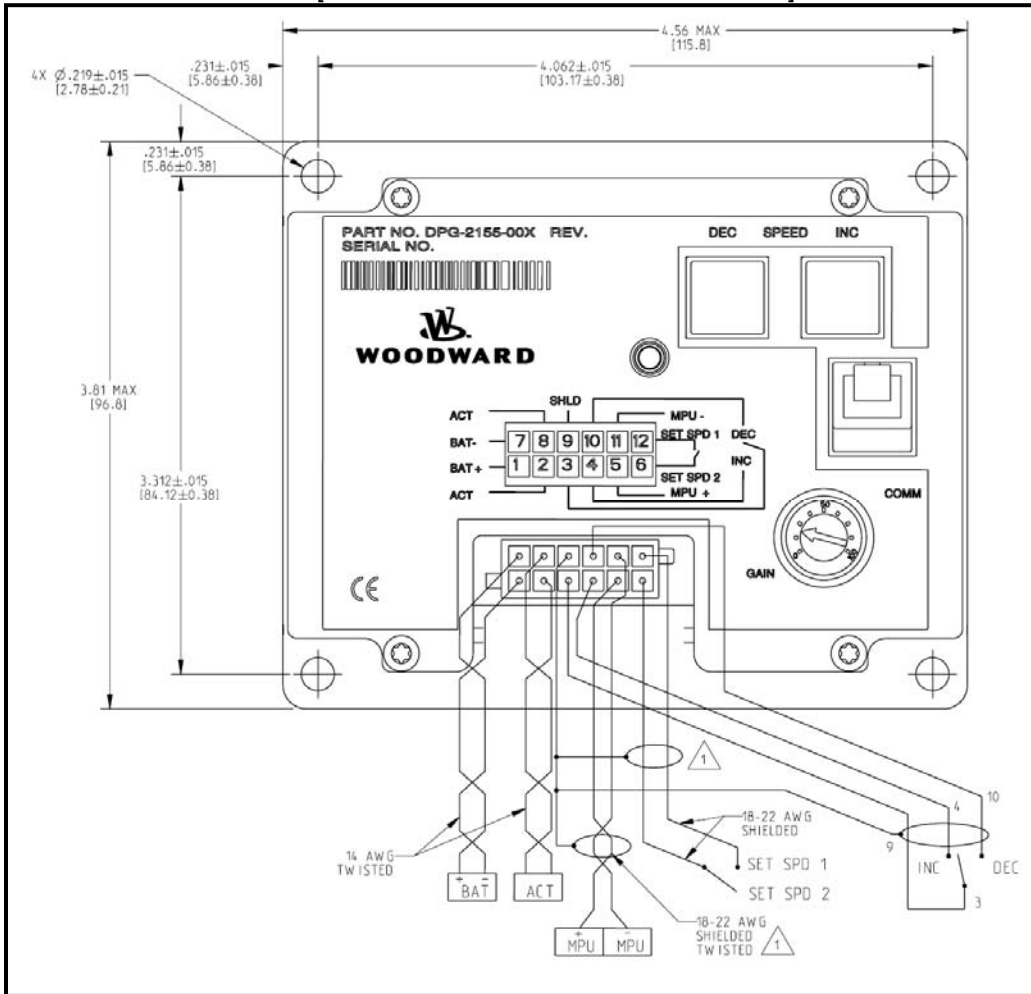

Figure 4. Wiring Diagram for DPG-2155-001 and DPG-2155-002 Controllers

1 Connect the MPU shield at the controller end only. Connecting the shield at the MPU source end could introduce noise due to ground loops and also disable the reverse battery protection feature.

NOTICE	<p>To prevent damage to the controller, make sure that it is wired in accordance with the wiring instructions and diagrams in this manual.</p> <ul style="list-style-type: none"> Do not tin the leads before placing them into the terminals. Ensure the terminals are tightened properly to secure wires.
---------------	---

Centralized Suppression

The control meets the regulatory requirements for its intended installations, and when installed correctly as directed, the DPG input power can handle some level of surge pulses.

Because the control power input is designed to be connected to a local bus and to have inductive load kickbacks suppressed, it cannot withstand a charging system load dump, heavy inductive kickbacks, or heavy surge pulses.

1. Charging system load dump is a pulse created when a heavily charging battery that is being charged by an alternator or generator (or similar), is disconnected from the bus.
2. Inductive kickbacks are due to series or parallel switched, unsuppressed, inductive loads switched ON and OFF wired on the same power bus.
3. Large surge pulses are typically due to indirect lightning strikes. Some surge pulses may also be present due to series inductances with switched currents.

The EMC environment into which the control is installed may have the above conditions if the control is installed OUTSIDE its intended usage. If the stated conditions exist, centralized pulse suppression should be implemented to protect the components on the bus, including the control.

Figure 2 is an example of centralized suppression that should be implemented at the system level when any of the following are present:

1. The battery can be disconnected and an unsuppressed high current battery charging system is in use.
2. Unsuppressed, switched inductive loads are in parallel or series with the control power.
3. The input power is derived from a distribution system or it is more than 32.8' (10m) from the control to the main power source.

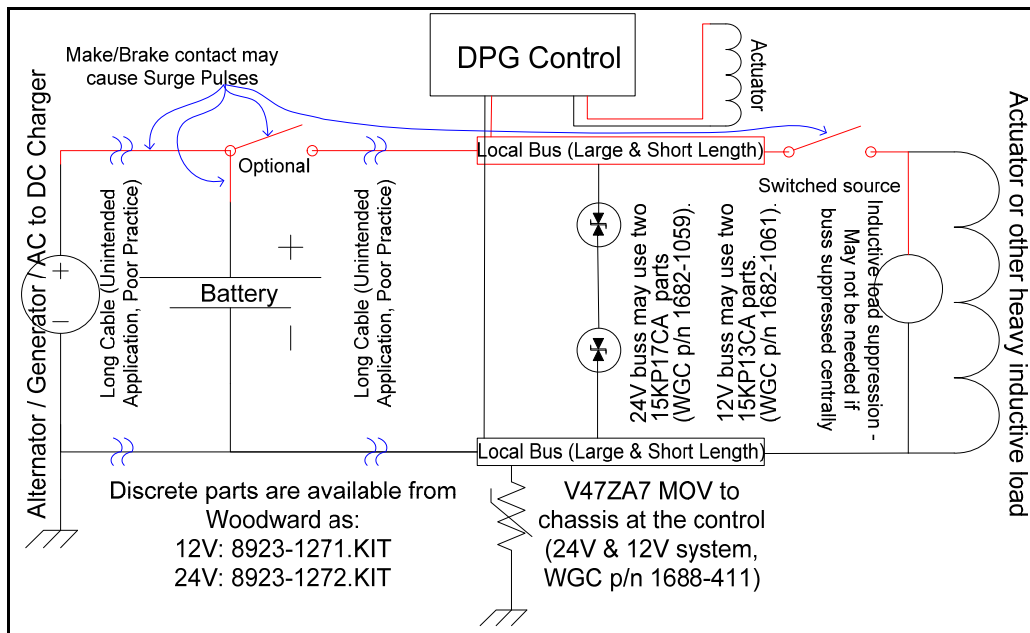

Figure 5. Centralized Suppression Implemented at the System Level

FIGURE 5 NOTES:

1. Power and return cables to the control are routed together to minimize the noise pickup and emissions. Similarly, the power and return to the actuator must also be routed together, but may be separated from the control's power leads.
2. MOV and TVS suppression devices are recommended based on the typical pulse levels that might be seen in Group 1 or Group 2 engine applications and the internal circuitry of the control.
3. Other suppression devices may be used, but clamping voltages and energy handling capability are important, as operating voltage and energy handling capability requirements depend on the full system implementation.

Examples:

- (a) Two 15KP17CA and V47ZA7 through-hole parts are available from Woodward as 8923-1272.KIT. This kit is for a 24V system. It will suppress alternator load dump from alternators within the 200A range, as well as indirect lightning pulses that may be coupled to the power bus. Parallel inductive loads still need to be suppressed because pulses from unsuppressed parallel loads will be clamped at voltages too high to protect the control.
 - (b) Two 15KP13CA and one V47ZA7 through-hole parts are available from Woodward as 8923-1271.KIT. This kit is for a 12V system with an alternator within the 100A range, unsuppressed switched inductive loads in parallel with the control, and indirect lightning pulses that may be coupled to the power bus.
4. Suppression kits available from Woodward are intended to suppress the majority of the likely pulses. However, they will not protect against all system level implementations outside the intended usage of the control. A system level evaluation of what pulses may be present should be undertaken.

Please see Application Note 51319 for more details.

Chapter 7.

Diagnostics & Troubleshooting

LED Indications

LED STATE	MEANING
Off	Controller is either not currently powered, or is being reverse powered. (Check polarity of supplied power.) If correctly powered, then controller is malfunctioning.
Blinking Slow (1/2 Hz)	Controller is powered, but not sensing a speed signal. OK if engine is not running. If the engine is running, then this indicates a fault with the speed signal.
Blinking Fast (1½ Hz)	Controller is powered and an engine speed signal is being detected. If the engine is not running, then this indicates electrical noise on the speed signal wires.
ON and Not Blinking	Controller is powered and is malfunctioning. Replace controller.

Troubleshooting Table

SYMPTOM	REMEDY
LED Display Does Not Light Up When Controller Is Powered	BAT + and BAT – leads are reversed. Check wiring. Battery voltage too low. Should measure between 9–30 Vdc. Controller is defective. Replace it.
Unable to Modify Parameters	The parameter's value is the maximum value allowed. The parameter's value is the minimum value allowed. Universal PST not communicating with the controller. Keypad failure, replace unit.
Engine Does Not Start	Actuator leads not connected or shorted. No fuel source. Turn on fuel source. Battery voltage is low. Charge or replace the battery. Set speed is lower than crank speed. Increase the set speed. Startup Rate setting is too low. The target speed ramps up too slow. Startup Limit is too low, limiting the actuator drive signal too much. Is the MPU speed signal present? It should read 2.0 VRMS minimum. Adjust magnetic pickup (MPU) gap. Try reversing the MPU leads. If a speed signal is present, measure actuator output duty cycle. If not greater than 5%, then restore all parameter values to factory default settings and crank the engine again. Final target speed must be greater than crank speed before the controller will attempt to drive the actuator open.
Engine Overspeeds at Startup	Increase the Proportional value. Increase the appropriate Gain value. Decrease the Startup Ramp Rate.

Troubleshooting Table (Cont'd.)

SYMPTOM	REMEDY
Engine Does Not Reach Set Speed	<p>Improve PID tuning. Integral too low or zero PID values are too low. A tuning that is too soft can prevent the controller from delivering the needed actuator drive signal to reach the set speed.</p> <p>PID values are too high. Tuning is too hot or oversensitive to small speed errors, which causes the controller to make large, rapid changes in actuator drive signal, creating an average signal that is inadequate.</p> <p>The Integral Low Limit setting is too high. Return the value to the default setting of zero.</p> <p>The Integral High Limit setting is too low. Return the value to the default setting of 99.</p>
Engine Takes Too Long to Reach the Set Speed	<p>Improve PID tuning. Integral setting is too low. Startup Rate setting is too low. Accel Rate setting is too low. Speed Filter setting is too high.</p>
Engine Does Not Track Speed Setting Changes	<p>Is the LED blinking fast (3 Hz)? No = not sensing speed. Is the selected set speed parameter being modified? A PID value or a Gain value is too high. A PID value is too low or zero. Accel Rate is set too low. Decel Rate is set too low.</p>
Sluggish Response to Load Changes	<p>Gain too low. Improve PID tuning. Speed filter setting is too high.</p>
Engine Instability With No Load	<p>Improve PID tuning. Speed filter setting is too low. Fuel is restricted. Check actuator linkage. Battery voltage is too low.</p>
Engine Instability With Load	<p>Improve PID tuning. Fuel is restricted. Check actuator linkage. Battery voltage is too low.</p>
Engine Unable to Carry Rated Load	<p>PID values may be too high, causing the controller to overreact and make large, rapid changes in PWM duty cycle output to the actuator.</p> <p>Improve PID tuning. Fuel is restricted. Check actuator linkage.</p>

Chapter 8. Service Options

Product Service Options

If you are experiencing problems with the installation, or unsatisfactory performance of a Woodward product, the following options are available:

- Consult the troubleshooting guide in the manual.
- Contact the manufacturer or packager of your system.
- Contact the Woodward Full Service Distributor serving your area.
- Contact Woodward technical assistance (see “How to Contact Woodward” later in this chapter) and discuss your problem. In many cases, your problem can be resolved over the phone. If not, you can select which course of action to pursue based on the available services listed in this chapter.

OEM and Packager Support: Many Woodward controls and control devices are installed into the equipment system and programmed by an Original Equipment Manufacturer (OEM) or Equipment Packager at their factory. In some cases, the programming is password-protected by the OEM or packager, and they are the best source for product service and support. Warranty service for Woodward products shipped with an equipment system should also be handled through the OEM or Packager. Please review your equipment system documentation for details.

Woodward Business Partner Support: Woodward works with and supports a global network of independent business partners whose mission is to serve the users of Woodward controls, as described here:

- A **Full Service Distributor** has the primary responsibility for sales, service, system integration solutions, technical desk support, and aftermarket marketing of standard Woodward products within a specific geographic area and market segment.
- An **Authorized Independent Service Facility (AISF)** provides authorized service that includes repairs, repair parts, and warranty service on Woodward's behalf. Service (not new unit sales) is an AISF's primary mission.
- A **Recognized Engine Retrofitter (RER)** is an independent company that does retrofits and upgrades on reciprocating gas engines and dual-fuel conversions, and can provide the full line of Woodward systems and components for the retrofits and overhauls, emission compliance upgrades, long term service contracts, emergency repairs, etc.
- A **Recognized Turbine Retrofitter (RTR)** is an independent company that does both steam and gas turbine control retrofits and upgrades globally, and can provide the full line of Woodward systems and components for the retrofits and overhauls, long term service contracts, emergency repairs, etc.

A current list of Woodward Business Partners is available at www.woodward.com/support/directory.cfm.

Woodward Factory Servicing Options

The following factory options for servicing Woodward products are available through your local Full-Service Distributor or the OEM or Packager of the equipment system, based on the standard Woodward Product and Service Warranty (5-01-1205) that is in effect at the time the product is originally shipped from Woodward or a service is performed:

- Replacement/Exchange (24-hour service)
- Flat Rate Repair
- Flat Rate Remanufacture

Replacement/Exchange: Replacement/Exchange is a premium program designed for the user who is in need of immediate service. It allows you to request and receive a like-new replacement unit in minimum time (usually within 24 hours of the request), providing a suitable unit is available at the time of the request, thereby minimizing costly downtime. This is a flat-rate program and includes the full standard Woodward product warranty (Woodward Product and Service Warranty 5-01-1205).

This option allows you to call your Full-Service Distributor in the event of an unexpected outage, or in advance of a scheduled outage, to request a replacement control unit. If the unit is available at the time of the call, it can usually be shipped out within 24 hours. You replace your field control unit with the like-new replacement and return the field unit to the Full-Service Distributor.

Charges for the Replacement/Exchange service are based on a flat rate plus shipping expenses. You are invoiced the flat rate replacement/exchange charge plus a core charge at the time the replacement unit is shipped. If the core (field unit) is returned within 60 days, a credit for the core charge will be issued.

Flat Rate Repair: Flat Rate Repair is available for the majority of standard products in the field. This program offers you repair service for your products with the advantage of knowing in advance what the cost will be. All repair work carries the standard Woodward service warranty (Woodward Product and Service Warranty 5-01-1205) on replaced parts and labor.

Flat Rate Remanufacture: Flat Rate Remanufacture is very similar to the Flat Rate Repair option with the exception that the unit will be returned to you in “like-new” condition and carry with it the full standard Woodward product warranty (Woodward Product and Service Warranty 5-01-1205). This option is applicable to mechanical products only.

Returning Equipment for Repair

If a control (or any part of an electronic control) is to be returned for repair, please contact your Full-Service Distributor in advance to obtain Return Authorization and shipping instructions.

When shipping the item(s), attach a tag with the following information:

- return authorization number;
- name and location where the control is installed;
- name and phone number of contact person;
- complete Woodward part number(s) and serial number(s);
- description of the problem;
- instructions describing the desired type of repair.

Packing a Control

Use the following materials when returning a complete control:

- protective caps on any connectors;
- antistatic protective bags on all electronic modules;
- packing materials that will not damage the surface of the unit;
- at least 100 mm (4 inches) of tightly packed, industry-approved packing material;
- a packing carton with double walls;
- a strong tape around the outside of the carton for increased strength.

NOTICE

To prevent damage to electronic components caused by improper handling, read and observe the precautions in Woodward manual 82715, *Guide for Handling and Protection of Electronic Controls, Printed Circuit Boards, and Modules*.

Replacement Parts

When ordering replacement parts for controls, include the following information:

- the part number(s) (XXXX-XXXX) that is on the enclosure nameplate;
- the unit serial number, which is also on the nameplate.

Engineering Services

Woodward offers various Engineering Services for our products. For these services, you can contact us by telephone, by email, or through the Woodward website.

- Technical Support
- Product Training
- Field Service

Technical Support is available from your equipment system supplier, your local Full-Service Distributor, or from many of Woodward's worldwide locations, depending upon the product and application. This service can assist you with technical questions or problem solving during the normal business hours of the Woodward location you contact. Emergency assistance is also available during non-business hours by phoning Woodward and stating the urgency of your problem.

Product Training is available as standard classes at many of our worldwide locations. We also offer customized classes, which can be tailored to your needs and can be held at one of our locations or at your site. This training, conducted by experienced personnel, will assure that you will be able to maintain system reliability and availability.

Field Service engineering on-site support is available, depending on the product and location, from many of our worldwide locations or from one of our Full-Service Distributors. The field engineers are experienced both on Woodward products as well as on much of the non-Woodward equipment with which our products interface.

For information on these services, please contact us via telephone, email us, or use our website: www.woodward.com/support.

How to Contact Woodward

For assistance, call one of the following Woodward facilities to obtain the address and phone number of the facility nearest your location where you will be able to get information and service.

Electrical Power Systems		Engine Systems		Turbine Systems	
FACILITY	PHONE NUMBER	FACILITY	PHONE NUMBER	FACILITY	PHONE NUMBER
Brazil-----	+55 (19) 3708 4800	Brazil-----	+55 (19) 3708 4800	Brazil-----	+55 (19) 3708 4800
China -----	+86 (512) 6762 6727	China -----	+86 (512) 6762 6727	China -----	+86 (512) 6762 6727
Germany:		Germany:		India-----	+91 (129) 4097100
Kempen ---	+49 (0) 21 52 14 51	Stuttgart-----	+49 (711) 78954-0	Japan -----	+81 (43) 213-2191
Stuttgart-----	+49 (711) 78954-0	India-----	+91 (129) 4097100	Korea -----	+82 (51) 636-7080
India-----	+91 (129) 4097100	Japan -----	+81 (43) 213-2191	Poland-----	+48 12 295 13 00
Japan -----	+81 (43) 213-2191	Korea -----	+82 (51) 636-7080	The Netherlands -	+31 (23) 5661111
Korea -----	+82 (51) 636-7080	The Netherlands -	+31 (23) 5661111	United States ----	+1 (970) 482-5811
Poland-----	+48 12 295 13 00	United States ----	+1 (970) 482-5811		
United States ----	+1 (970) 482-5811				

You can also contact the Woodward Customer Service Department or consult our worldwide directory (www.woodward.com/support/directory.cfm) for the name of your nearest Woodward distributor or service facility.

Technical Assistance

If you need to telephone for technical assistance, you will need to provide the following information. Please write it down here before phoning:

Your Name	_____
Site Location	_____
Phone Number	_____
Fax Number	_____
<hr/>	
Engine/Turbine Model Number	_____
Manufacturer	_____
Number of Cylinders (if applicable)	_____
Type of Fuel (gas, gaseous, steam,	_____
Rating	_____
Application	_____
<hr/>	
Control/Governor #1	
Woodward Part Number & Rev.	_____
Control Description or Governor Type	_____
Serial Number	_____
<hr/>	
Control/Governor #2	
Woodward Part Number & Rev.	_____
Control Description or Governor Type	_____
Serial Number	_____
<hr/>	
Control/Governor #3	
Woodward Part Number & Rev.	_____
Control Description or Governor Type	_____
Serial Number	_____

If you have an electronic or programmable control, please have the adjustment setting positions or the menu settings written down and with you at the time of the call.

We appreciate your comments about the content of our publications.

Send comments to: icinfo@woodward.com

Please reference publication **36526**



PO Box 1519, Fort Collins CO 80522-1519, USA
1000 East Drake Road, Fort Collins CO 80525, USA
Phone +1 (970) 482-5811 • Fax +1 (970) 498-3058

Email and Website—www.woodward.com

**Woodward has company-owned plants, subsidiaries, and branches,
as well as authorized distributors and other authorized service and sales facilities throughout the world.**

Complete address / phone / fax / email information for all locations is available on our website.