



**SmartGen**  
ideas for power

## HGM4000N

(HGM4010N/4020N/ 4010NC/4020NC/4010CAN/ 4020CAN)

### GENSET CONTROLLER

### USER MANUAL



**SMARTGEN (ZHENGZHOU) TECHNOLOGY CO., LTD.**



Chinese trademark

**SmartGen** English trademark

**SmartGen** — make your generator *smart*

**SmartGen Technology Co., Ltd.**

**No.28 Jinsuo Road**

**Zhengzhou**

**Henan Province**

**P. R. China**

**Tel:** 0086-371-67988888/67981888

0086-371-67991553/67992951

0086-371-67981000(overseas)

**Fax:** 0086-371-67992952

**Web:** [www.smartgen.com.cn](http://www.smartgen.com.cn)

[www.smartgen.cn](http://www.smartgen.cn)

**Email:** [sales@smartgen.cn](mailto:sales@smartgen.cn)

All rights reserved. No part of this publication may be reproduced in any material form (including photocopying or storing in any medium by electronic means or other) without the written permission of the copyright holder.

Applications for the copyright holder's written permission to reproduce any part of this publication should be addressed to SmartGen Technology at the address above.

Any reference to trademarked product names used within this publication is owned by their respective companies.

SmartGen Technology reserves the right to change the contents of this document without prior notice.

Table 1 - Software Version

Date	Version	Note
2016-11-10	1.0	Original release.
2018-09-10	1.1	"Table 7 Parameters Settings and Scope" adding "Manual Close Enable Selection", "Raise Speed Pulse Time" and "Drop Speed Pulse Time" parameters; modify details.

# CONTENTS

<b>1 OVERVIEW.....</b>	<b>5</b>
<b>2 PERFORMANCE AND CHARACTERISTICS .....</b>	<b>5</b>
<b>3 SPECIFICATION OPERATION .....</b>	<b>7</b>
<b>4 OPERATION .....</b>	<b>8</b>
4.1 KEY FUNCTION .....	8
4.2 CONTROLLER PANEL.....	9
4.3 AUTO START/STOP OPERATION.....	10
4.4 MANUAL START/STOP OPERATION.....	11
4.5 EMERGENCY START UP .....	11
<b>5 PROTECTION .....</b>	<b>12</b>
5.1 WARNINGS .....	12
5.2 SHUTDOWN ALARM .....	15
<b>6 WIRINGS CONNECTION.....</b>	<b>18</b>
<b>7 SCOPES AND DEFINITIONS OF PROGRAMMABLE PARAMETERS.....</b>	<b>21</b>
7.1 CONTENTS AND SCOPES OF PARAMETERS.....	21
7.2 ENABLE DEFINITION OF PROGRAMMABLE OUTPUT PORTS .....	29
7.3 DEFINED CONTENTS OF CONFIGURABLE INPUT PORTS.....	30
7.4 SELECTION OF SENSORS.....	31
7.5 CONDITIONS OF CRANK DISCONNECT SELECTION.....	32
<b>8 PARAMETERS SETTING .....</b>	<b>33</b>
8.1 CONTROLLER PARAMETER SETTING .....	33
8.2 CONTROLLER INFORMATION .....	34
8.3 LANGUAGE SELECTION .....	34
8.4 EVENT LOG .....	34
8.5 MAINTENANCE.....	34
<b>9 SENSOR SETTING .....</b>	<b>35</b>
<b>10 COMMISSIONING .....</b>	<b>36</b>
<b>11 TYPICAL APPLICATION.....</b>	<b>37</b>
<b>12 INSTALLATION .....</b>	<b>40</b>
12.1 FIXING CLIPS.....	40
12.2 OVERALL DIMENSION .....	40
<b>13 CONNECTIONS OF CONTROLLER WITH J1939 ENGINE.....</b>	<b>42</b>
13.1 CUMMINS ISB/ISBE.....	42
13.2 CUMMINS QSL9.....	42
13.3 CUMMINS QSM11 (import) .....	43
13.4 CUMMINS QSX15-CM570 .....	43
13.5 CUMMINS GCS-MODBUS.....	44
13.6 CUMMINS QSM11 .....	44
13.7 CUMMINS QSZ13 .....	44
13.8 DETROIT DIESEL DDEC III / IV.....	45
13.9 DEUTZ EMR2.....	45
13.10JOHN DEERE.....	46
13.11MTU MDEC.....	46
13.12MTU ADEC(SMART module) .....	46



---

13.13MTU ADEC(SAM module) .....	47
13.14PERKINS .....	47
13.15SCANIA .....	47
13.16VOLVO EDC3 .....	47
13.17VOLVO EDC4 .....	48
13.18VOLVO-EMS2.....	48
13.19Yuchai .....	49
13.20Weichai .....	49
<b>14 FAULT FINDING.....</b>	<b>50</b>

SmartGen

## 1 OVERVIEW

**HGM4000N** series genset controllers integrate digitization, intelligentization and network technology which are used for genset automation and monitor control system of single unit to achieve automatic start/stop, data measurement, alarm protection and etc. functions. It fit with LCD display, optional languages interface (Chinese, English, Spanish, Russian, Turkish, French, Portugal, and Polish), and it is reliable and easy to use.

**HGM4000N** series genset controllers adopt micro-processor technology with precision parameters measuring, fixed value adjustment, time setting and set value adjusting and etc. All parameters can be configured from front panel or through programmable interface (USB or RS485 interface) via PC. It can be widely used in all types of automatic genset control system with compact structure, advanced circuits, simple connections and high reliability.

## 2 PERFORMANCE AND CHARACTERISTICS

**HGM4000N** series controller has six types:

**HGM4010N/HGM4010NC/HGM4010CAN:** ASM (Automatic Start Module), it controls generator to start/stop by remote signal;

**HGM4020N/HGM4020NC/HGM4020CAN:** AMF (Auto Mains Failure), updates based on HGM4010N/HGM4010NC/HGM4010CAN, moreover, has mains electric quantity monitoring and mains/generator automatic transfer control function, especially for automatic system composed by generator and mains.

Main features as follows:

- 132x64 LCD with backlight, selectable language interface (Chinese, English, Spanish, Russian, Turkish, French, Portugal, and Polish), push-button operation.
- Hard-screen acrylic material been used to protect screen with great wear-resisting and scratch-resisting functions.
- Silicone panel and pushbuttons can be used in extreme temperature environment.
- RS485 communication interface enable “Three remote functions” (remote control, remote measuring and remote communication) according to MODBUS protocol.
- Equipped with CANBUS port and can communicate with J1939 genset. Not only can monitor frequently-used data (such as water temperature, oil pressure, speed, fuel consumption and so on) of ECU machine, but also control starting up, shutdown , raising speed and speed droop via CANBUS port (need controller with CANBUS interface).
- Suitable for 3-phase 4-wire, 3-phase 3-wire, single phase 2-wire, and 2-phase 3-wire systems with voltage 120/240V and frequency 50/60Hz;
- Collects and shows 3-phase voltage, current, power parameter and frequency of generator or mains.

### Mains

Line voltage (Uab, Ubc, and Uca)  
 Phase voltage (Ua, Ub, and Uc)  
 Frequency Hz  
 Phase sequence

### Generator

Line voltage (Uab, Ubc, and Uca)  
 Phase voltage (Ua, Ub, and Uc)  
 Frequency Hz  
 Phase sequence

### Load

Current Ia, Ib, Ic  
 Each phase and total active power P  
 Reactive power Q

A (unit)  
 kW (unit)  
 kvar (unit)

Apparent power	S	kVA (unit)
Power factor	PF	
Accumulate total generator power	W	kWh, kVarh, kVAh (unit)
Output percentage with load		%

- For Mains, controller has over and under voltage and loss of phase detection functions; for generator, controller has over and under voltage, over and under frequency, over current and over power detection functions.
- Precision measure and display parameters about Engine.
  - Temp. (WT) °C/°F both be displayed
  - Oil Pressure (OP) kPa/psi/bar all be displayed
  - Fuel Level (FL) %(unit) Fuel Quantity Left L(unit)
  - Speed (RPM) r/min (RPM)
  - Voltage of Battery V (unit)
  - Voltage of Charger V (unit)
  - Hour count accumulation
  - Start times accumulation
- Protection: automatic start/stop of the gen-set, ATS(Auto Transfer Switch) control with perfect fault indication and protection function.
- With ETS (energize to stop), idle control, pre-heat control and rise/drop speed control functions, which are all relay outputs.
- Parameter setting: parameters can be modified and stored in internal FLASH memory and cannot be lost even in case of power outage; most of them can be adjusted using front panel of the controller and also can be modified using PC via USB or RS485 port.
- With multiplex input port 4 and 5. Input port 4 can be configured as switch input port or fuel level sensor; input port 5 can be set as switch input port or programmable sensor. It can flexible applied in different occasions.
- Multiple temperature, pressure, oil pressure sensor can be used and self-defined directly.
- With one programmable sensor can be configured as temperature, pressure or liquid level sensor. It is achieved double temperature, pressure or liquid level sensor detections.
- Multiple crank disconnect conditions (speed sensor, oil pressure, generator frequency) are optional.
- With emergency start function.
- With flywheel tooth number automatic recognition function.
- Widely power supply range DC(8~35)V, suitable to different starting battery voltage environment.
- All parameters used digital adjustment, instead of conventional analog modulation with normal potentiometer, more reliability and stability.
- With maintenance function. Types (date and running time) can be optional and actions (warning, shutdown or trip and stop) can be set when maintenance time out.
- Event log, real-time clock, scheduled start & stop generator (can be set as start genset once a day/week/month whether with load or not). Maximum 99 event logs can be memorized.
- Waterproof security level IP65 due to rubber seal installed between the controller enclosure and panel fascia.
- Metal fixing clips enable perfect in high temperature environment.
- Modular design, anti-flaming ABS plastic enclosure, pluggable connection terminals and embedded installation way; compact structure with easy mounting.

### 3 SPECIFICATION OPERATION









Table 2 - Technical Parameters

Items	Contents
Operating Voltage	DC8.0V to DC35.0V, Continuous Power Supply.
Power Consumption	<3W (standby $\leq$ 2W)
Alternator Volt Input Range 3Phase 4Wire 3Phase 3Wire Single Phase 2Wire 2Phase 3Wire	AC15V-AC 360V (ph-N) AC30V - AC620V (ph-ph) AC15V - AC360V (ph-N) AC15V - AC360V (ph-N)
Alternator Frequency	50 Hz /60Hz
Speed sensor voltage	1.0V to 24.0V (RMS)
Speed sensor Frequency	10,000 Hz (max.)
Start Relay Output	5 A DC28V at supply output
Fuel Relay Output	5 A DC28V at supply output
Programmable Relay Output (1)	1 A DC28V at supply output
Programmable Relay Output (2)	1 A DC28V at supply output
Programmable Relay Output (3)	1A DC28V at supply output
Programmable Relay Output (4)	1A DC28V at supply output
Case Dimension	135mm x 110mm x 44mm
Panel Cutout	116mm x 90mm
CT Secondary Current	5A rated
Working Conditions	Temperature: (-25~+70) $^{\circ}$ C; Relative Humidity: (20~93)%RH
Storage Condition	Temperature: (-25~+70) $^{\circ}$ C
Protection Level	IP65: rubber seal installed between the controller enclosure and panel fascia.
Insulating Intensity	Apply AC2.2kV voltage between high voltage terminal and low voltage terminal; The leakage current is not more than 3mA within 1min.
Net Weight	0.32kg

4 OPERATION

4.1 KEY FUNCTION

Table 3 - Key Function Descriptions

Icon	Function	Description
	Stop/ Reset	Stop running generator in Auto/Manual mode; In case of alarm condition, pressing the button will reset alarm; In stop mode, pressing and holding the button for 3 seconds will test indicator lights (lamp test); During stopping process, press this button again to stop generator immediately.
	Start	Under manual mode, press this button will start genset; press this button during genset start up, genset will jump to next status and genset can fast-boot.
	Manual	Pressing this key will set the module into manual mode.
	Auto	Pressing this key will set the module into auto mode.
	C/O	Pressing this key causes the controller to toggle the display C/O and the main page. Press Up or Down key to control switch close or open in C/O interface under manual mode.
	Set/Confirm	Pressing this key will enter into Main Menu; In setting parameter status, press this key will shift cursor or confirm setting value.
	Up/Increase	Scrolls the screen up; Shift the cursor up or increase the set value in parameter setting menu. In C/O interface under manual mode: press this button can control mains close or open(HGM4020 series); Press this button can control gen close (HGM4010 series).
	Down/Decrease	Scrolls the screen down; Shift the cursor down or decrease the set value in parameter setting menu. In C/O interface under manual mode: press this button can control gen close or open(HGM4020 series); Press this button can control gen open (HGM4010 series).



**4.2 CONTROLLER PANEL**



Fig.1 - HGM4010N/HGM4010NC/HGM4010CAN Front Panel Indication



Fig.2 - HGM4020N/HGM4020NC/HGM4020CAN Front Panel Indication

**NOTE: Part of indicator lights illustration:**

**Alarm Indicators:** slowly flash when warn alarms; fast flash when shutdown alarms; light is off when no alarms.

**Status Indicators:** Light is off when genset is standby; flash once per second during start up or shut down; always on when normal operation.

### 4.3 AUTO START/STOP OPERATION

Press , its indicator lights, and controller enters **Auto** mode.











#### Starting Sequence,

- 1) **HGM4020:** When Mains is abnormal (over and under voltage, loss of phase), it enters into mains “abnormal delay” and LCD display count down time. When mains abnormal delay is over, it enters into “start delay”.
- 2) **HGM4010:** Generator enters into “start delay” as soon as “Remote Start on Load” is active.
- 3) Start Delay timer is shown on LCD.
- 4) When start delay is over, preheat relay outputs (if this be configured), “preheat start delay XX s” is shown on LCD.
- 5) When preheat delay is over, fuel relay outputs 1s and then start relay output; if engine crank fails during “cranking time”, the fuel relay and start relay deactivated and enter into “crank rest time” to wait for next crank.
- 6) If engine crank fails within setting times, the fifth line of LCD turn black and Fail To Start message appears on fifth line of LCD display at the same time.
- 7) In case of successful crank attempt, “safety on timer” starts. During this period, low oil pressure, high water temperature, under speed, charge failure alarms and auxiliary inputs (if configured) are disabled. As soon as this delay is over, “start idle delay” is initiated (if configured).
- 8) During “start idle delay”, under speed, under frequency, under voltage alarms are inhibited. When this delay is over, “warming up delay” starts (if configured).
- 9) When “warming up delay” is over, if generator state is normal, its indicator will be illuminated. If voltage and frequency has reached on-load requirements, the closing relay will be energized, generator will accept load, generator power indicator will turn on, and generator will enter Normal Running state; if voltage and frequency are abnormal, the controller will initiate shutdown alarm (shutdown alarm will be displayed on LCD alarm page).



#### Stopping Sequence:

- 1) HGM4020, when mains return normal during gen-set running, enters into mains voltage “Normal delay”. After mains come to normal, mains status indicator is illuminate and “stop delay” initiated.
- 2) HGM4010, generator enters into “stop delay” as soon as “Remote Start on Load” is inactive.
- 3) When stop delay is over, close generator relay is un-energized; generator enters into “cooling down time”. After “transfer rest time”, close mains relay is energized. Mains on load and generator indicator extinguished while mains indicator lights.
- 4) Idle relay is energized as soon as entering “stop idle delay” (if configured).
- 5) If enter “ETS hold delay”, ETS relay is energized. Fuel relay is deactivated.
- 6) Then enter gen-set “Fail to stop time”, auto decides whether generator is stopped or not automatically.
- 7) Enter “generator at rest” as soon as “after stop time” is over. If genset fail to stop, controller will initiate alarms(fail to stop warning shown on LCD).

#### 4.4 MANUAL START/STOP OPERATION

- 1) **HGM4020:** Manual mode is selected by pressing the  button; a LED besides the button will illuminate to confirm the operation; press  button to start the genset, it can automatically judge crank success and accelerate to high speed running. If high temperature, low oil pressure, over speed and abnormal voltage occur during genset running, controller can effectively protect genset to stop (detail procedures please refer to No.4~9 of Auto start sequence). Under **Manual Mode**, load breaker won't transfer automatically and  C/O key should be pushed to enter into the C/O interface.  
  
Through  key to control mains switch open/close and  key to control generator switch open/close.
- 2) **HGM4010:** Manual mode is selected by pressing the  button; a LED besides the button will illuminate to confirm the operation; then press  button to start the generator, it can automatically judge crank success and accelerate to high speed running. If high temperature, low oil pressure, over speed and abnormal voltage occur during genset running, controller can effectively protect genset to stop (detail procedures please refer to No.4~9 of Auto start sequence). After genset high speed normal running, press the key  to enter into the Close/Open interface. Through  key to control generator switch close and  key to control generator switch open.
- 3) Manual stop: pressing  key can stop the running genset. (detail procedures please refer to No.3~7 of Auto stop sequence)

#### 4.5 EMERGENCY START UP

Simultaneously press  and  in manual mode will force generator to crank. Successful start will not be judged according to crank disconnect conditions, operator will have to crank the starter motor manually; when operator decides that the engine has fired, he/she should release the button and start output will be deactivated, safety on delay will be initiated.

## 5 PROTECTION

### 5.1 WARNINGS

When controllers detects the warning signals, alarm only and not stop the genset, besides, the LCD displays the warning information.

Table 4 - Warning Alarms Types

No.	Type	Description
1	High Temperature	When the controller detects that engine temperature has exceeded the pre-set value while shutdown is prohibited, or detects that the Aux. input high temperature while shutdown is prohibited, it will initiate a warning alarm and the corresponding alarm information will be displayed on LCD.
2	Low Oil Pressure	When the controller detects that the oil pressure has fallen below the pre-set value while shutdown is prohibited, or detects that the Aux. input low oil pressure while shutdown is prohibited, it will initiate a warning alarm and the corresponding alarm information will be displayed on LCD.
3	Gen Over Current	When the controller detects that the genset current has exceeded the pre-set value and the over current delay has expired, it will initiate a warning alarm and the corresponding alarm information will be displayed on LCD.
4	Fail To Stop	After "fail to stop" delay/ ETS delay has expired, if gen-set does not stop completely, it will initiate a warning alarm and the corresponding alarm information will be displayed on LCD.
5	Low Fuel Level	When the controller detects that the fuel level has fallen below the pre-set value while shutdown is prohibited, or detects that the Aux. input low fuel level while shutdown is prohibited, it will initiate a warning alarm and the corresponding alarm information will be displayed on LCD.
6	Charge Alt Failure	When the controller detects that charger voltage has fallen below the battery voltage and the difference value exceed pre-set charging voltage difference value, it will initiate a warning alarm and the corresponding alarm information will be displayed on LCD.
7	Battery Under Volt	When the controller detects that battery voltage has fallen below the pre-set value, it will initiate a warning alarm and the corresponding alarm information will be displayed on LCD.
8	Battery Over Volt	When the controller detects that battery voltage has exceeded the pre-set value, it will initiate a warning alarm and the corresponding alarm information will be displayed on LCD.
9	Auxiliary Input	When the controller detects that the auxiliary input warning signals, it will initiate a warning alarm and the corresponding alarm information will be displayed on LCD.
10	Loss Of Speed Signal	When the controller detects that the engine speed is 0 and the delay is 0, it will initiate a warning alarm and the corresponding alarm information will be displayed on LCD.



No.	Type	Description
11	Low Coolant Level	When the controller detects the low coolant level input is active, it will initiate a warning alarm and the corresponding alarm information will be displayed on LCD.
12	Temp. Sensor Open	When the controller detects that the temperature sensor is open circuit and the action select "Warn", it will initiate a warning alarm and the corresponding alarm information will be displayed on LCD.
13	Oil Pressure Sensor Open	When the controller detects that the oil pressure sensor is open circuit and the action select "Warn", it will initiate a warning alarm and the corresponding alarm information will be displayed on LCD.
14	Level Sensor Open	When the controller detects that the level sensor is open circuit and the action select "Warn", it will initiate a warning alarm and the corresponding alarm information will be displayed on LCD.
15	Temp. Sensor 2 Open	If the config. sensor set as temperature sensor, When the controller detects that the temperature sensor is open circuit and the action select "Warn", it will initiate a warning alarm and the corresponding alarm information will be displayed on LCD.
16	Oil Pressure Sensor 2 Open	If the config. sensor set as oil pressure sensor, When the controller detects that the oil pressure sensor is open circuit and the action select "Warn", it will initiate a warning alarm and the corresponding alarm information will be displayed on LCD.
17	Level Sensor 2 Open	If the config. sensor set as level sensor, When the controller detects that the level sensor is open circuit and the action select "Warn", it will initiate a warning alarm and the corresponding alarm information will be displayed on LCD.
18	High Temperature 2	When the controller detects that config. sensor temperature (sensor type: temperature sensor) has exceeded the pre-set value while shutdown is prohibited, it will initiate a warning alarm and the corresponding alarm information will be displayed on LCD.
19	Low Oil Pressure 2	When the controller detects that config. sensor oil pressure (sensor type: oil pressure sensor) has fallen below the pre-set value while shutdown is prohibited, it will initiate a warning alarm and the corresponding alarm information will be displayed on LCD.
20	Low Coolant Level	When the controller detects that config. sensor coolant level (sensor type: level sensor) has fallen below the pre-set value while shutdown is prohibited, it will initiate a warning alarm and the corresponding alarm information will be displayed on LCD.
21	Maintenance Due	When genset running time has exceeded the user setting maintenance time and the action select "Warn", it will initiate a warning alarm and the corresponding alarm information will be displayed on LCD. The maintenance alarm will reset if the action select "Inactive".
22	Gen Over Voltage	When controller detects the voltage is higher than the set value, it will send warn signals and the corresponding alarm information will be displayed on LCD.



No.	Type	Description
23	Gen Under Voltage	When controller detects the voltage is lower than the set value, it will send warn signals and the corresponding alarm information will be displayed on LCD.
24	Gen Over Frequency	When controller detects the frequency is higher than the set value, it will send warn signals and the corresponding alarm information will be displayed on LCD.
25	Gen Under Frequency	When controller detects the frequency is lower than the set value, it will send warn signals and the corresponding alarm information will be displayed on LCD.
26	Charge Alt Fail	When controller detects the charger alt fail warn input is active, it will send alarm signals and the corresponding alarm information will be displayed on LCD.
27	Over Power	When controller detects the power value (power is positive) is higher than the set value and the action select warn, it will send warn signals and the corresponding alarm information will be displayed on LCD.
28	ECU Warn	When controller gets the warn signals from engine via J1939, it will send warn signals and the corresponding alarm information will be displayed on LCD.

SmartGen

## 5.2 SHUTDOWN ALARM

When controller detects shutdown alarm, it will send signals to stop the generator and the corresponding alarm information will be displayed on LCD.

Table 5 - Shutdown Alarms

No.	Type	Description
1	Emergency Stop	When controller detects emergency stop signals, it will send stop signals and the corresponding alarm information will be displayed on LCD.
2	Over Speed	When controller detects the speed value is higher than the set value, it will send stop signals and the corresponding alarm information will be displayed on LCD.
3	Under Speed	When controller detects the speed value is lower than the set value, it will send stop signals and the corresponding alarm information will be displayed on LCD.
4	Loss Of Speed Signal	When controller detects speed value equals to 0, and delay value isn't 0 (action select "Shutdown"), it will send stop signals and the corresponding alarm information will be displayed on LCD.
5	Over Frequency	When controller detects the frequency value is higher than the set value, it will send stop signals and the corresponding alarm information will be displayed on LCD.
6	Under Frequency	When controller detects the frequency value is lower than the set value, it will send stop signals and the corresponding alarm information will be displayed on LCD.
7	Over Voltage	When controller detects the voltage value is higher than the set value, it will send stop signals and the corresponding alarm information will be displayed on LCD.
8	Under Voltage	When controller detects the voltage value is lower than the set value, it will send stop signals and the corresponding alarm information will be displayed on LCD.
9	Over Current	When controller detects the current value is higher than the set value and the delay value is not 0, it will send stop signals and the corresponding alarm information will be displayed on LCD.
10	Fail To Start	If genset start failure within setting of start times, controller will send stop signals and the corresponding alarm information will be displayed on LCD.
11	High Temp. Shutdown	When controller detects temperature of water/cylinder is higher than the set value, it will send stop signals and the corresponding alarm information will be displayed on LCD.



No.	Type	Description
12	Low Oil Pressure	When controller detects oil pressure is lower than the set value, it will send stop signals and the corresponding alarm information will be displayed on LCD.
13	No Generate Electricity	When controller detects frequency of genset is 0, it will send stop signals and the corresponding alarm information will be displayed on LCD.
14	Low Fuel Level	When controller detects fuel level value lower than the pre-set value or the low fuel level input is active, controller send stop signals and the corresponding alarm information will be displayed on LCD.
15	Low Coolant Level Alarm Shutdown	When controller detects low coolant level input is active, controller send stop signals and the corresponding alarm information will be displayed on LCD.
16	Temp. Sensor Open	When controller detects sensor, which connected to temperature sensor, is open circuit, and the action select "shutdown", it will send stop signals and the corresponding alarm information will be displayed on LCD.
17	Oil Pressure Sensor Open	When controller detects sensor, which connected to oil pressure sensor, is open circuit, and the action select "shutdown", it will send stop signals and the corresponding alarm information will be displayed on LCD.
18	Fuel Level Sensor Open	When controller detects sensor, which connected to fuel level sensor, is open circuit, and the action select "shutdown", it will send stop signals and the corresponding alarm information will be displayed on LCD.
19	Temp. Sensor 2 Open	When controller detects temp. sensor, which connected to programmable sensor, is open circuit, and the action select "shutdown", it will send stop signals and the corresponding alarm information will be displayed on LCD.
20	Pressure Sensor 2 Open	When controller detects pressure sensor, which connected to programmable sensor, is open circuit, and the action select "shutdown", it will send stop signals and the corresponding alarm information will be displayed on LCD.
21	Coolant Level Sensor Open	When controller detects liquid level sensor, which connected to programmable sensor, is open circuit, and the action select "shutdown", it will send stop signals and the corresponding alarm information will be displayed on LCD.
22	High Temp. 2 Shutdown	When controller detects the sample value, which adopted by the



No.	Type	Description
		programmable temperature sensor, is higher than the pre-set value, it will send stop signals and the corresponding alarm information will be displayed on LCD.
23	Low Pressure 2 Shutdown	When controller detects the sample value, which adopted by the programmable pressure sensor, is lower than the pre-set value, it will send stop signals and the corresponding alarm information will be displayed on LCD.
24	Low Coolant Level Shutdown	When controller detects the sample value, which adopted by the programmable liquid level sensor, is lower than the pre-set value, it will send stop signals and the corresponding alarm information will be displayed on LCD.
25	Maintenance Due	When genset operation time exceeds maintenance time that user pre-set and the action select "shutdown", it will send stop signals and the corresponding alarm information will be displayed on LCD.
26	Over Power Shutdown Alarm	When controller detects the power value (power is positive) is higher than the max. set value and the action select "shutdown", it will send stop signals and the corresponding alarm information will be displayed on LCD.
27	Digital Input Port Alarm Shutdown	When controller detects external active shutdown alarm signals, it will send stop signals and the corresponding alarm information will be displayed on LCD.
28	ECU Alarm Shutdown	After engine start, controller dos not receive data signals, via J1939, controller send stop signals.
29	ECU Fail to Communication	When controller detects the sensor value is higher than the max. set value, it will send stop signals.

**NOTE:** ECU warns and shutdown alarms illustration, if there are detailed alarms display, controller will check engine based on the content. Otherwise, please look up engine Manuel to get the information based on the SPN code.

## 6 WIRINGS CONNECTION

Compared with HGM4020, HGM4010 missing one mains voltage three-phase input terminal. HGM4020 controller back panel is as follows:

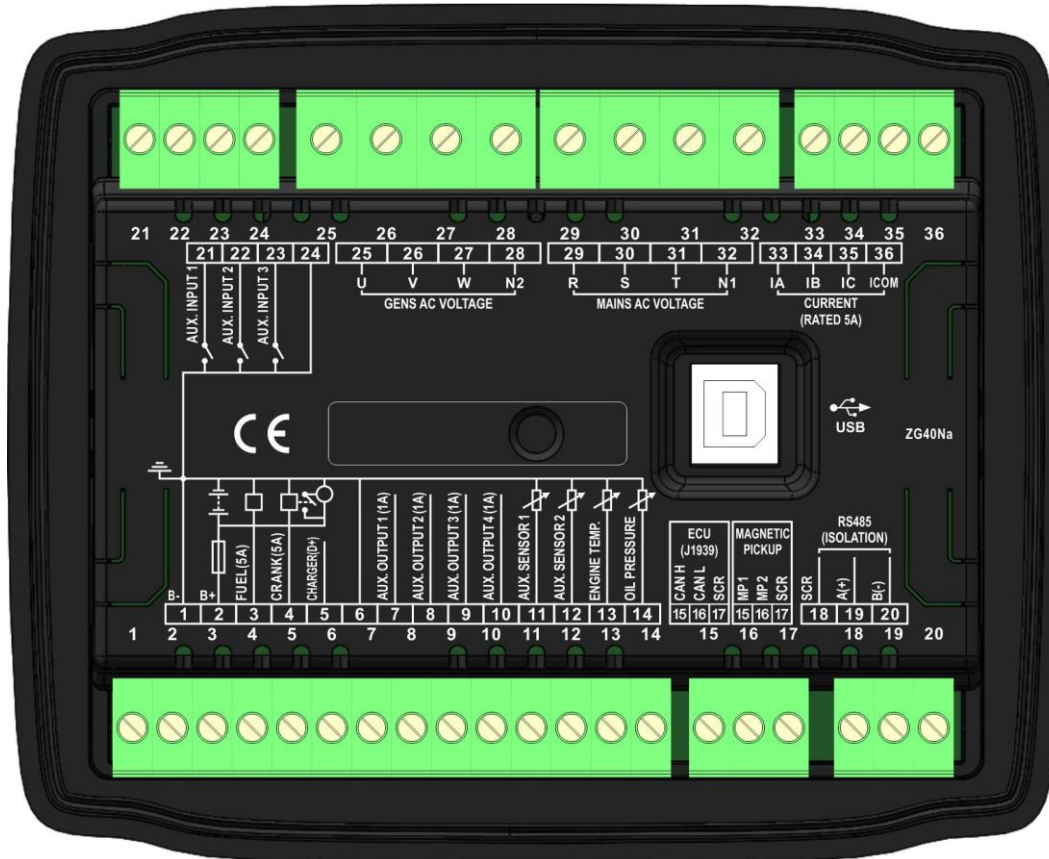

Fig.3 - HGM4020 Back Panel

Table 6 - Terminal Wiring Connection

No.	Function	Cable Size	Remarks
1	B-	2.5mm <sup>2</sup>	Connected with negative of starter battery
2	B+	2.5mm <sup>2</sup>	Connected with positive of starter battery. If wire length is over 30m, better to double wires in parallel. Max. 20A fuse is recommended.
3	Fuel relay output	1.5mm <sup>2</sup>	B+ is supplied by 2 terminal, rated 5A Parameter set as “programmable relay output 5”.
4	Start relay output	1.5mm <sup>2</sup>	B+ is supplied by 2 terminal, rated 5A
5	Charger(D+)	1.0mm <sup>2</sup>	Connected with charger starter’s D+ (WL) terminals. Being hang up If there is no this terminal.
6	Common earth ground	1.5 mm <sup>2</sup>	Inside connect to B-.
7	Aux. Output 1	1.0mm <sup>2</sup>	B+ is supplied by 2 terminal, rated 1A
8	Aux. Output 2	1.0mm <sup>2</sup>	B+ is supplied by 2 terminal, rated 1A

Details see Table 8



No.	Function		Cable Size	Remarks	
9	Aux. Output 3		1.0mm <sup>2</sup>	B+ is supplied by 2 terminal, rated 1A	
10	Aux. Output 4		1.0 mm <sup>2</sup>	B+ is supplied by 2 terminal, rated 1A	
11	Aux. Input 1		1.0mm <sup>2</sup>	Used as liquid level sensor or digital input port 4	
12	Aux. Input 2		1.0mm <sup>2</sup>	Used as programmable sensor or digital input port 5	
13	Temperature sensor		1.0mm <sup>2</sup>	Connected with water temperature or cylinder temperature resistor type sensor.	Details see Table 10
14	Oil pressure sensor		1.0mm <sup>2</sup>	Connected with oil pressure resistor type sensor.	
15	CAN H	Speed sensor input	0.5mm <sup>2</sup>	Controller connected with CAN BUS(if with CAN BUS function); Controller connected with speed sensor(if with no CAN BUS function); Shielding line is recommended.	
16	CAN L	Speed sensor input. Controller inside connected with battery cathode	0.5mm <sup>2</sup>		
17	CAN Common ground		0.5mm <sup>2</sup>		
18	RS485 Common ground		/	Impedance-120Ω shielding wire is recommended, its single-end earthed	
19	RS485A(+)		0.5mm <sup>2</sup>		
20	RS485B(-)		0.5mm <sup>2</sup>		
21	Aux. input 1		1.0mm <sup>2</sup>	Ground connected is active (B-)	Details see Table 9
22	Aux. input 2		1.0mm <sup>2</sup>	Ground connected is active (B-)	
23	Aux. input 3		1.0mm <sup>2</sup>	Ground connected is active (B-)	
24	Input COM		1.0mm <sup>2</sup>	Inside connected to B-	
25	Genset U-phase voltage monitoring input		1.0mm <sup>2</sup>	Connected to U-phase output of genset (2A fuse recommended).	
26	Genset V-phase voltage monitoring input		1.0mm <sup>2</sup>	Connected to V-phase output of genset (2A fuse recommended).	
27	Genset W-phase voltage monitoring input		1.0mm <sup>2</sup>	Connected to W-phase output of genset (2A fuse recommended).	
28	Genset line N2 input		1.0mm <sup>2</sup>	Connected to N-line output of genset.	
29	Mains R-phase voltage monitoring input		1.0mm <sup>2</sup>	Connected to R-phase of mains (2A fuse recommended). (HGM4010 without)	
30	Mains S-phase voltage monitoring input		1.0mm <sup>2</sup>	Connected to S-phase of mains (2A fuse recommended). (HGM4010 without)	



No.	Function	Cable Size	Remarks
31	Mains T-phase voltage monitoring input	1.0mm <sup>2</sup>	Connected to T-phase of mains (2A fuse recommended). (HGM4010 without)
32	Mains line N1 Input	1.0mm <sup>2</sup>	Connected to line N of mains (HGM4010 without)
33	CT A-phase monitoring input	1.5mm <sup>2</sup>	Outside connected to secondary coil of CT (5A rated).
34	CT B-phase monitoring input	1.5mm <sup>2</sup>	Outside connected to secondary coil of CT (5A rated).
35	CT C-phase monitoring input	1.5mm <sup>2</sup>	Outside connected to secondary coil of CT (5A rated).
36	CT COM	1.5mm <sup>2</sup>	Reference to <i>Installation Instruction</i>

**NOTE:** USB ports in controller rear panel are programmable parameter ports, user can directly configure controller via PC.



## 7 SCOPES AND DEFINITIONS OF PROGRAMMABLE PARAMETERS

### 7.1 CONTENTS AND SCOPES OF PARAMETERS

Table 7 - Parameters Settings and Scope

No	Items	Range	Default	Description
1	Mains Normal Delay	(0-3600)s	10	The time from mains abnormal to normal or from normal to abnormal; suitable for ATS (automatic transfer switch).
2	Mains Abnormal Delay	(0-3600)s	5	
3	Mains Under Voltage Value	(30-620)V	184	When mains voltage has fallen below the set value, Mains Under Voltage is active. When set the value as 30V, the controller does not detect under voltage signal. Back lash: 10V
4	Mains Over Voltage Value	(30-620)V	276	When mains voltage has exceeded the set value, Mains Over Voltage is active. When set the value as 620V, the controller does not detect over voltage signal. Back lash: 10V
5	Switch Transfer Delay	(0-99.9)s	1.0	Interval time from mains switch off to generator switch on; or from generator switch off to mains switch on.
6	Start Delay	(0-3600)s	1	Time from mains abnormal or remote start signal is active to start genset.
7	Stop Delay	(0-3600)s	1	Time from mains normal or remote start signal is deactivated to genset stop.
8	Start Attempts	(1-10)times	3	Maximum crank times of crank attempts. When reach this number, controller will send start failure signal.
9	Preheat Delay	(0-300)s	0	Power-on time of heater plug before starter is powered up.
10	Cranking Time	(3-60)s	8	Power-on time of starter
11	Crank Rest Time	(3-60)s	10	The waiting time before second power up when engine start fail.
12	Safety On Delay	(1-60)s	10	Alarms for low oil pressure, high temperature, under speed, under frequency/voltage, charge alt failure are inactive.
13	Start Idle Time	(0-3600)s	0	Idle running time of genset when starting.
14	Warming Up Time	(0-3600)s	10	Warming time between genset switch on and high speed running.
15	Cooling Time	(3-3600)s	10	Radiating time before genset stop, after it unloads.
16	Stop Idle Time	(0-3600)s	0	Idle running time when genset stop.
17	ETS Solenoid Hold	(0-120)s	20	Stop electromagnet's power on time when genset is stopping.
18	Fail to Stop Delay	(0-120)s	5	Time between ending of genset idle delay and stopped when "ETS time" is set as 0;



No	Items	Range	Default	Description
				Time between ending of ETS hold delay and stopped when “ETS time” is not 0.
19	Switch Close Time	(0-10)s	5.0	Pulse width of mains/generator switch on. When it is 0, means output constantly.
20	Flywheel Teeth	(10.0-300.0)	118.0	Tooth number of the engine, for judging of starter crank disconnect conditions and inspecting of engine speed. See the installation instructions.
21	Gen Abnormal Delay	(0-20.0)s	10.0	The alarm delay of generator over voltage and under voltage.
22	Gen Over Voltage Shutdown	(30-620)V	276	When generator voltage has exceeded the set value and the “Gen abnormal delay” has expired, Gen Over Voltage is active. When set the value as 620V, the controller does not detect over voltage signal.
23	Generator Under Voltage Shutdown	(30-620)V	184	When generator voltage has fallen below the set value and the “Gen abnormal delay” has expired, Gen Under Voltage is active. When set the value as 30V, the controller does not detect under voltage signal.
24	Engine Under Speed Shutdown	(0-6000)RPM	1200	When engine speed has fallen below the set value for 10s, Under Speed is active. It will initiate a shutdown alarm signal.
25	Engine Over Speed Shutdown	(0-6000)RPM	1710	When engine speed has exceeded the set value for 2s, Over Speed is active. It will initiate a shutdown alarm signal.
26	Gen Under Frequency	(0-75.0)Hz	40.0	When generator frequency has fallen below the set value but Not equal to 0 for 10s, Under Frequency is active. It will initiate a shutdown alarm signal.
27	Gen Over Frequency	(0-75.0)Hz	57.0	When generator frequency has exceeded the set value for 2s, Over Frequency is active. It will initiate a shutdown alarm signal.
28	High Temperature Shutdown	(80-300)°C	98	When the temperature value of the external temperature sensor exceeds the set value, “High Temperature” timer is initiated. Detecting only after safety on delay has expired. If the set value is 300, high temperature signal will not be sent (this only concerns external temperature sensor, not high temperature signal via config. input port).
29	Low Oil Pressure Shutdown	(0-400)kPa	103	When the external pressure sensor value falls below this set value, “Low Oil Pressure” timer is initiated. Detecting



No	Items	Range	Default	Description
				only after safety on delay has expired. If the set value is 0, low oil pressure signal will not be sent (this only concerns pressure sensor and does not concern low oil pressure warning signal via configurable input port)
30	Low Fuel Level Value	(0-100)%	10	When the liquid level of the external sensor falls below the set value for 10s, "Low Fuel Level" signal is initiated. This action only warning and not to shutdown the generator.
31	Flexible Sensor Values	(80-140)°C (0-400)kPa (0-100)%	98	Each value correspond to above 28 (Temperature sensor), 29 (Oil pressure sensor) and 30 (Level sensor), respectively.
32	Loss of Speed Signal	(0-20.0)s	5.0	If the set value is 0s, only warning and not to shutdown the generator.
33	Voltage Difference of Charge Alt Failure	(0-30)V	6.0	During generator is normal running, when voltage difference between alternator D+(WL) and B+ exceeds the set value and remains for 5s, It will initiate a charge alt failure shutdown alarm signal.
34	Battery Over Voltage	(12-40)V	33.0	When battery voltage has exceeds the set value and remains for 20s, It will initiate a warning alarm signal. Only warning and not to shutdown the generator.
35	Battery Under Voltage	(4-30)V	8.0	When battery voltage has fallen below the set value and remains for 20s, It will initiate a warning alarm signal. Only warning and not to shutdown the generator.
36	Current Transform	(5-6000)/5	500	The ratio of external CT
37	Full Load Rating	(5-6000)A	500	Generator's rated current, used for load over current calculating.
38	Over Current Percentage	(50-130)%	120	When the load current has exceeded the set value, "over current" delay is initiated.
39	Over Current Delay	(0-3600)s	30	When load current has exceeded the set value and the "over current" delay has expired, over current alarm is initiated. When the set value is 0, only warning and not to shutdown the generator.
40	Fuel Pump On	(0-100)%	25	When fuel level has fallen below the set value for 10s, "Fuel Pump On" alarm is initiated.
41	Fuel Pump Off	(0-100)%	80	When fuel level has exceeded the set value for 10s, "Fuel Pump Off" alarm is initiated.

No	Items	Range	Default	Description
42	Relay Output 1	(0-31)	6	Factory default: Mains Closed. Detail to see <a href="#">Table 8</a>
43	Relay Output 2	(0-31)	2	Factory default: Energized To Stop Detail to see <a href="#">Table 8</a>
44	Relay Output 3	(0-31)	3	Factory default: Idle Control Detail to see <a href="#">Table 8</a>
45	Relay Output 4	(0-31)	5	Factory default: Close Generator Detail to see <a href="#">Table 8</a>
46	Relay Output 5	(0-31)	14	Factory default: Fuel relay output Detail to see <a href="#">Table 8</a>
47	Digital Input 1	(0-31)	1	Factory default: High Temperature Input Detail to see <a href="#">Table 8</a>
48	Digital Input 1 Active	(0-1)	0	Factory default: Close to active
49	Digital Input 1 Delay	(0-20.0)s	2.0	
50	Digital Input 2	(0-31)	2	Factory default: Low Oil Pressure Warn Input. Detail to see <a href="#">Table 9</a>
51	Digital Input 2 Active	(0-1)	0	Factory default: Close to active
52	Digital Input 2 Delay	(0-20.0)s	2.0	
53	Digital Input 3	(0-31)	10	Factory default: Remote Start Detail to see <a href="#">Table 9</a>
54	Digital Input 3 Active	(0-1)	0	Factory default: Close to active
55	Digital Input 3 Delay	(0-20.0)s	2.0	
56	Digital Input 4	(0-31)	11	Factory default: Low Fuel Level Warn Input. Detail to see <a href="#">Table 9</a>
57	Digital Input 4 Active	(0-1)	0	Factory default: Close to active
58	Digital Input 4 Delay	(0-20.0)s	2.0	
59	Digital Input 5	(0-31)	12	Factory default: Low Coolant Level Warn Input. Detail to see <a href="#">Table 9</a>
60	Digital Input 5 Active	(0-1)	0	Factory default: Close to active
61	Digital Input 5 Delay	(0-20.0)s	2.0	
62	Power On Mode	(0-2)	0	0: Stop Mode 1: Manual Mode 2: Auto Mode
63	Module Address	(1-254)	1	Communication address of controller.
64	Password	(0-9999)	0318	Detail to see <a href="#">NOTE 6</a>
65	Crank Disconnect	(0-6)	2	There are 3 conditions of disconnecting starter with engine: Generate electricity, Speed and Oil Pressure. Aiming at to separating the start motor and genset as soon as possible.
66	Engine Speed of Crank Disconnected	(0-6000)r/min	360	When engine speed higher than the set value, starter will be disconnected.
67	Generator Freq of Crank Disconnected	(10.0-30.0)Hz	14.0	When generator frequency higher than the set value, starter will be disconnected.
68	Oil Pressure of Crank Disconnected	(0-400)kPa	200	When generator oil pressure higher than the set value, starter will be





No	Items	Range	Default	Description
				disconnected.
69	High Temperature Inhibit	(0-1)	0	Factory default: when high temperature occurs, shutdown alarm is initiated. Detail to see <a href="#">NOTE 2</a>
70	Low Oil Pressure Inhibit	(0-1)	0	Factory default: when low oil pressure occurs, shutdown alarm is initiated. Detail to see <a href="#">NOTE 3</a>
71	Low Fuel Level Inhibit	(0-1)	1	Factory default: when low fuel level occurs, shutdown alarm is initiated. Detail to see <a href="#">NOTE 4</a>
72	Flexible Sensor Inhibit	(0-1)	1	Factory default: when config. sensor value higher/lower than the set value (particular case depends on the sensor type), shutdown alarm is initiated. Detail to see <a href="#">69,70,71 Setting Items</a>
73	AC System	(0-3)	0	0: 3P4W; 1: 2P3W 2: 1P2W; 3: 3P3W
74	Temp. Sensor Curve	(0-12)	8	SGX Detail to see <a href="#">Table 10</a>
75	Pressure Sensor Curve	(0-12)	8	SGX Detail to see <a href="#">Table 10</a>
76	Multiplex Input Liquid Level Sensor	(0-1)	0	0: Aux. Input 4 Configuration 1: Liquid Level Sensor Detail to see <a href="#">NOTE 5</a>
77	Level Sensor Curve	(0-7)	3	SGD Detail to see <a href="#">Table 10</a>
78	Multiplex Input Programmable Sensor	(0-3)	0	0: Aux. Input 5 Configuration 1: Temperature Sensor 2: Pressure Sensor 3: Liquid Level Sensor Detail to see <a href="#">NOTE 5</a>
79	Flexible Sensor Curve	(0-9)	8	SGX
		(0-9)	8	SGX
		(0-5)	3	SGD
80	Poles	(2-64)	4	Numbers of generator poles, which can be used to calculate generator speed (generator with no speed sensor).
81	Temp. Sensor Open Circuit Action	(0-2)	1	0: Indication (temperature sensor will show “+++”); 1:Warn; 2:Shutdown
82	Oil Pressure Sensor Open Circuit Action	(0-2)	1	
83	Level Sensor Open Circuit Action	(0-2)	1	
84	Flexible Sensor Open Circuit Action	(0-2)	1	
85	Cooler On Set Value	(0-255)°C	60	It controls the cooling blower to open or close if the output port is configured as Cooling Blower.
86	Cooler Off Set Value	(0-255)°C	40	
87	Low Fuel Level	(0-100)%	20	When the liquid level of the external



No	Items	Range	Default	Description
	Warning			sensor falls below the set value, "Low Fuel Level" timer is initiated. (this only concerns fuel level sensor and does not concern low fuel level warning signal via configurable input port)
88	Gen Over Volt Warning	(30-620)V	253	When generator voltage exceeds pre-set value, gen over voltage warning alarm will be sent. (No detection for over volt signal if the value set as 620V)
89	Gen Under Volt Warning	(30-620)V	193	When generator voltage below pre-set value, gen under voltage warning alarm will be sent. (No detection for under volt signal if the value set as 30V)
90	Gen Over Freq Warning	(0-75.0)Hz	55.0	When generator frequency exceeds the pre-set value, gen over frequency warning signals will be sent.
91	Gen Under Freq Warning	(0-75.0)Hz	42.0	When generator frequency below the pre-set value, gen under frequency warning signals will be sent.
92	Gen Over Current Protection Warning	(50-130)%	110	When generator current exceeds the pre-set value, gen over current warning signals will be sent. (No warning alarms been sent if the value set as 0)
93	High Water Temp. Warning	(80-300)°C	95	When the value of external temperature sensor exceeds the pre-set value, which only be functional for external temp. sensor after safety delay, over high temp. signals will be sent. No warning alarms been sent if the value set as 300 (only suit for temp. sensor, and digital inputs are not included).
94	Low Oil Pressure Warning	(0-400)kPa	124	When the value of external pressure sensor below the pre-set value, which only be functional after safety delay, low oil pressure delay timer will be initiated. No warning alarms been sent if the value set as 0 (only suit for pressure sensor, and digital inputs are not included).
95	Flexible Sensor Warning	(80-300)°C (0-400)kPa (0-100)%	95	Respectively correspond to 93(Temperature Sensor set), 94(Pressure Sensor set), 87(Level Sensor set) in this table.
96	Gen Over Volt Delay	(0-20.0)s	10.0	When generator volt higher than the pre-set shutdown value and the "over volt" delay has expired, then it can be considered as gen over volt shutdown.
97	Gen Over Frequency Delay	(0-20.0)s	2.0	When generator frequency higher than the pre-set shutdown value and the "over frequency" delay has expired, then it can



No	Items	Range	Default	Description
				be considered as gen over frequency shutdown.
98	Oil Pressure Delay of Crank Disconnected	(0-20.0)s	0.0s	When crank disconnected condition includes oil pressure, oil pressure of engine exceeds the preset crank disconnected value and the delay has expired, then it can be considered as genset start successfully and starter will be disconnected.
99	Scheduled Run Set	(0-1) (0-1)	0 0	0: Enabled inhibit 1: Enabled 0: Off load 1: On load
100	Cycle Scheduled Run Set	(0-2) (1-31) (0-7) (1-23)h (1-59)min (0-30000)min	0 1 0 0 0 30	Cycle options: 0:monthly 1:Weekly 2:Daily Day(Cycle options: 0: monthly active) Week(Cycle options: 0: weekly active) Prohibit start time(hour) Prohibit start time(minute) Duration time
101	Auto Start Inhibit Set	(0-1)	0	0: Enabled disabled 1: Enabled
102	Cycle Auto Start Inhibit Set	(0-2) (1-31) (0-7) (1-23)h (1-59)min (0-30000)min	0 1 0 0 0 30	Cycle options: 0:monthly 1:Weekly 2:Daily Day(Cycle options: 0: monthly active) Week(Cycle options: 0: weekly active) Prohibit start time(hour) Prohibit start time(minute) Duration time
103	Overload Protection	(0-2) (0-6000)kW (0-6000)kW (0-3600)s	0 304 290 5	0: Not used 1: Warn 2: Shutdown Overload set value Overload warn return value Overload delay value When power value exceeds preset value and delay has expired, over power is active. Both return value and delay value can be set.
104	Date Set	Set up controller's date.		
105	Custom Sensor Curve Input	(0-3)	0	0: Custom temperature sensor 1: Custom pressure sensor 2: Custom fuel level sensor 3: Custom flexible sensor Choose sensor and input every point resistance value or corresponding value of sensor curve. (8 points need to be input)
106	Engine Type	(0-39)	0	Conventional genset
107	SPN Alarm Version	(1-3)	1	Alarm Version 1
108	Manual Close Enable Selection	(0-1)	1	0: Disabled; 1: Enabled; When enabled, switch by pressing button; when disabled, switch automatically.
109	Raise Speed Pulse Time	(0-20.0)s	0.2	It is output when genset enters into warming up period.

No	Items	Range	Default	Description
110	Drop Speed Pulse Time	(0-20.0)s	0.2	It is output when genset enters into stop idling period.

**▲NOTE:**

- 1) Parameter serial number defaults to HGM4020's. Compared with HGM4020, HGM4010 parameter serial number missing top 5 items, which means corresponding serial number minus 5 is HGM4010's.
- 2) If the parameter configured as High Temperature Stop Inhibit or configured digital input port as High Temperature Stop Inhibit (input port is active), controller only send high temperature alarm signals instead of shutdown signals when temperature value is higher than the preset value or high temperature stop signals is active.
- 3) If the parameter configured as Low Oil Pressure Stop Inhibit or configured digital input port as Low Oil Pressure Stop Inhibit (input port is active), controller only send low oil pressure alarm signals instead of shutdown signals when oil pressure value is lower than the preset value or low oil pressure stop signals is active.
- 4) If the parameter configured as Low Fuel Level Stop Inhibit or configured digital input port as Low Fuel Level Stop Inhibit (input port is active), controller only send low fuel level alarm signals instead of shutdown signals when fuel level value is lower than the preset value or low fuel level stop signals is active.
- 5) Multiplex input port configured as either digital value or sensor, the corresponding items are active. E.g. if configured multiplex input port 4 as digital input port, the corresponding digital input port 4 items are active; if configured multiplex input port 4 as liquid level sensor, the corresponding liquid level sensor items are active.
- 6) When doing parameter configuration via PC software, there is no need to input password if default password (0318) isn't change; otherwise, if default password been changed or first time to set parameters via PC, password need to be wrote into the password interface.
- 7) After the correct password is entered, Parameter setting interface can be entered directly by inputting parameter serial when secondary entering the password interface before LCD backlight darken.
- 8) Engine teeth configuration: press start button when generator frequency exceeds 20Hz. Engine teeth number will be calculated automatically and press conform button can change the number of engine teeth.

## 7.2 ENABLE DEFINITION OF PROGRAMMABLE OUTPUT PORTS

Table 8 Enable Programmable Output Ports 1~5

No	Items	Description
0	Not Used	Output port is deactivated when "Not Used" is selected.
1	Common Alarm	Include all shutdown alarms and warning alarms. When there is warning alarm only, it is not self-lock; when a shutdown alarm occurs, it is self-lock until the alarm is reset.
2	Energize to Stop	Suitable for genset with electromagnet and will active after "stop idle delay". It is deactivated when the "ETS Solenoid delay" expires.
3	Idle Control	Used for engine which has idles. Close before starting and open in warming up delay; Close during stop idle delay and open when stop is completed.
4	Preheat Control	Close before starting and open before power up;
5	Close Generator Output	When close time is 0, it's continuous output.
6	Close Mains Output	<b>HGM4010</b> without this function.
7	Open ATS	When close time is 0, it's disabled.
8	Raise Speed Control	Close when the generator enters into Warming Up delay (close time: warming up delay) while open when Aux.
9	Drop Speed Control	Close when the generator enters into Stop Idle delay/ Energized to Stop delay (close time: Stop Idle delay) while open when Aux.
10	Generator Run Output	Action when genset is normal running while deactivated when engine speed is lower than the "crank disconnect speed".
11	Fuel Pump Control	Close when fuel level is lower than the "Fuel Pump On" value or when low fuel level warning input is active; Open when fuel level is higher than the "Fuel Pump Off" and low fuel level warning input is deactivated;
12	High Speed Control	Close when the generator enters into Warming Up delay while open after cooling delay.
13	In Auto Mode	The controller is in automatic mode.
14	Fuel Relay Output	Action when generator start; disconnect when wait for stop.
15	Excite Generator	Output in start period. If there is no generator frequency during safety running, output for 2 seconds.
16	Cooler Output	Control air cooler to start/stop according to cooler temperature.
17	Louver Control	Action in genset starting and disconnect when genset stopped completely.
18	Shutdown Alarm Output	Output when shutdown alarms appeared.
19	Audible Alarm	When warning and shutdown alarms appear, audible alarm output is fixed as 300s. When "alarm mute" or any keys on the panel configurable input port is active, it can remove the alarm.
20	Heater Control	Controlled by the upper or lower limit of temperature sensor.
21	Reserved	
22	Fuel Relay	Output when in start status; disconnected in other status.



No	Items	Description
23	ECU Stop	Used for ECU engine and control its stop.
24	ECU Power	Used for ECU engine and control its power.
25	ECU Warning	Indicate ECU sends a warning signal.
26	ECU Shutdown	Indicate ECU sends a shutdown signal.
27	ECU Communication Fail	Indicate controller not communicates with ECU.
28	Speed Raise Pulse	It is speed rise time when genset enters into hi-speed warming up period.
29	Speed Drop Pulse	It is speed drop time when genset enters into hi-speed warming up period.
30	Reserved	
31	Reserved	

### 7.3 DEFINED CONTENTS OF CONFIGURABLE INPUT PORTS

Table 9 Enable Programmable Inputs 1~5

No	Items	Description
0	Not Used	
1	High Temperature Shutdown	If these signals are active after safety on delay, shutdown alarm will be immediately initiated.
2	Low Oil Pressure Shutdown	
3	Warning Input	Only warning and not stops if this input is active.
4	Emergency Stop	Shutdown alarm will be immediately initiated if this input is active.
5	Water Temp. High Stop by Cool	When the gen-set is running normally and this signal is activated, if there is a high temperature situation, the controller will first cool down the generator and then stop it; if the signal is deactivated and a high temperature situation occurs, the controller will shut down the gen-set without cooling down.
6	Generator Closed Auxiliary	Connected to the auxiliary switch of the generator on load.
7	Mains Closed Auxiliary	Connected to the auxiliary switch of the mains on load.
8	Inhibit Water Temp. High Stop	When it is active, prohibit stopping when high temperature occurs. Details to see <u>NOTE 2</u>
9	Inhibit Oil Pressure Low Stop	When it is active, prohibit stopping when low oil pressure occurs. Details to see <u>NOTE 3</u>
10	Remote Start	When this input is active in auto mode, genset start automatically and on load after running. Otherwise, genset will stop automatically if it is inactive.
11	Fuel Level Warning	Connected to digital input port of sensor, if this input is active, controller will send warn alarm signal.
12	Coolant Level Warning	
13	Fuel Level Shutdown	Connected to digital input port of sensor, if this input is active, controller will send shutdown alarm signal.
14	Coolant Level Shutdown	



No	Items	Description
15	Inhibit Start Auto	In Auto mode, if this input is active, whether mains is normal or not, the controller will not give a start command to the generator. If generator is normal running, stop command won't be executed. When this input is deactivated, genset will automatically start or stop according to the mains status (normal or abnormal).
16	Remote Control	When the input is active, keys on the panel are locked except for    keys and remote mode will display on the LCD. Remote module pattern and start/stop operation can be switched by the keys on the panel.
17	Charge Alt Fail Input	Connected to charge alt failure output port.
18	Panel Lock	When input is active, all keys except the    buttons are inactive.
19	Manual/Auto Switch	When input is active, enter into auto mode automatically, panel buttons and local operation are inactive; When input is inactive, enter into manual mode automatically, remote operation is inhibited.
20	Alarm Mute	When input is active, "Audible Alarm" output can be inhibited.
21	Idle Input	Idle control output when input is active.
22	Raise Speed Pulse	Used for genset with CANBUS interface.
23	Drop Speed Pulse	Used for genset with CANBUS interface.
24	Idle Pulse Input	Used for genset with CANBUS interface.
25	60Hz Select	Used for genset with CANBUS interface. When it is active, frequency is 60Hz.
26	Shutdown Input	Genset will warn and shutdown immediately if the signal is active.
27	Reserved	
28	Reserved	
29	Reserved	
30	Reserved	
31	Reserved	

#### 7.4 SELECTION OF SENSORS

Table 10 Sensors Selection

No.	Description	Remark
1	Temperature Sensor	<ul style="list-style-type: none"> <li>0 Not used</li> <li>1 User Configured (Resistor type Curve)</li> <li>2 VDO</li> <li>3 SGH</li> <li>4 SGD</li> <li>5 CURTIS</li> <li>6 DATCON</li> <li>7 VOLVO-EC</li> <li>8 SGX</li> <li>9 Reserved</li> <li>10 Reserved</li> </ul> <p>Defined resistance's range is 0Ω-999.9Ω, default is SGX sensor.</p>

No.		Description	Remark
		11 Digital Closed 12 Digital Open	
2	Pressure Sensor	0 Not used 1 User Configured (Resistor type Curve) 2 VDO 10Bar 3 SGH 4 SGD 5 CURTIS 6 DATCON 10Bar 7 VOLVO-EC 8 SGX 9 Reserved 10 Reserved 11 Digital Closed 12 Digital Open	Defined resistance's range is 0Ω-999.9Ω, default is SGX sensor.
3	Oil Level Sensor	0 Not used 1 User Configured (Resistor type Curve) 2 SGH 3 SGD 4 reserved 5 reserved 6 Digital Closed 7 Digital Open	Defined resistance's range is 0Ω-999.9Ω, default is SGD sensor.

## 7.5 CONDITIONS OF CRANK DISCONNECT SELECTION

Table 11 Crank Disconnect Conditions Selection

No.	Setting description
0	Speed
1	Gen frequency
2	Speed + Gen frequency
3	Speed +Oil pressure
4	Gen frequency + Oil pressure
5	Speed + Gen frequency + Oil pressure
6	Oil pressure

### ▲NOTE:

- 1) There are 3 conditions to make starter separate with engine; speed, generator frequency and oil pressure can be used separately while oil pressure suggest be used together with speed and generator frequency. The aim is to disconnect the starter motor as soon as possible.
- 2) Speed stands for the real rotation speed detected by the speed sensor. Speed sensor is the magnetic equipment which be installed in starter for detecting flywheel teeth.
- 3) When set as speed, must ensure that the number of flywheel teeth is as same as setting, otherwise, "over speed shutdown" or "under speed shutdown" may be caused.
- 4) If genset without speed sensor please don't select corresponding items, otherwise, "start fail" or "loss speed signal" maybe caused.



- 5) If genset without oil pressure sensor, please don't select corresponding items.
- 6) If not select generator frequency in crank disconnect setting, controller will not collect and display the relative power quantity (can be used in water pump set); if not select speed in crank disconnect setting, the engine speed displayed in controller is calculated by generator signal.

## 8 PARAMETERS SETTING

### 8.1 CONTROLLER PARAMETER SETTING

Start the controller, then press  to enter into the parameters setting menu, menu items as follows:

- 1 Set Parameters
- 2 Information
- 3 Language
- 4 Eventlog
- 5 Maintenance

When entered password interface, inputting "0318" can set all parameter items in [Table 7](#). If the password is changed, only input the password same as controllers', can the parameter be set via PC software. If there is need to set more parameters (e.g. voltage calibration; current calibration), please contact the factory.

#### **NOTES:**





- a) For HGM4010, there are no items from 1 to 5 in [Table 7](#); there are no mains items in auxiliary output 1-5.
- b) Please change the controller parameters when generator is in standby mode only (e. g. Crank disconnect conditions selection, auxiliary input, auxiliary output, various delay), otherwise, shutdown and other abnormal conditions may occurs.
- c) Over voltage set value must be higher than under voltage set value, otherwise over voltage and under voltage condition may occur simultaneously.
- d) Over speed set value must be higher than under speed set value, otherwise over speed and under speed condition may occur simultaneously.
- e) Please set the generator frequency value as low as possible when cranking, in order to make the starter be separated quickly as soon as possible.
- f) Auxiliary input 1~5 could not be set as same items; otherwise, there are abnormal functions. However, the auxiliary output 1~5 can be set as same items.
- g) Programmable sensor 1 input port can be set as fuel level sensor or digital input port 4; programmable sensor 2 input port can be set as temperature sensor, pressure sensor, coolant level sensor or digital input port 5. Choose either sensor or digital input port, if digital input port be selected, corresponding set parameters be functional and sensor parameters are inactive and reserved; otherwise, if sensor be selected, corresponding sensor parameters be functional and digital input port parameters are deactive and reserved.
- h) If need to shut down after cooling, please set any auxiliary input as "High Temperature Stop Input", then connect this input port to GND or set "High Temperature Stop Input" action as "Cooling Stop"

## 8.2 CONTROLLER INFORMATION

- a) LCD will display software version, issue date of the controller.

**▲Note:** In this interface, press  will display the auxiliary inputs and outputs status.

- b) LCD contrast control

Press  and  or  and  simultaneously to adjust LCD contrast ratio and make LCD character display more clearly. Contrast ratio adjustment range: 0-7.

## 8.3 LANGUAGE SELECTION

Chinese, English, Spanish, Russian, Turkish, French, Portuguese and Polish can be optional.

## 8.4 EVENT LOG

View event log from this interface, including start/stop information and shutdown alarm information log. It can record and display up to 99 pieces.

## 8.5 MAINTENANCE

Password need to be input when enter into the maintenance interface, default as 0(if change this password, please contact with SmartGen service personnel or sales personnel). Setting maintenance parameters will refresh maintenance time.

**▲Note:** Refresh maintenance time and enter into the next maintenance period in maintenance interface when Maintenance Due Alarm.

## 9 SENSOR SETTING

- When reselect sensors, the sensor curve will be transferred into the standard value. For example, if temperature sensor is SGH (120°C resistor type), its sensor curve is SGH (120°C resistor type); if select the SGD (120°C resistor type), the temperature sensor curve is SGD curve.
- When there is difference between standard sensor curves and using sensor, user can adjust it in “curve type”.
- When input the sensor curve, X value (resistor) must be input from small to large, otherwise, mistake occurs.
- If there is no oil pressure sensor, but there is low oil pressure alarm switch, user must set the oil pressure sensor as “None”, otherwise, maybe low oil pressure shutdown occurs.
- The headmost or backmost values in the vertical coordinates can be set as same as below,

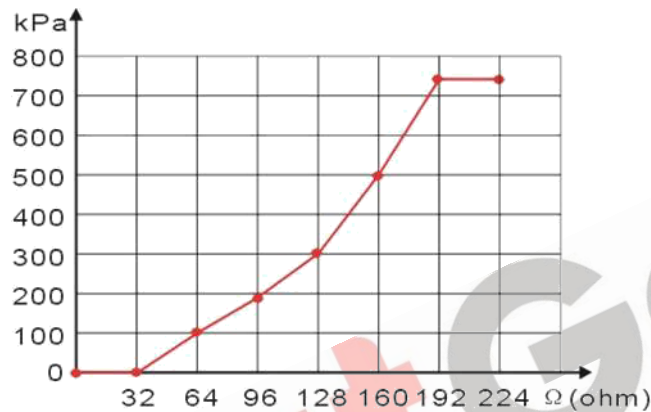

Table 12 Common unit conversion table

	N/m <sup>2</sup> (pa)	kgf/cm <sup>2</sup>	bar	(p/in <sup>2</sup> .psi)
1Pa	1	1.02x10 <sup>-5</sup>	1x10 <sup>-5</sup>	1.45x10 <sup>-4</sup>
1kgf/cm <sup>2</sup>	9.8x10 <sup>4</sup>	1	0.98	14.2
1bar	1x10 <sup>5</sup>	1.02	1	14.5
1psi	6.89x10 <sup>3</sup>	7.03x10 <sup>-2</sup>	6.89x10 <sup>-2</sup>	1

## 10 COMMISSIONING

Please make sure the following checks are made before commissioning,

- Ensure all the connections are correct and wires diameter is suitable.
- Ensure that the controller DC power has fuse, controller's positive and negative connected to start battery are correct.
- Emergency stop input is connected to the positive pole of starter battery via emergency stop button's normally closed point and fuse.
- Take proper action to prevent engine to crank success (e. g. Remove the connection wire of fuel valve). If checking is OK, make the start battery power on; choose manual mode and controller will executive routine.
- Set controller under manual mode, press "start" button, genset will start. After the cranking times as setting, controller will send signal of Start Failure; then press "stop" to reset controller.
- Recover the action to prevent engine to crank success (e. g. Connect wire of fuel valve), press start button again, genset will start. If everything goes well, genset will normal running after idle running (if idle run be set). During this time, please watch for engine's running situations and AC generator's voltage and frequency. If abnormal, stop genset and check all wires connection according to this manual.
- Select the **AUTO** mode from controller's panel, connect mains signal. After the mains normal delay, controller will transfer ATS (if fitted) into mains load. After cooling time, controller will stop genset and make it into "at rest" mode until there is mains abnormal situation.
- When mains is abnormal again, genset will be started automatically and enter into normal running, then controller send signal to making generator switch on, and control the ATS transfer into generator load. If not like this, please check ATS' wires connection according to this manual.
- If there is any other question, please contact SmartGen's service.

11 TYPICAL APPLICATION

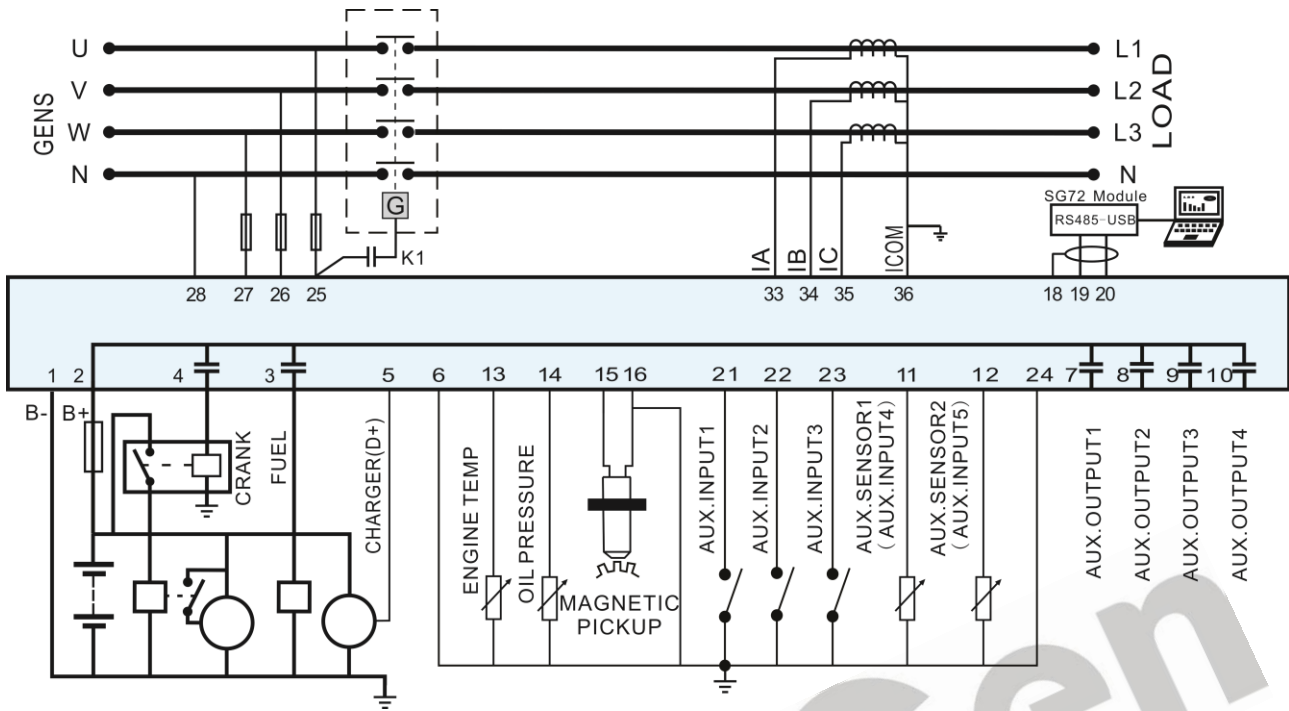

Fig.4 - HGM4010NC Typical Application

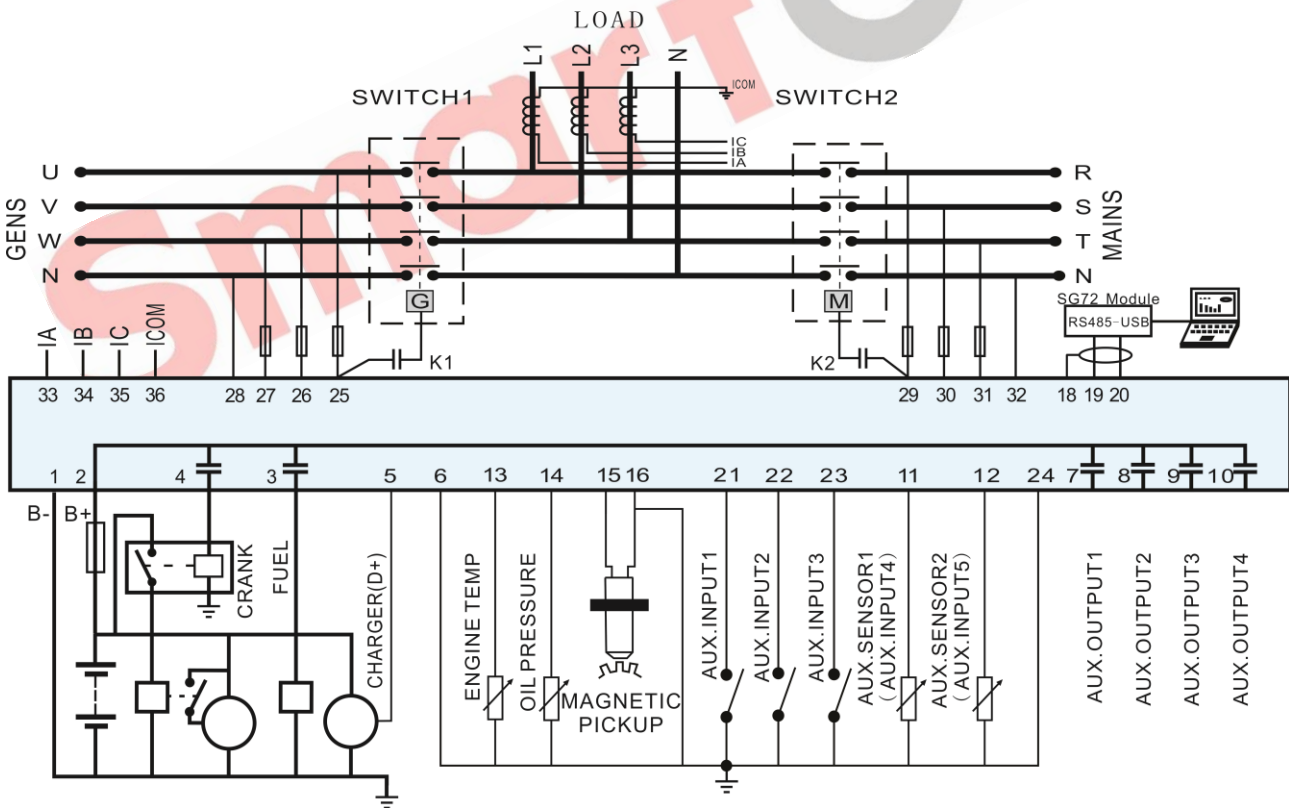

Fig.5 - HGM4020NC Typical Application

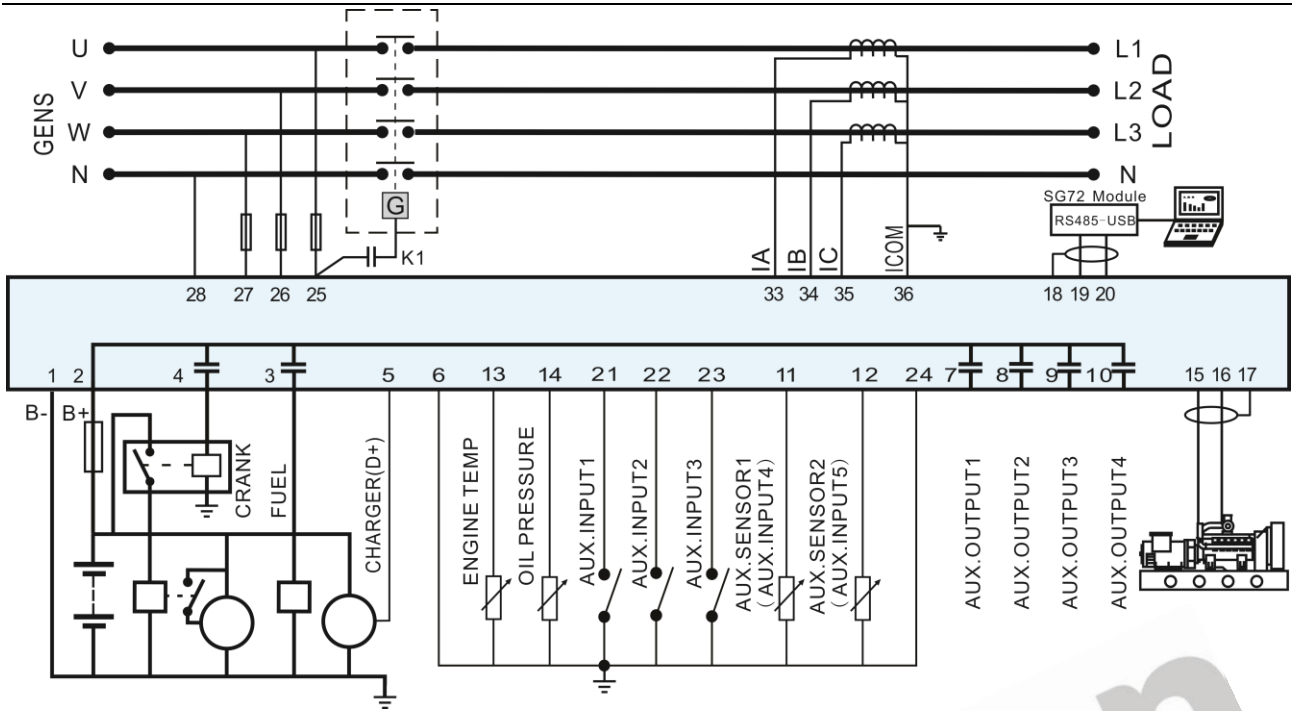

Fig.6 - HGM4010CAN Typical Application

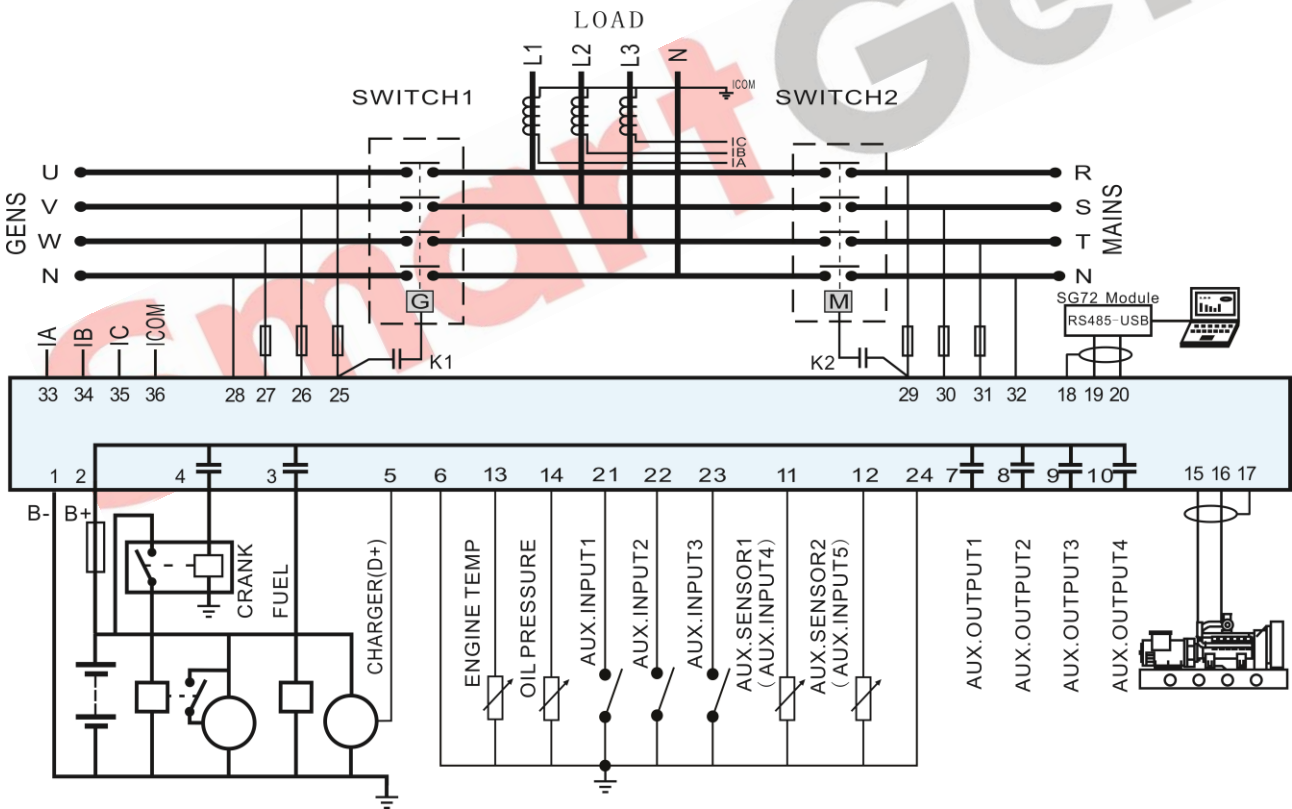

Fig.7 - HGM4020CAN Typical Application

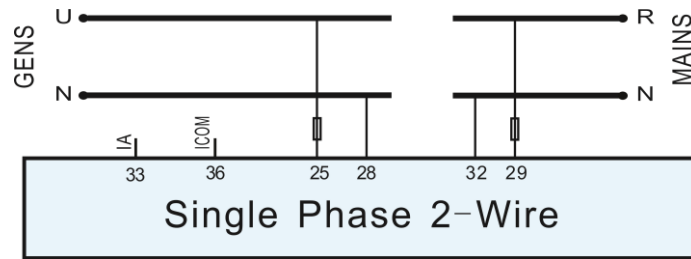

Fig.8 - Single Phase 2-Wire Connection Diagram

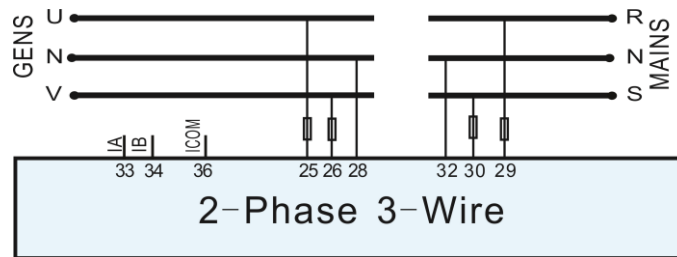
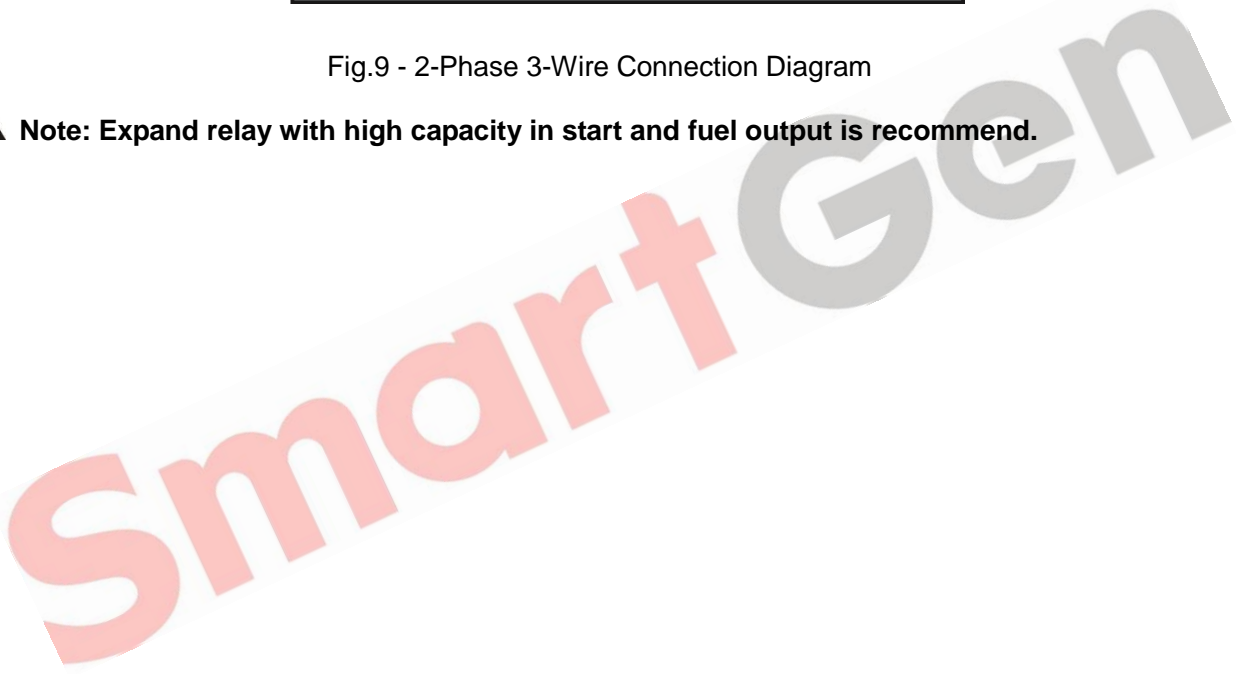

Fig.9 - 2-Phase 3-Wire Connection Diagram

**▲ Note: Expand relay with high capacity in start and fuel output is recommend.**



## 12 INSTALLATION

### 12.1 FIXING CLIPS

- 1) Controller is panel built-in design; it is fixed by clips when installed.
- 2) Withdraw the fixing clip screw (turn anticlockwise) until it reaches proper position.
- 3) Pull the fixing clip backwards (towards the back of the module) ensuring two clips are inside their allotted slots.
- 4) Turn the fixing clip screws clockwise until they are fixed on the panel.

**▲ Note:** Care should be taken not to over tighten the screws of fixing clips.

### 12.2 OVERALL DIMENSION

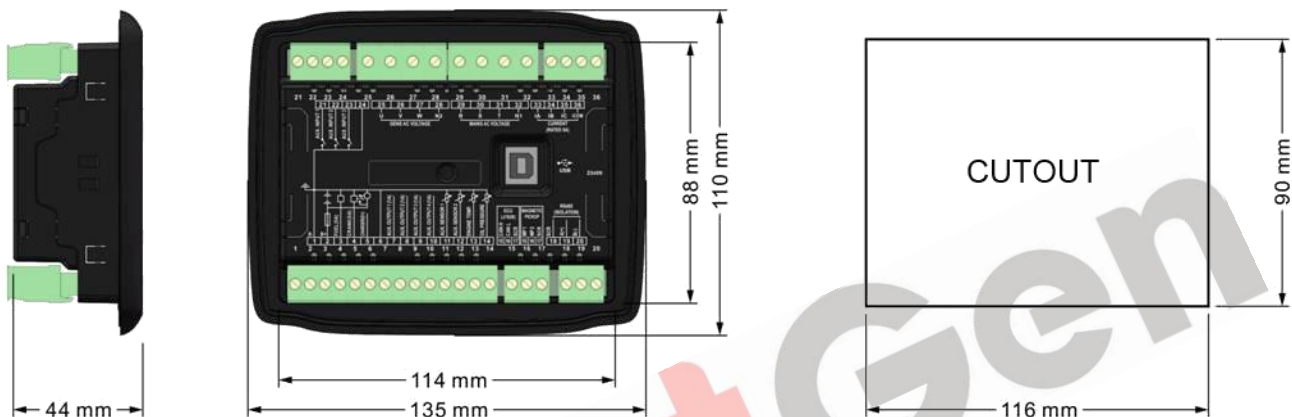

Fig.10 - Overall Dimensions

HGM4000N series controller can suit for widely range of battery voltage DC(8~35)V. Negative of battery must be connected with the engine shell. Diameter of wire that connects from power supply to battery must be over  $2.5\text{mm}^2$ . If floating charge configured, please firstly connect output wires of charger to battery's positive and negative directly, then, connect wires from battery's positive and negative to controller's positive and negative input ports in order to prevent charge disturbing the controller's normal working.

#### — SPEED SENSOR INPUT

Speed sensor is the magnetic equipment which be installed in starter and for detecting flywheel teeth. Its connection wires to controller should apply for 2 cores shielding line. The shielding layer should connect to No. 17 terminal in controller while another side is hanging in air. The else two signal wires are connected to No.1 and No.17 terminals in controller. The output voltage of speed sensor should be within AC(1~24)V (effective value) during the full speed. AC12V is recommended (in rated speed). When install the speed sensor, let the sensor is spun to contacting flywheel first, then, port out 1/3 lap, and lock the nuts of sensor at last.

#### — OUTPUT AND EXPAND RELAYS

All outputs of controller are relay contact output type. If need to expand the relays, please add freewheel diode to both ends of expand relay's coils (when coils of relay has DC current) or, increase resistance-capacitance return circuit (when coils of relay has AC current), in order to prevent disturbance to controller or others equipment.

#### — AC INPUT

Current input of controller must be connected to outside current transformer. And the current transformer's secondary side current must be 5A. At the same time, the phases of current transformer and input voltage must correct. Otherwise, the current of collecting and active power maybe not correct.



**▲NOTE:**

- 1) ICOM port must be connected to negative pole of battery.
- 2) When there is load current, transformer's secondary side prohibit open circuit.

**— WITHSTAND VOLTAGE TEST**

When controller had been installed in control panel, if need the high voltage test, please disconnect controller's all terminal connections, in order to prevent high voltage into controller and damage it.

SmartGen

## 13 CONNECTIONS OF CONTROLLER WITH J1939 ENGINE

### 13.1 CUMMINS ISB/ISBE

Table13 – Connector B

Terminals of controller	Connector B	Remark
Programmable output port 1	39	Set configurable output 1 as “Fuel Relay Output”
Start relay output	-	Connect with starter coil directly
Programmable output port 2	Expand 30A relay, battery voltage of 01,07,12,13 is supplied by relay.	ECU power Set configurable output 2 as “ECU power”

Table 14 – 9 Pins Connector

Terminals of controller	9 pins connector	Remark
CAN_SCR	SAE J1939 shield	CAN communication shielding line(connect to ECU terminal only)
CAN(H)	SAE J1939 signal	Using impedance 120Ω connecting line.
CAN(L)	SAE J1939 return	Using impedance 120Ω connecting line.

**Engine type:** Cummins ISB

### 13.2 CUMMINS QSL9

Suitable for CM850 engine control mode

Table 15 – 50 Pins Connector

Terminals of controller	50 pins connector	Remark
Programmable output port 1	39	Set configurable output 1 as “Fuel Relay Output”
Start relay output	-	Connect to starter coil directly

Table 16 – 9 Pins Connector

Terminals of controller	9 pins connector	Remark
CAN_SCR	SAE J1939 shield-E	CAN communication shielding line(connect to ECU terminal only)
CAN(H)	SAE J1939 signal-C	Using impedance 120Ω connecting line
CAN(L)	SAE J1939 return-D	Using impedance 120Ω connecting line

**Engine type:** Cummins-CM850

### 13.3 CUMMINS QSM11 (import)

It is suitable for CM570 engine control mode. Engine type is QSM11 G1, QSM11 G2.

Table 17 – C1 Connector

Terminals of controller	C1 connector	Remark
Programmable output1	5&8	Set configurable output 1 as “Fuel Relay Output”. Outside expand relay, when fuel output, making make port 5 and port 8 of C1 be connected
Start relay output	-	Connect to starter coil directly

Table 18 – 3 Pins Data Link Connector

Terminals of controller	3 pins data link connector	Remark
CAN_SCR	C	CAN communication shielding line(connect to ECU terminal only)
CAN(H)	A	Using impedance 120Ω connecting line
CAN(L)	B	Using impedance 120Ω connecting line

**Engine type:** Cummins ISB

### 13.4 CUMMINS QSX15-CM570

It is suitable for CM570 engine control module. Engine type is QSX15.

Table 19 – 50 Pins Connector

Terminals of controller	50 pins connector	Remark
Programmable output1	38	Oil spout switch; Set configurable output 1 as “Fuel Relay Output”.
Start relay output	-	Connect to starter coil directly

Table 20 – 9 Pins Connector

Terminals of controller	9 pins connector	Remark
CAN_SCR	SAE J1939 shield-E	CAN communication shielding line(connect to ECU terminal only)
CAN(H)	SAE J1939 signal-C	Using impedance 120Ω connecting line
CAN(L)	SAE J1939 return-D	Using impedance 120Ω connecting line

**Engine type:** Cummins QSX15-CM570

### 13.5 CUMMINS GCS-MODBUS

It is suitable for GCS engine control module. Use RS485-MODBUS to read information of engine. Engine types are QSX15, QST30, QSK23 / 45/60/78 and so on.

Table 21 – D-SUB Connector 6

Terminals of controller	D-SUB connector 06	Remark
Programmable output1	5&8	Set configurable output 1 as “Fuel Relay Output”. Outside expand relay, when fuel output, connect port 06 and 08 of the connector
Start relay output	-	Connect to starter coil directly

Table 22 – D-SUB Connector 06

Terminals of controller	D-SUB connector 06	Remark
RS485 GND	20	CAN communication shielding line(connect to ECU terminal only)
RS485+	21	Using impedance 120Ω connecting line
RS485-	18	Using impedance 120Ω connecting line

**Engine type:** Cummins QSK-MODBUS, Cummins QST-MODBUS, Cummins QSX-MODBUS

### 13.6 CUMMINS QSM11

Table 23 – Engine OEM Connector

Terminals of controller	OEM connector of engine	Remark
Programmable output1	38	Set configurable output 1 as “Fuel Relay Output”.
Start relay output	-	Connect with starter coil directly
CAN_SCR	-	CAN communication shielding line(connect with controller’s this terminal only)
CAN(H)	46	Using impedance 120Ω connecting line
CAN(L)	37	Using impedance 120Ω connecting line

**Engine type:** common J1939

### 13.7 CUMMINS QSZ13

Table 24 – Engine OEM Connector

Terminals of controller	OEM connector of engine	Remark
Programmable output1	45	
Start relay output	-	Connect to starter coil directly
Programmable output 2	16&41	Setting to idle speed control, normally open output. Making 16 connect to 41 during high-speed running of controller via external expansion relay.
Programmable output 3	19&41	Setting to pulse raise speed control, normally open output. Making 19 connect with 41 for 0.1s during high-speed warming

Terminals of controller	OEM connector of engine	Remark
		of controller via external expansion relay.
CAN_SCR	-	CAN communication shielding line.
CAN(H)	1	Using impedance 120Ω connecting line
CAN(L)	21	Using impedance 120Ω connecting line

**Engine type: Common J1939**

**13.8DETROIT DIESEL DDEC III / IV**

Table 25 – Engine CAN Connector

Terminals of controller	CAN port of engine	Remark
Programmable output1	Expand 30A relay, battery voltage is supplied by relay.	Set configurable output 1 as “Fuel Relay Output”.
Start relay output	-	Connect to starter coil directly
CAN_SCR	-	CAN communication shielding line
CAN(H)	CAN(H)	Using impedance 120Ω connecting line
CAN(L)	CAN(L)	Using impedance 120Ω connecting line

**Engine type:** J1939 common used

**13.9DEUTZ EMR2**

Table 26 – F Connector

Terminals of controller	F connector	Remark
Programmable output1	Expand 30A relay, battery voltage of 14 is supplied by relay. Fuse is 16A	Set configurable output 1 as “Fuel Relay Output”.
Start relay output	-	Connect to starter coil directly
-	1	Connect to battery negative pole
CAN_SCR	-	CAN communication shielding line
CAN(H)	12	Using impedance 120Ω connecting line
CAN(L)	13	Using impedance 120Ω connecting line

**Engine type:** VolvoEDC4

### 13.10 JOHN DEERE

Table 27 – 21 Pins Connector

Terminals of controller	21 pins connector	Remark
Programmable output1	G,J	Set configurable output 1 as “Fuel Relay Output”.
Start relay output	D	
CAN_SCR	-	CAN communication shielding line
CAN(H)	V	Using impedance 120Ω connecting line
CAN(L)	U	Using impedance 120Ω connecting line

**Engine type:** John Deere

### 13.11 MTU MDEC

Suitable for MTU engines, 2000 series, 4000series

Table 28 - X1 Connector

Terminals of controller	X1 connector	Remark
Programmable output1	BE1	Set configurable output 1 as “Fuel Relay Output”.
Start relay output	BE9	
CAN GND	E	CAN communication shielding line(connect to one terminal only)
CAN(H)	G	Using impedance 120Ω connecting line
CAN(L)	F	Using impedance 120Ω connecting line

**Engine type:** MTU-MDEC-303

### 13.12 MTU ADEC(SMART module)

It is suitable for MTU engine with ADEC (ECU8) and SMART module.

Table 29 – ADEC (X1 port)

Terminals of controller	ADEC (X1port)	Remark
Programmable output1	X1 10	Set configurable output 1 as “Fuel Relay Output”. X1 Terminal 9 Connected to negative of battery
Start relay output	X1 34	X1 Terminal 33 Connected to negative of battery

Table 30 - SMART (X4 port)

Terminals of controller	SMART (X4 port)	Remark
CAN_SCR	X4 3	CAN communication shielding line
CAN(H)	X4 1	Using impedance 120Ω connecting line
CAN(L)	X4 2	Using impedance 120Ω connecting line

**Engine type:** MTU-ADEC

### 13.13 MTU ADEC(SAM module)

It is suitable for MTU engine with ADEC (ECU7) and SAM module.

Table 31 – ADEC (X1 port)

Terminals of controller	ADEC (X1port)	Remark
Programmable output1	X1 43	Set configurable output 1 as “Fuel Relay Output”. X1 Terminal 28 Connected to negative of battery
Start relay output	X1 37	X1 Terminal 22 Connected to negative of battery

Table 32 – SAM (X23 port)

Terminals of controller	SAM (X23 port)	Remark
CAN_SCR	X23 3	CAN communication shielding line
CAN(H)	X23 2	Using impedance 120Ω connecting line
CAN(L)	X23 1	Using impedance 120Ω connecting line

**Engine type: Common J1939**

### 13.14 PERKINS

It is suitable for ADEM3/ ADEM4 engine control mode. Engine type is 2306, 2506, 1106, and 2806.

Table 33 - Connector

Terminals of controller	Connector	Remark
Programmable output1	1,10,15,33,34	Set configurable output 1 as “Fuel Relay Output”.
Start relay output	-	Connect to starter coil directly
CAN_SCR	-	CAN communication shielding line
CAN(H)	31	Using impedance 120Ω connecting line
CAN(L)	32	Using impedance 120Ω connecting line

**Engine type: Perkins**

### 13.15 SCANIA

It is suitable for S6 engine control mode. Engine type is DC9, DC12, and DC16.

Table 34 – B1 Connector

Terminals of controller	B1 connector	Remark
Programmable output1	3	Set configurable output 1 as “Fuel Relay Output”
Start relay output	-	Connect to starter coil directly
CAN_SCR	-	CAN communication shielding line
CAN(H)	9	Using impedance 120Ω connecting line
CAN(L)	10	Using impedance 120Ω connecting line

**Engine type: Scania**

### 13.16 VOLVO EDC3

Suitable engine control mode is TAD1240, TAD1241, and TAD1242.

Table 35 – “Stand alone” Connector

Terminals of controller	“Stand alone” connector	Remark
Programmable output1	H	Set configurable output 1 as “Fuel Relay Output”
Start relay output	E	
Configurable output 2	P	ECU power Configurable output 2, "ECU power"

Table 36 – “Data bus” Connector

Terminals of controller	“Data bus” connector	Remark
CAN_SCR	-	CAN communication shielding line
CAN(H)	1	Using impedance 120Ω connecting line
CAN(L)	2	Using impedance 120Ω connecting line

**Engine type:** Volvo

**NOTE:** When this engine type is selected, preheating time should be set to at least 3 seconds.

### 13.17 VOLVO EDC4

Suitable engine types are TD520, TAD520 (optional), TD720, TAD720 (optional), TAD721, TAD722, and TAD732.

Table 37 - Connector

Terminals of controller	Connector	Remark
Programmable output1	Expanded 30A relay, and relay offers battery voltage to terminal 14. Fuse is 16A	Set configurable output 1 as “Fuel Relay Output”
Start relay output	-	Connect to starter coil directly
	1	Connected to negative of battery
CAN GND	-	CAN communication shielding line
CAN(H)	12	Using impedance 120Ω connecting line
CAN(L)	13	Using impedance 120Ω connecting line

**Engine type:** VolvoEDC4

### 13.18 VOLVO-EMS2

Volvo Engine types are TAD734, TAD940, TAD941, TAD1640, TAD1641, and TAD1642.

Table 38 – Engine CAN Port

Terminals of controller	Engine’s CAN port	Remark
Programmable output1	6	ECU stop Configurable output 1 “ECU stop”
Programmable output2	5	ECU power Configurable output 2 “ECU power”
	3	Negative power
	4	Positive power
CAN_SCR	-	CAN communication shielding line
CAN(H)	1(Hi)	Using impedance 120Ω connecting line



Terminals of controller	Engine's CAN port	Remark
CAN(L)	2(Lo)	Using impedance 120Ω connecting line

**Engine type:** Volvo-EMS2

**▲ NOTE:** When this engine type is selected, preheating time should be set to at least 3 seconds.

### 13.19 Yuchai

It is suitable for BOSCH common rail pump engine.

Table 39 – Engine 42 Pins Port

Terminals of controller	Engine 42 pins port	Remark
Programmable output1	1.40	Set configurable output 1 as “Fuel Relay Output”. Connect to engine ignition lock
Start relay output	-	Connect to starter coil directly
CAN_SCR	-	CAN communication shielding line
CAN(H)	1.35	Using impedance 120Ω connecting line
CAN(L)	1.34	Using impedance 120Ω connecting line

Table 40 – Engine 2 Pins Port

Battery	Engine 2 pins	Remark
Battery negative	1	Wire diameter 2.5mm <sup>2</sup>
Battery positive	2	Wire diameter 2.5mm <sup>2</sup>

**Engine type:** BOSCH

### 13.20 Weichai

It is suitable for Weichai BOSCH common rail pump engine.

Table 41 – Engine Port

Terminals of controller	Engine port	Remark
Fuel relay output	1.40	Connect to engine ignition lock
Start relay output	1.61	
CAN_SCR	-	CAN communication shielding line
CAN(H)	1.35	Using impedance 120Ω connecting line
CAN(L)	1.34	Using impedance 120Ω connecting line

**Engine type:** GTSC1

**▲ NOTE:** If there is any question of connection between controller and ECU communication, please feel free to contact SmartGen service.

**14 FAULT FINDING**

Table 42 - Fault and Solutions

Symptoms	Possible Solutions
Controller no response with power.	Check starting batteries; Check controller connection wirings; Check DC fuse.
Genset shutdown	Check the water/cylinder temperature is too high or not; Check the genset AC voltage; Check DC fuse.
Low oil pressure alarm after crank disconnect	Check the oil pressure sensor and its connections.
High water temp. alarm after crank disconnect	Check the temperature sensor and its connections.
Shutdown Alarm in running	Check related switch and its connections according to the information on LCD; Check programmable inputs.
Crank not disconnect	Check fuel oil circuit and its connections; Check starting batteries; Check speed sensor and its connections; Refer to engine manual.
Starter no response	Check starter connections; Check starting batteries.
Genset running while ATS not transfer	Check ATS; Check the connections between ATS and controllers.
RS485 communication is abnormal	Check connections; Check setting of COM port is correct or not; Check RS485's connections of A and B is reverse connect or not; Check RS485 transfer model whether damage or not; Check communication port of PC whether damage.