

HG-SERIES Air Circuit Breakers

Instruction Manual



Type covered in this manual

- HGN Type : HGN06, HGN08, HGN10, HGN12, HGN16, HGN20, HGN25, HGN32, HGN40, HGN50, HGN63
- HGS Type : HGS06, HGS08, HGS10, HGS12, HGS16, HGS20, HGS25, HGS32

Notice

- Read this instruction manual carefully before using this Air Circuit Breaker.
- This instruction manual does not include all information regarding installation and maintenance.
- For further information, please contact Hyundai Electric or your local dealer.

For Operational Safety of Air Circuit Breakers

Safety Practices

This instruction manual applies only to HG-Series air circuit breakers (ACB) regarding installation and maintenance procedures. Installing and maintaining these products improperly may result in serious personal injury, property damage, or even death. Therefore this instruction manual must be read and understood at any step in unpacking, assembly, operation, and maintenance of the breaker. Only qualified persons who are familiar with installing and maintaining circuit breakers are permitted to work on breakers, and this instruction manual should be accessible to those persons at any time.

Signal Words

Signal words used in this instruction manual are divided by DANGER, WARNING, and CAUTION depending on the situation.

⚠ DANGER Indicates an imminently hazardous point that, if ignored, a serious accident causing death or severe injury could occur. This is the most dangerous point.

⚠ WARNING Indicates a potentially hazardous point that, if ignored, a serious accident causing death or severe injury could occur.

⚠ CAUTION Indicates a potentially hazardous point that, if ignored, minor or moderate injury could occur. This signal reminds operators to work safely.

Transportation Precaution

⚠ DANGER Never lift the ACB over an area where there are people.
Never stand under the ACB.

OCR Field Test Precautions

⚠ CAUTION

- OCR field tests and setting changes must be performed by qualified personnel.
- After completion of OCR tests, make sure to return the original values.
- Failure to do may cause a fire or burnout.

Operation Precautions

⚠ DANGER

- Never touch live terminal parts.
There is a risk of electric shock.
- Do not leave the ACB in the draw-out position.
Dropping the ACB cause serious injury.

⚠ CAUTION

- If the ACB trips open automatically, remove the cause before closing the ACB.
Otherwise, a fire could occur.
- For the ACB with the fixing block, be sure to loosen the block screws before drawing out the ACB.
Otherwise, damage to the ACB may occur.

Installation Precautions

CAUTION

- Installation work must be performed by qualified personnel.
- Prior to commencing any installation work, open an upstream circuit breaker to shut off all sources of power.
Otherwise, electric shock may occur.
- Tighten terminal bolt up securely to the specified torque.
Otherwise, a fire may occur.
- Fix the draw-out cradle of the ACB firmly on a flat level surface using mounting screws.
Otherwise, draw-out operation may cause the ACB to fall.
- To ensure adequate arc space (insulation distance), avoid blocking the arc gas vents of the ACB.
Otherwise a burn may result from high temperature arc gas.
- Do not place the ACB in such as an area that is subject to high temperature, high humidity, dusty air, corrosive gas, vibration and shock, or other unusual conditions.
Mounting in such area could cause a fire, non-tripping, or malfunction.
- Install the ACB to prevent dust, concrete powder, iron powder, and rainwater from entering the unit.
These materials could cause a fire or non-tripping.
- For the ACB with four poles, connect the neutral wire of a 3-phase, 4-wire cable to the N-phase pole (on the right end).
Otherwise, an overcurrent may cause non-tripping resulting a fire.

Maintenance and Inspection Precautions

CAUTION

- ACB maintenance, inspection and/or parts replacement must be performed by qualified personnel.
- Prior to commencing any work on the ACB, open an upstream breaker or the like to isolate all sources of power/voltage from both the primary and auxiliary circuits.
Otherwise, electric shock may result.
- Prior to commencing ACB internal inspection, make sure that the ACB is open and the closing spring is released.
Otherwise, fingers or tools could be pinched in the internal mechanism, resulting injury.
- Retighten the terminal screws periodically to the specified torque.
Otherwise, a fire could result.
- Be sure to reinstall the arc chamber if removed.
Failure to do so or incorrect installation of the arc chamber may result in a fire or burn.
- Do not touch ACB live parts (contacts in particular), or structural parts close to a live part immediately after opening the ACB to stop supplying power.
Otherwise, remaining heat may cause burn or residual charged voltage may cause electric shock.
- Do not bring your hand or face close to the arc gas vent of the arc chute while the ACB is closed.
Otherwise, a burn may result from high-temperature arc gas blowing out of the arc gas vent when the ACB trips open.

Contents

1. Receiving and Handling	
1.1 Storage	5
1.2 Transportation	5
1.3 Installation	5
2. Structure	7
3. Operation	
3.1 Manual Charging Type	8
3.2 Motor Charging Type	9
4. Draw-out Mechanism	10
4.1 Draw-out Operation	11
4.2 Draw-in Operation	13
5. Periodic Inspection and Parts Replacement	14
5.1 Arc Chamber	15
5.2 Contact Unit	16
5.3 Operating Mechanism	17
5.4 Internal Accessories	18
6. Protection Relay-GPR	24
6.1 Rated Current	26
6.2 Protective Functions and Setting Ranges	26
6.3 Operation Indication Functions	29
6.4 Field Test	30
6.5 Characteristic Check	32
6.6 Operating Manual for GPR-LA, LAG, LAZ, LP, LH, SA, SP Type	35
7. Insulation Resistance Test and Dielectric Withstand Test	
7.1 Main Circuit	41
7.2 Control Circuit (to earth)	41
8. Troubleshooting Points	42
9. Appendix	
9.1 Neutral CT and GPR Protection Relay Connection Methods	43
9.2 Ground Protection Method	44
9.3 Closing and Trip Operation Cycle	45
9.4 Wiring Circuit for GPR Protection Relay	46
9.5 Wiring Circuit for ACB	50

01 Receiving and Handling

Upon receipt of your breaker, check the following first.

HE air circuit breakers are completely assembled, inspected and tested both electrically and mechanically at the factory, then shipped in fully guaranteed condition in construction and operation.

1.1 Storage

While it is recommended that the breaker be used as soon as you have received it. If it is necessary to store the ACB, note the followings.

- 1) Store the breaker in a dry indoor location to prevent condensation due to sudden changes in ambient temperature, which is quite harmful to the breaker insulation.
- 2) Store the breaker in a clean place free of corrosive gases, dirt, dust and salinity (NaCl).
In particular, a mixture of cement dust and moisture may cause corrosion damage to metal parts of the ACB.
Fully protect the breaker from such mixtures.
- 3) Place the breaker on a flat, level surface in its normal position.
- 4) Do not place the breaker directly on the floor.
- 5) When store the ACB without electronic circuit : $-25\text{ }^{\circ}\text{C} - 85\text{ }^{\circ}\text{C}$
When store the ACB with electrofin circuit : $-15\text{ }^{\circ}\text{C} - 70\text{ }^{\circ}\text{C}$

1.2 Transportation

When transporting the breaker, follow these instructions.

- 1) When lifting up the breaker, suspend wire rope from lifting lug and take care to ensure that the wire ropes do not touch the arc chute and protection relay. When lifting up the breaker, be sure to lift it up slowly.
- 2) Lower the breaker onto a flat surface.
- 3) Avoid impacts and shocks to the breaker during transportation.

1.3 Installation

- 1) Ambient temperature : from $-5\text{ }^{\circ}\text{C}$ to $+40\text{ }^{\circ}\text{C}$ (24 hours average temperature should not exceed $35\text{ }^{\circ}\text{C}$).
- 2) Altitude : Less than 2,000 m
- 3) In case of special environment application

(1) Derating table for the altitude over 2,000 m

Altitude	$\leq 2,000\text{ m}$	3,000 m	4,000 m	5,000 m
Rated voltage	690 V	590 V	520 V	460 V
Rated current	100 %	99 %	96 %	94 %

01 Receiving and Handling

(3) Clearance requirements

Minimum Space Distance	A	B
Insulate parts	150 mm	50 mm
Metal parts	150 mm	50 mm

- ※ - In case of arc shield application, ignore "A" size.
- In case of mechanical interlock application, it needs extra space over "B" size.

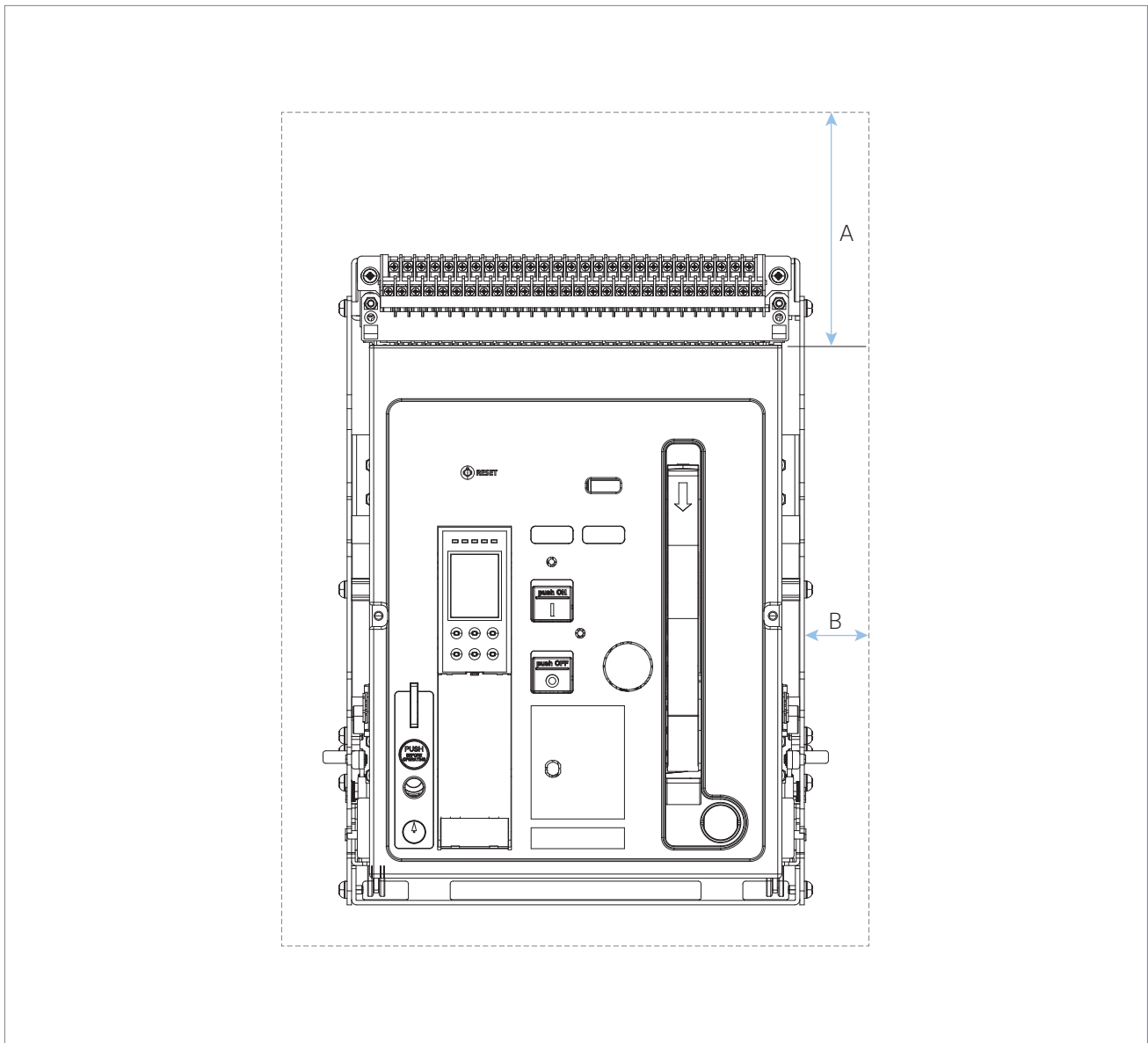

02 Structure

Fig. 1

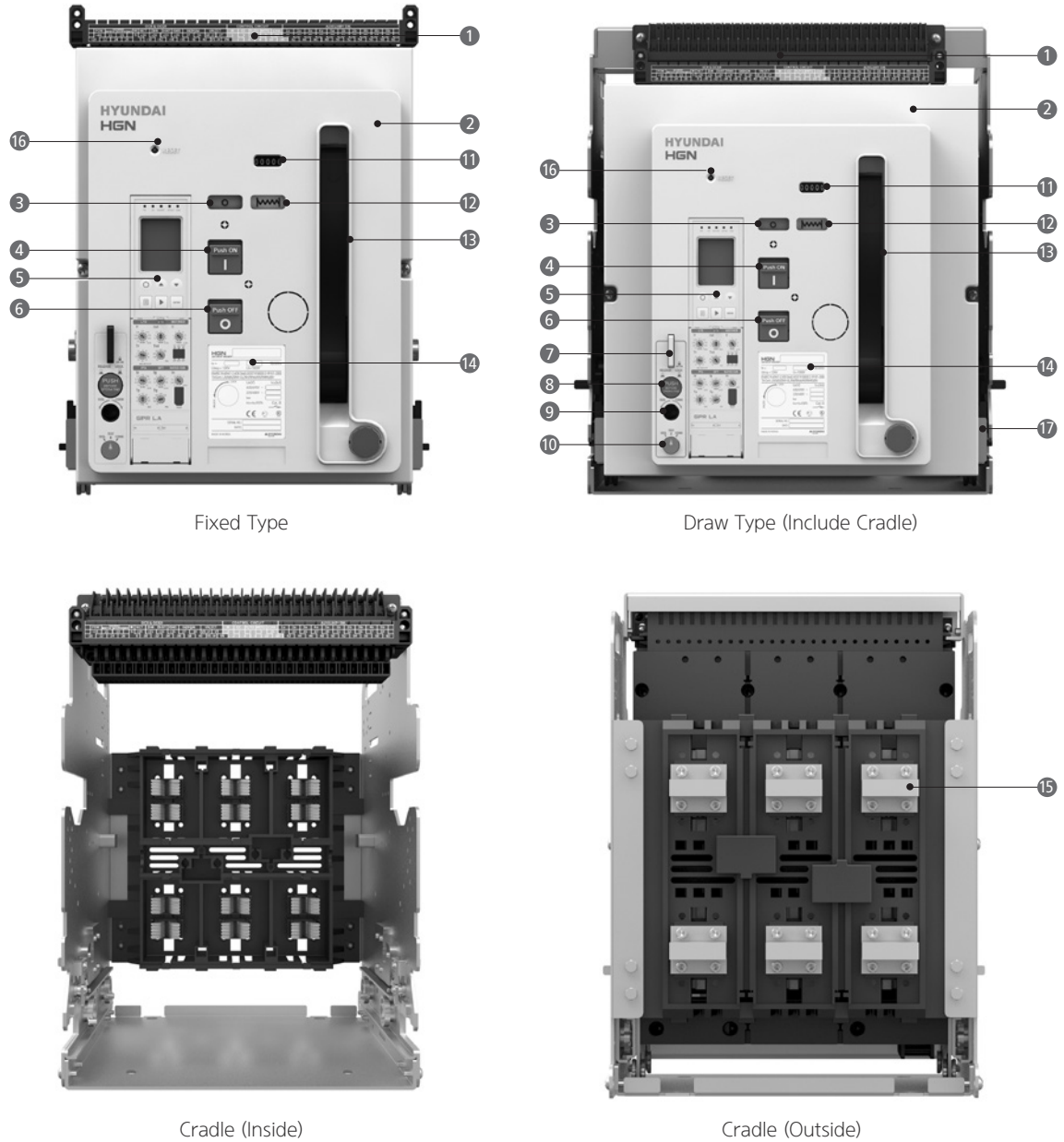

- | | | |
|----------------------------|-------------------------------------|-----------------------|
| ① Control circuit terminal | ⑦ Position padlock | ⑬ Charging handle |
| ② Front cover | ⑧ Position lock release button | ⑭ Name plate |
| ③ Close/Open indicator | ⑨ Draw-in/out handle insertion hole | ⑮ Busbar terminal |
| ④ Close button | ⑩ Position indicator | ⑯ OCR Manual reset |
| ⑤ Protection relay (GPR) | ⑪ Cycle counter | ⑰ Draw-out guide rail |
| ⑥ Open button | ⑫ Charged/Discharged indicator | |

03 Operation

Air circuit breakers are available either manual charging type or motor charging type.

3.1 Manual Charging Type

In the manual charging type, both charging the closing springs and open-close control of the breaker should be done manually. The breaker is able to close only when the closing spring is charged.

⚠ CAUTION

Do not force down the charging handle after completion of charging.

It may cause a malfunction.

1) Spring charging operation

Follow the procedure given below to charge the closing springs.

- Pump the charging handle (Fig. 2. ①) about five times.
- When closing springs are fully charged, a metallic click will be heard and no more pumping of the charging handle will be possible. Check that the spring charged indicator now shows 「**||||-I**」 (Fig. 2. ②).

2) Closing operation

Check the instruction before closing the breaker.

- Closing spring should be charged.
- Position lock release button should be in original position (Fig. 3. ①).
- Specified voltage should be applied to the under-voltage trip device option. See the description of the under-voltage trip device for the procedure in detail.

Upon satisfactory confirmation of the above three items, press the closing button (Fig. 3. ②).

Then, closing springs are discharged and the breaker is closed.

The close/open indicator indicates 「**I**」 and spring charged indicator shows 「**||||**」 (Fig. 3. ③).

3) Opening operation

Press the open button (Fig. 3. ④), close/open indicator indicates 「**O**」 (Fig. 3. ⑤).

Fig. 2

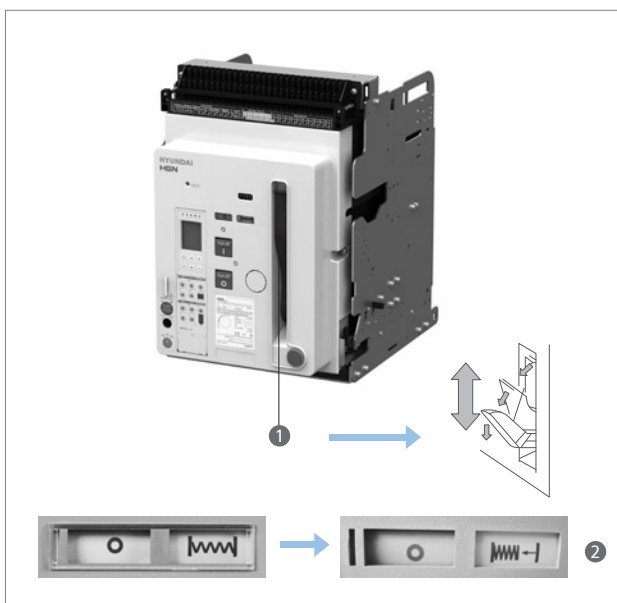
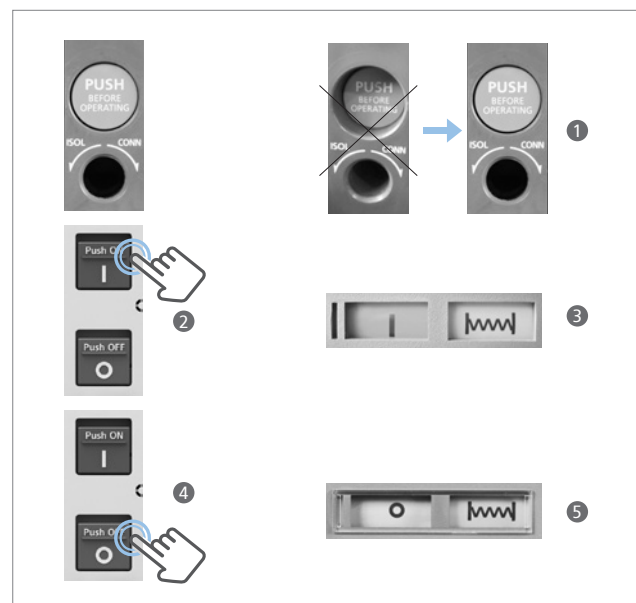

Fig. 3



3.2 Motor Charging Type

In this type, a motor-operated mechanism automatically charges the closing springs.

Means for remote electrical close-open control of the breaker are also fitted (see page 50-51 wiring circuit).

Manual operation is also possible (manual operation procedures are described in the 3.1 section manual charging type).

1) Spring charging operation

- Supply the specified control power voltage to the charging motor circuit.
- As soon as the closing springs are discharged, the charging motor is turned on to charge the closing springs.
- The charging motor is automatically stopped after the closing springs are fully charged.

Then, charged/discharged indicator show charged sign, 「」 (Fig. 2. ②).

Spring charging time is different according to control power and type of breaker.

This is normally within a range of 3 to 10 seconds.

⚠ CAUTION

The permissible control voltage range for the charging motor is from 85 % to 110 % but 100 % of rated voltage is more recommended to be supplied.

Failure to follow this instruction will result damage in charging motor.

⚠ CAUTION

It is strongly recommended to supply the control power at the rated voltage.

Dielectric withstand test in motor, AC/DC 100-220 V : 1,500 V 1 min, DC 24, 48 V : 500 V 1 min.

The motor jack should be disconnected before dielectric withstand test.

2) Closing operation

Before closing the breaker, check the followings.

- Closing springs are charged.
- Position lock release button should be in original position.
- Under voltage trip device (UVT) is supplying rated voltage.

Upon satisfactory confirmation of the above items, press the PB (Close) button (page 50-51).

This energizes LRC (latch release coil, Fig. 9. ④) which in turn release the closing springs and close the breaker.

Close/Open indicator indicates 「」 (Fig. 3. ③).

Charged/Discharged indicator indicates 「」 (Fig. 3. ③).

When closing springs are discharged, the charging motor immediately turn to charge closing springs.

⚠ CAUTION

Even when no. 2) is not satisfied, the breaker will not be placed in a closed state.

Be sure to perform closing operation according no. 2).

3) Opening operation

The shunt trip device (SHT) or under voltage trip device (UVT) is used for remote electrical opening operation.

Press the open button (PB open, page 50-51). This opens the breaker via the SHT or UVT.

⚠ CAUTION

When close-open operations are repeated with the charging motor ON, limit the number of successive close-open cycles to 10 times. If the open-close cycle is repeated more than 10 times, allow a cooling period of at least 10 minutes between the 10th cycle and the 11th cycle.

Repeating open-close cycle more than 10 times consecutively may damage of charging motor.

04 Draw-out Mechanism

In order to test the breaker and exchange parts easily, the breaker body is drawn-in/out from draw-out cradle, the breaker can be fixed in one among three of draw-out cradle.

The breaker can be moved to TEST or ISOLATED position when the panel door is closed.

Caution of operation

- Open the breaker before working with the draw-out mechanism.
- Loosen the screws of the fixing blocks before drawing out the breaker body.
- Push the position lock release button (Fig. 1. ⑧), insert draw-in/out handle into the insertion hole (Fig. 1. ⑨).
- When you try to move the breaker body to the CONNECTED position, the operating force will increase.
Torque of operating force is about 25 kgf.
- Operate draw-in/out handle totally in inserted state.
- Rotate draw-in/out handle until the handle is locked automatically at each ISOLATED, TEST, and CONNECTED position.
At each locked position, stop turning the draw-out handle.

Failure to follow this instruction can result in equipment damage or malfunction.

⚠ CAUTION

During the breaker body move from ISOLATED to CONNECTED position, or from CONNECTED to ISOLATED position, do not rotate the handle by releasing position locking.

CONNECTED position

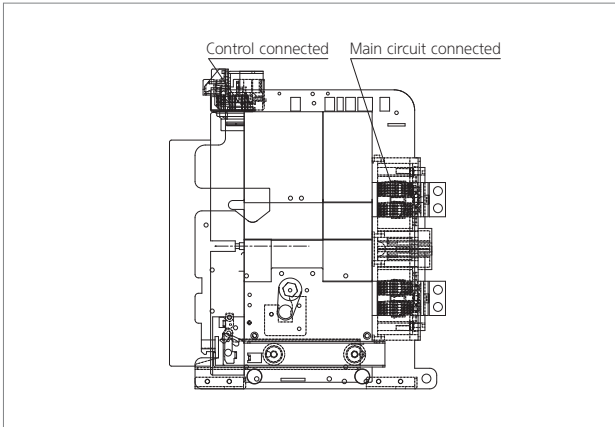

TEST position

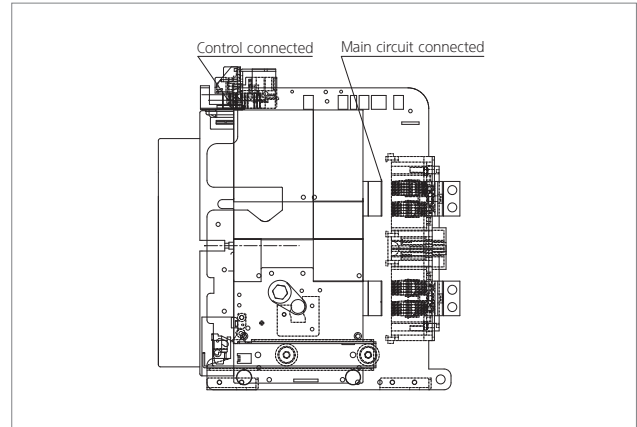

ISOLATED position

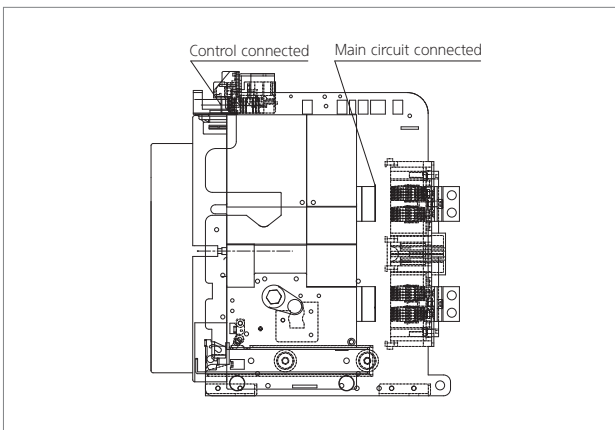

REMOVED position

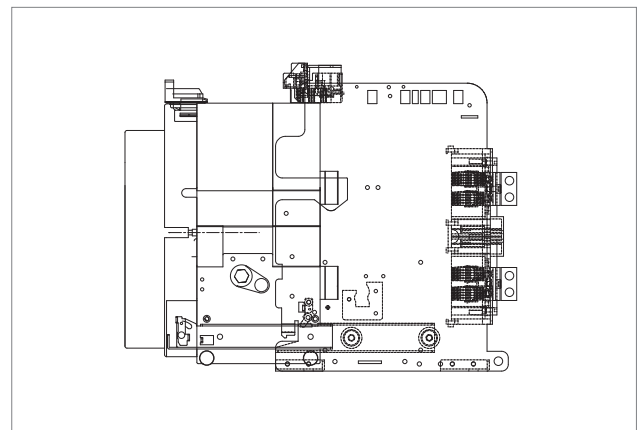

4.1 Draw-out Operation

The draw-in/out handle is used to move the breaker body to one of the three positions (CONNECTED, TEST, ISOLATED).

⚠ CAUTION

When the fixing blocks (Fig. 4. ② option) are fitted, loosen the right and left screws of the fixing blocks before drawing-out operation.

1) Moving from CONNECTED position to TEST position

- When the fixing blocks are fitted, loosen and free right and left screws. (Fig. 4. ③)
- Check that the breaker is open.
If it is closed, push open button (Fig. 4. ④) to open breaker.
- When the position lock release button is completely pushed in, connect draw-in/out handle to shaft fully. (Fig. 4. ⑦)
If it is not completely pushed in or not inserted, the body doesn't move and indicator doesn't rotate.
The position indicator is rotated while the breaker body drawn out.

⚠ CAUTION

When the main circuit is disconnected as the breaker body is being drawn out, the breaker body will be slightly pushed forward by the spring action of the primary disconnect contacts with a "banging" sound.

While the loudness of this sound may vary, the sound itself is perfectly normal and does not affect breaker performance.

Fig. 4

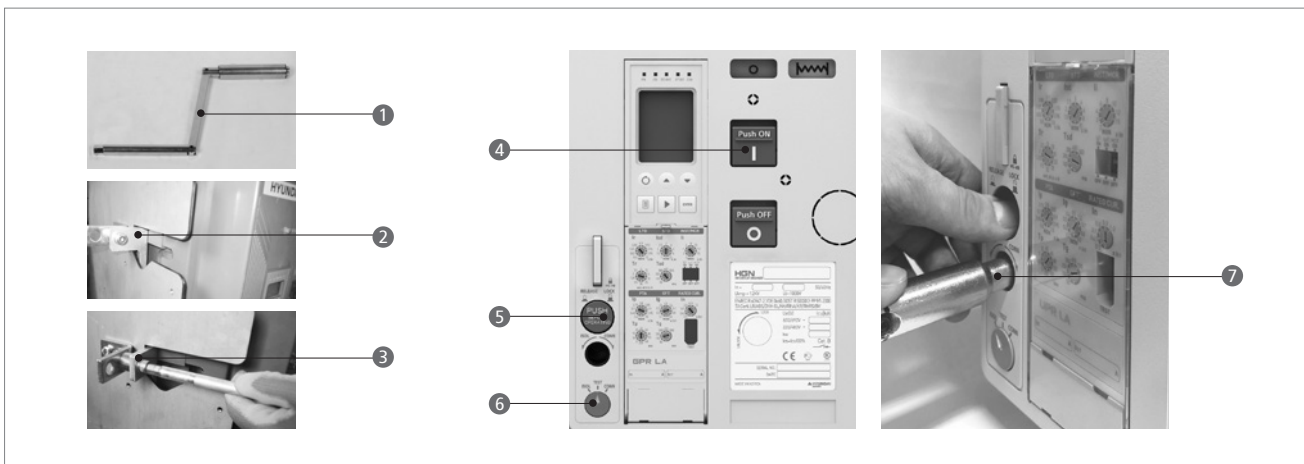

⚠ CAUTION

When position lock release button (Fig. 4. ⑤) is pushed, the breaker will not close.

In order to test operation, must move to the right position (CONNECTED, TEST, ISOLATED), and position lock release button (Fig. 4. ⑤) should be pushed out.

⚠ DANGER

When breaker body is drawn out to the TEST position or ISOLATED position, a metallic sound "click" will be heard, and the draw-in/out handle operation is automatically locked.

At this time, do not attempt to compulsively rotate the handle.

04 Draw-out Mechanism

2) Moving from TEST position to ISOLATED position

In order to move from TEST to ISOLATED, push position lock release button (Fig. 4. ⑤) shortly after handle locking is released, and turn the draw-in/out handle in a counterclockwise direction.

⚠ CAUTION

If it is approaching ISOLATED position, draw-in/out handle (Fig. 4. ①) will be automatically locked.
Do not attempt to compulsively rotate the handle.

3) Removing body from ISOLATED position

For maintenance, inspection, or exchanging parts, the breaker in the ISOLATED position should be drawn out from the draw-out cradle. If the breaker is charged, the breaker should release the closing springs, by using the manual close and open button.

- In order to pull out ACB from the cradle at the ISOLATED position, please push the lever (Fig. 5. ①②) placed at the both side of the Body.
- When the breaker is drawn-out perfectly, the breaker body (Fig. 5. ③) is stopped by rail end stoppers (Fig. 5. ④). To release the stoppers, pull down the Left/Right body lock (Fig. 5. ④) and take out the body slowly (Fig. 5. ⑤).

⚠ CAUTION

This operation should be done slowly.
Apply wire rope to the lifting lug and lift the body upward after releasing stoppers.

⚠ CAUTION

Don't leave the breaker in REMOVED position.
When the breaker is drawn out, the center of gravity is changed.
The draw-out cradle should be fixed in advance in the PNL.

Fig. 5

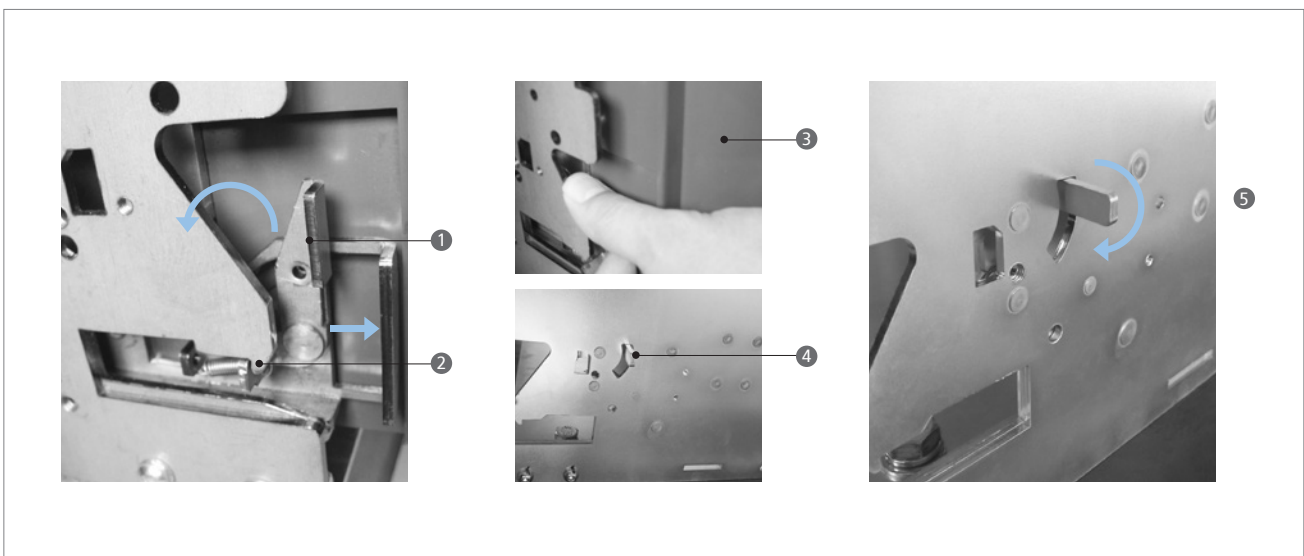

4.2 Draw-in Operation

In order to push back the breaker body to CONNECTED position, follow steps below.

- Check that the breaker is open. Also, check draw-in/out indicator shows isolated.
- Check charged/discharged indicator.
Indicator shows discharged 「」.
- Lift up the breaker body or use a special lifter.
Push in the breaker body until the body side rail hooks (Fig. 5. ①) are locked by the cradle side plate (Fig. 5. ②).

⚠ CAUTION

Never enter under the breaker.
The breaker may fall and cause serious injury.
Do not push hard the breaker.

- With position lock release button (Fig. 4. ⑤) pushed, connect drawing in/out handle to the shaft.
- Then, when position lock release button (Fig. 4. ⑤) is pushed, it maintains self holding and allows draw-in/out handle (Fig. 4. ①) operation.
- To move the breaker to CONNECTED or TEST position, rotate draw-in/out handle in a clockwise direction.
With the breaker moving, if position indicator is accessing TEST position, position release button (Fig. 4. ⑤) is automatically pushed out and it locked draw-in/out handle.
When the handle is locked, do not rotate excessively. This may cause damage to the breaker.
- In the TEST position, with the handle stick, PUSH position release button (Fig. 4. ⑤) again and release draw-in/out handles.
- With position lock release button pushed, it maintains self holding, rotate draw-in/out handle in a clockwise direction again.
- Main circuit connection starts just before CONNECTED position, draw-in/out handle operation will become heavy.
But continue the rotating by adding force until, position indicator (Fig. 4. ⑥) of the breaker shows CONNECTED and, position release button (Fig. 4. ⑤) is automatically pushed out to lock the draw-in/out handle.
Then, remove draw-in/out handle and fix it on the right side of draw-out cradle.
- In CONNECTED position, do not operate draw-in/out handle in a clockwise direction. This may cause damage to the breaker.
- When the breaker fixing block is fitted, tighten left and right fixing screw by draw-in/out handle.
- In order to control the breaker electrically, you should connect all circuit according to the diagram on page 44-45.

05 Periodic Inspection and Parts Replacement

Period of periodic inspection

It is most appropriate that the user works out his or her own inspection plan for the breakers according to the switching frequency, the value of normal breaking and making currents, the magnitude of the fault current interrupted, service conditions, and environmental conditions.

It is recommended to perform a simplified inspection once every 6 months and a full inspection once every 12 months.

To perform an periodic inspection, draw out to ISOLATED position or move out of draw-out cradle.

Mechanical durability life of the breaker

The following table shows the mechanical durability of the breaker for Maximum Warranty Life.

When accumulated counting number of switching cycles exceeds those shown, we recommend you check the breaker.

For renewal or thorough inspection, please contact us.

Frame Size	Below 2,500 AF	Above 3,200 AF
of switching cycle	Total : 3,000 (Mechanical : 2,500, Electrical : 500)	Total : 2,000 (Mechanical : 1,500, Electrical : 500)

Frequency of inspection

Frequency of inspection is considered with service condition and switching numbers, breaking/making current value, but it is recommended to perform a simplified inspection once every 6 months and a full inspection once every 12 months.

Inspection by switching numbers

Switching Conditions of ACB	Inspection Interval Based on Switching Cycles		
	Below 1,000 AF	1,250-2,500 AF	Above 3,200 AF
Switching operation in the state of nearly no-carrying current	1,000	1,000	1,000
Switching operation in the rated current region	500	500	100
Switching operation in overload region (about 2-3 times the rated current)	25	25	10
Switching operation in current interruption region	each time	each time	each time

CAUTION

Draw out the breaker to the ISOLATED position or remove the breaker body from the draw-out cradle for inspection or parts replacement purposes.

Make sure that residual heat of terminal should be cooled down before performing inspection work.

Unless it may cause burn.

5.1 Arc Chamber

Check each arc chamber during the periodic inspection and also, after a fault current take place.

A cracked arc chamber cover or de-ionized grid side plate, or a heavy, hard-to-remove molten contact or de-ionized pieces inside of the arc chamber, requires replacement of the arc chamber unit.

1) Periodic inspection

Inspection Item	Method / Criteria
Dirt, dust, foreign matter	Check visually. Inside must be clean, free of foreign matter and dust. Blow off foreign matter and dust with a jet of compressed air.
Cracks	Check visually. There should be no cracks or other damage.

2) Removal and mounting

Loosen the two-mounting screws on the arc chamber cover until they are free. Remove the arc chamber cover and nut.

To mount the arc chamber, set nut and arc chamber in position and tighten with two-mounting screws on the arc chamber cover.

⚠ CAUTION

Do not perform on-off operation with the nut installed after removing arc chamber, or it may slip into contact unit.

To mount the arc chamber, check square nut, place the arc chamber in position and tighten fixing screw (dish M6).

Fig. 6

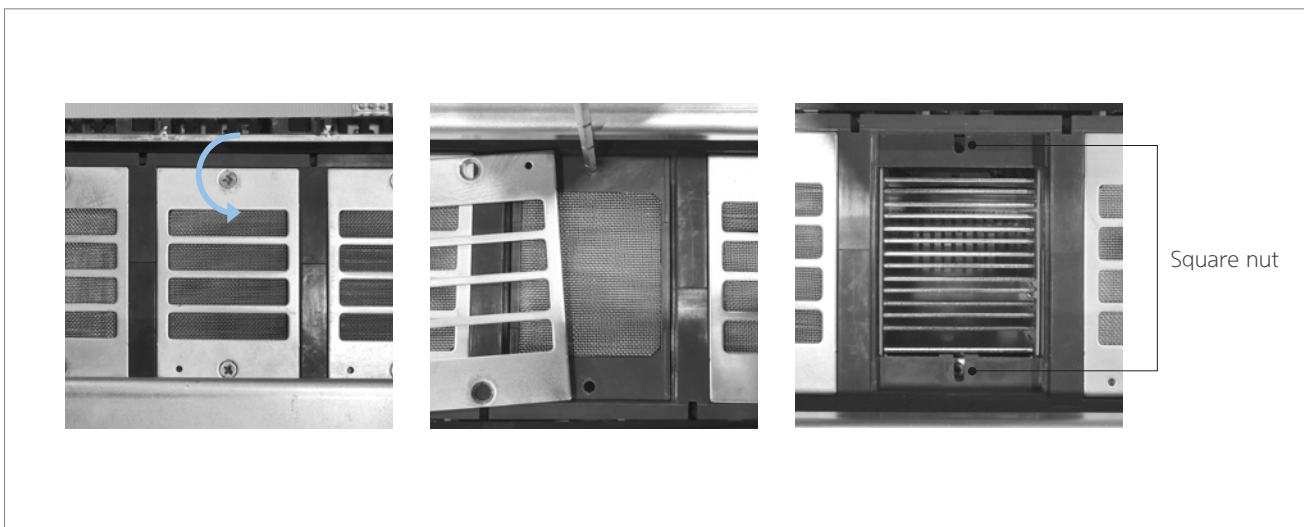

05 Periodic Inspection and Parts Replacement

5.2 Contact Unit

Contact unit are visible and accessible when the arc chamber is removed.

Check the contact unit during a periodic inspection and after a short-circuit fault current take place.

Fig. 7

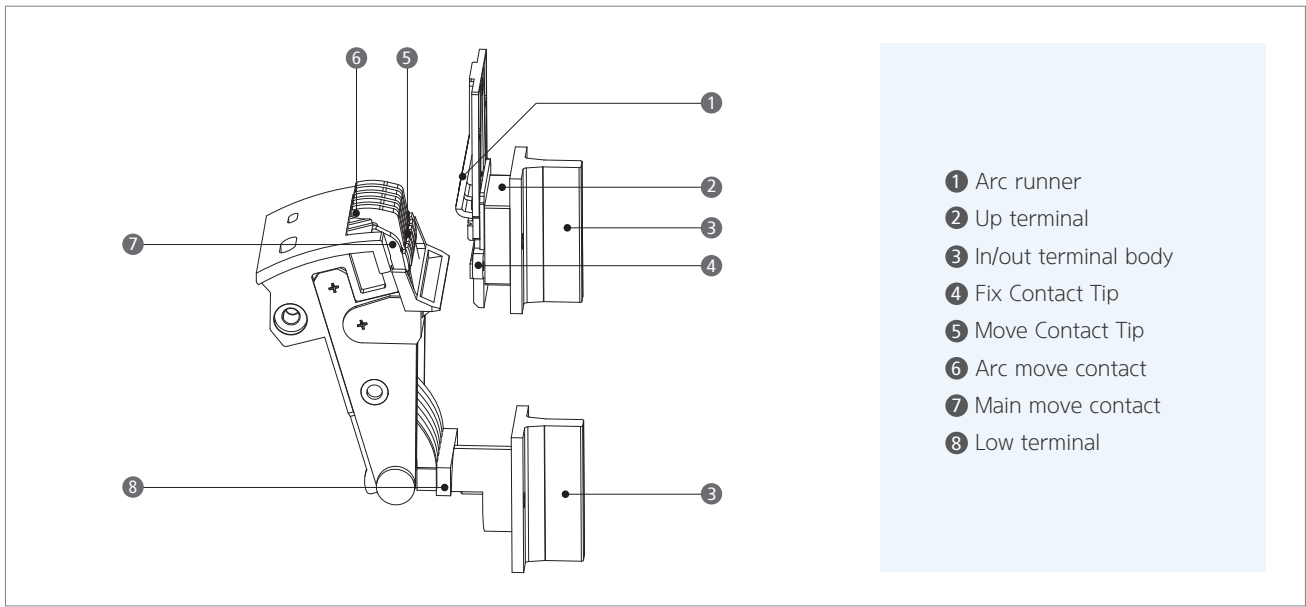

1) Periodic inspection

(1) Arcing contact

Inspection Item	Method / Criteria
Contact tip surface	<ul style="list-style-type: none"> - Check visually. - Melting mark in the contact point tip surface is not a problem because it is a normal phenomenon by close-open arc. - Remove dirt, dust, grease, etc. - When the arcing contact is melted less than 33 % original thickness, it should be replaced. For replacements, please contact us.

(2) Main contact

If contact surface is badly worn or become rough, you should clean the surface in case of periodic inspection.

CAUTION

When scrubbing contact trips' surface, pay attention to not let dust fall into the breaker mechanism. After dressing, be sure to wipe and clean contact trips.

5.3 Operating Mechanism

Fig. 8

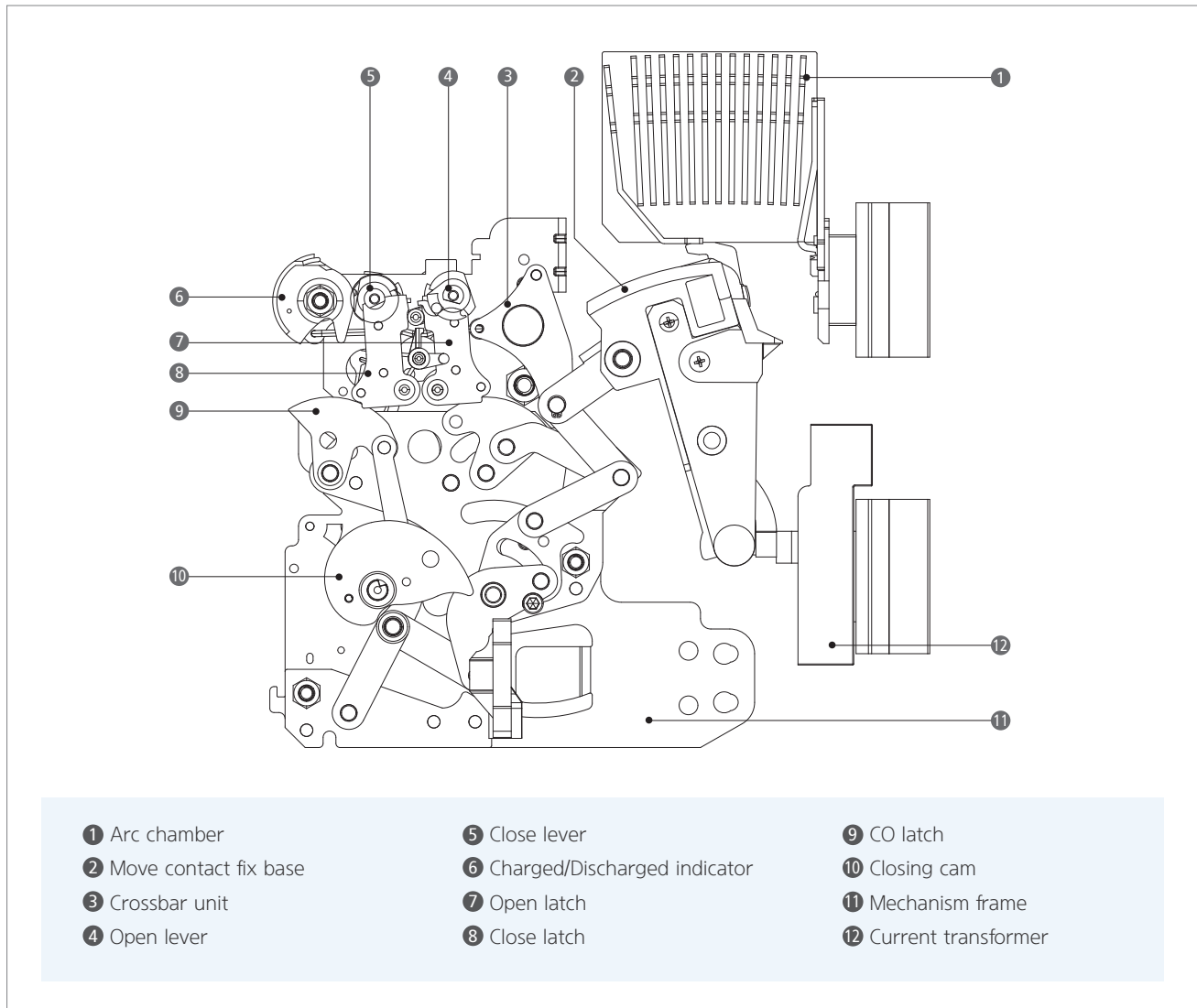

1) Periodic maintenance

Check the operating mechanism in detail as much as possible.

If there are parts that seem to be checked or hard to check, please contact us.

Inspection Item	Method / Criteria
Operation	Open and close breaker through manual control to check the mechanical parts for normal operation (every six months).
Lubrication	Add a small amount of grease to each of the pins, shafts and their bearings (every six months). Avoid excessive oiling to prevent the accumulation of dirt and dust.
Screws, bolts and springs	Check screws and bolts on each part for signs of loosening. Tighten them if loose. Check each spring for proper engagement and damage. Correct problem through repair or replacement (every six months).
Dirt and dust	Latching parts should be free of dirt and dust. Wipe them with a clean cloth (every six months).

05 Periodic Inspection and Parts Replacement

5.4 Internal Accessories

Loosen the two front cover mounting screws and open the front cover (Fig. 1. ②) to check internal accessories.

CAUTION

Do not place your fingers or a tool in the gap between close/open and charged/discharged indicator (Fig. 9. ⑥, ⑫) since this gap is closed when the breaker is closed.

Do not attempt to put hand or a tool into the breaker when closing springs are charged.

Be sure to discharge the closing springs prior to internal inspection.

Do not operate the on-off operation arbitrarily (qualified personnel only).

Fig. 9

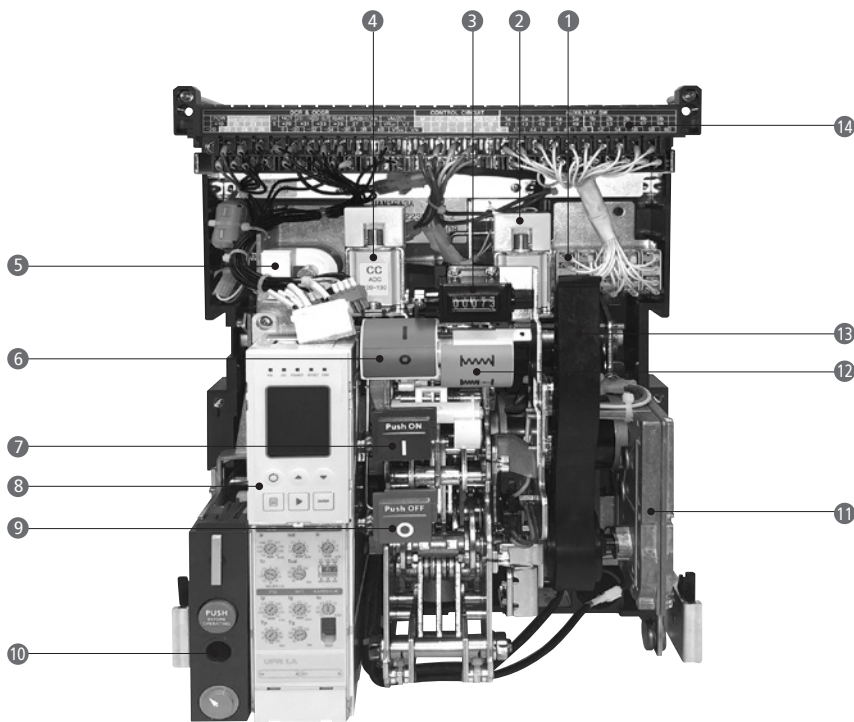

- | | | |
|-------------------------------|----------------------------|-------------------------------------|
| ① Auxiliary switch | ⑥ Close/Open indicator | ⑪ Spring charging motor |
| ② Shunt (SHT) | ⑦ Close button | ⑫ Charged/Discharged indicator |
| ③ Cycle counter | ⑧ Over current relay (GPR) | ⑬ Manual charging handle |
| ④ LRC (latch release coil) | ⑨ Open button | ⑭ Automatic connection control jack |
| ⑤ MHT (magnetic hold trigger) | ⑩ Device of drawing in/out | |

1) Shunt trip device (SHT)

Rated Voltage		Coil Resistance
AC/DC	110	40 $\Omega \pm 5\%$
	220	68 $\Omega \pm 5\%$
AC	380	250 $\Omega \pm 5\%$
	440	250 $\Omega \pm 5\%$
DC	24	7 $\Omega \pm 5\%$
	48	11.8 $\Omega \pm 5\%$

(1) Periodic inspection (Fig. 21. reference)

Inspection Items	Methods / Criteria / Dispositions
Operation	<ul style="list-style-type: none"> - Push the moving core of SHT with a pointed tool, such as a screwdriver trip, then, slowly release the core. The result is acceptable if the core returns lightly. - Push in the moving core slowly after closing the breaker. The result is acceptable if breaker trips open. - The result is acceptable, if the breaker trips open at less than 70 % of the rated voltage after closing the breaker.
Coil	<ul style="list-style-type: none"> - Measure the coil resistance with an ohmmeter. If it is much lower than the value shown in table or there is no continuity, replace the coil.
Terminals and mounting screws	- Check terminals and mounting screws. Tighten them if loose.

Fig. 10. Shunt trip equipment mounting

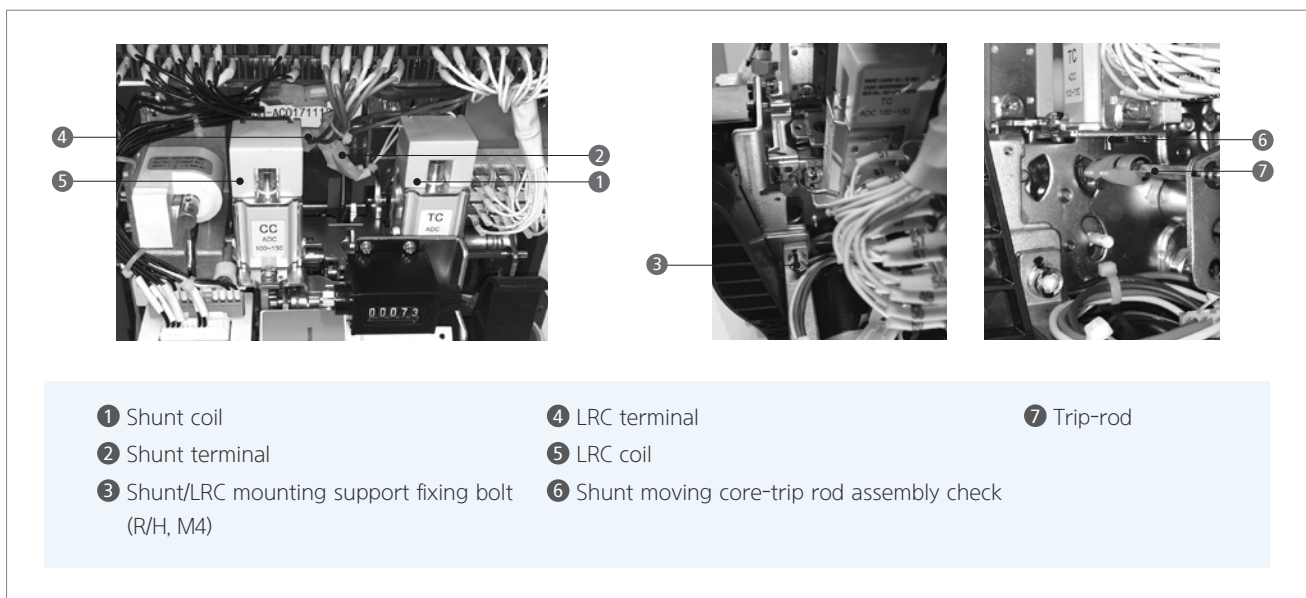

(2) Replacement of SHT (Fig. 10)

- Remove the two pin terminal from the control jack terminals (Fig. 10. ②).
- Remove the one support mount screws (Fig. 10. ③) and take out LRC-UVT-SHT support.
- Remove the coil mount screws (Fig. 13. ③).
- A new coil is properly assembled, and during attaching it. The trip-rod and shunt moving core position is shown as in Fig. 10. ⑥, ⑦.
- After checking the light movement of the moving core of new SHT, mount it in the breaker as it was.
- Connect the two pin terminal to the control jack terminals, and test the ACB and trip lever both electrically and mechanically for normal operation (number 7, 8).

05 Periodic Inspection and Parts Replacement

2) Undervoltage trip device (UVT)

- UVT coil uses only DC rating.
- The under-voltage trip device includes instantaneous trip type and time delay trip type having 0.5 sec, 1 sec, 1.5 sec and 3 sec time delay characteristics.

(1) General view of undervoltage trip coil & controller (time delay trip type)

Fig. 11. UVT coil & UVT controller (only time delay type applied)

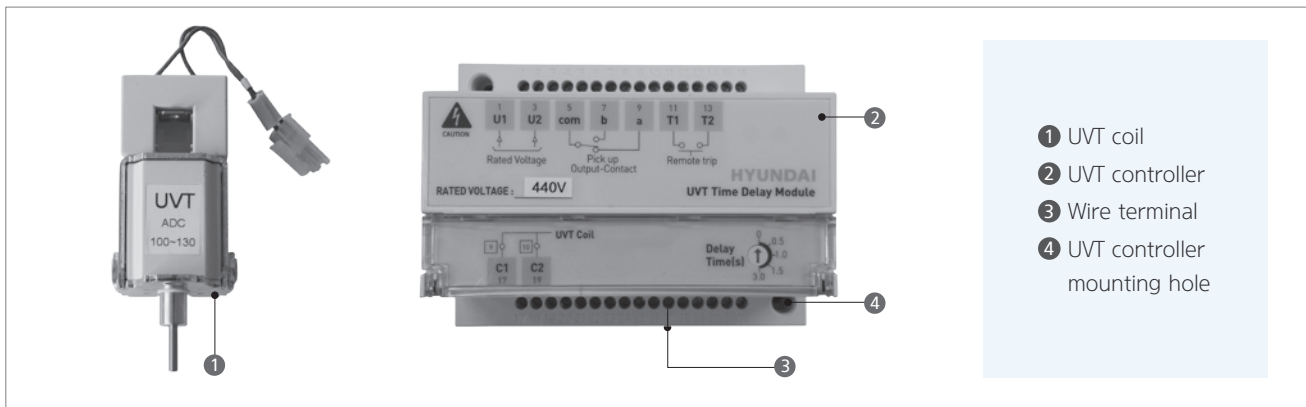

(2) Periodic inspection

Inspection Items	Methods / Criteria / Dispositions	
Operation	- The breaker can not be closed when the UVT is de-energized. Because of this, if the breaker can be closed at more than 85 % of the rated voltage, moving core becomes pick-up, the result is acceptable. - If the breaker can be tripped from 35 % to 70 % of the rated voltage after closing the breaker, the result is acceptable.	
Coil resistance	- Measure the coil resistance with an ohmmeter. If the measured resistance is much lower than the value shown in the right or there is no continuity, replace the UVT coil.	Coil resistance (Ω) 118 Ω \pm 5 %
Terminals and mounting screws	- Check terminals and mounting screws for loosening. Retighten them if loose.	

(3) Replacement of UVT controller

When it is necessary to replace the UVT controller, replace the whole UVT controller unit.

- Remove the UVT wire at the wire terminal (Fig. 11. ①).
- Remove UVT mounting bolt (2-M6x10) (Fig. 11. ④).
- Take out the UVT controller.
- Install new UVT controller as it was on the breaker with UVT mounting bolt (Fig. 11. ④).
- Connect the wire terminals with fasten terminals at the same time.
- Test the UVT both electrically and mechanically.

⚠ CAUTION

When inspecting the performance, rated voltage should be supplied unless ACB will not operate.

⚠ CAUTION

Recheck the wire terminal before supplying power.
 Incorrect wiring may cause coil burning.

3) Latch release coil (LRC)

Coil resistance is same with SHT.

(1) General view of latch release coil (LRC)

Fig. 12

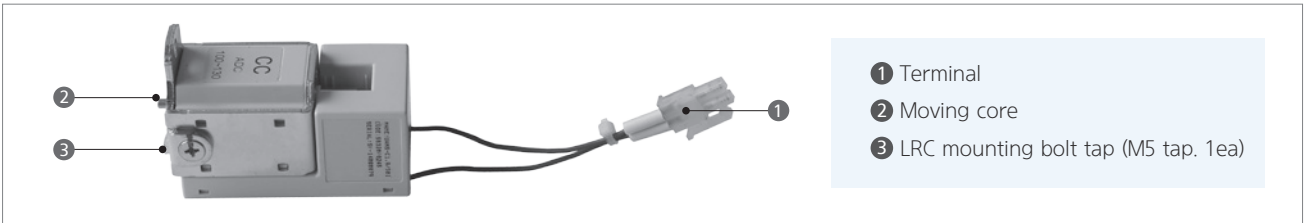

- ① Terminal
- ② Moving core
- ③ LRC mounting bolt tap (M5 tap. 1ea)

(2) Periodic inspection

Inspection Items	Methods / Criteria / Dispositions
Operation	<ul style="list-style-type: none"> - Push the moving core with a pointed tool, such as a screwdriver tip, then, slowly release the core. The result is acceptable if the core returns lightly. - Charge the closing springs and push the moving core. The result is acceptable if the closing springs are discharged. - If the breaker can be closed at 35 % of the rated voltage, the result is acceptable.
Coil resistance	<ul style="list-style-type: none"> - Measure the coil resistance with an ohmmeter. If resistance was much lower than the value shown in table.1 (page 19) or there is no continuity, replace the CC.
Terminals and mounting screws	<ul style="list-style-type: none"> - Check terminals and mounting screws for loosening. Tighten them if they are loose.

(3) Replacement of LRC (unit replacement)

- Remove the pin terminal from the control jack terminals (Fig. 10. ④).
- Remove support mounting screw (Fig. 13. ②) M4, and take out the LRC-UVT-SHT support.
- Remove coil mounting screw (Fig. 13. ②).
- After checking the movement of the new LRC moving core, mount it in the breaker as it was.
- Connect the pin terminal to the control jack terminals (Fig. 10. ④).
- Test the device both electrically and mechanically for normal operation in the same manner described in periodic inspection table.

⚠ CAUTION

Take care when checking on/off operation by using mechanism manual button.
Fingers may be pinched during operation.

Fig. 13

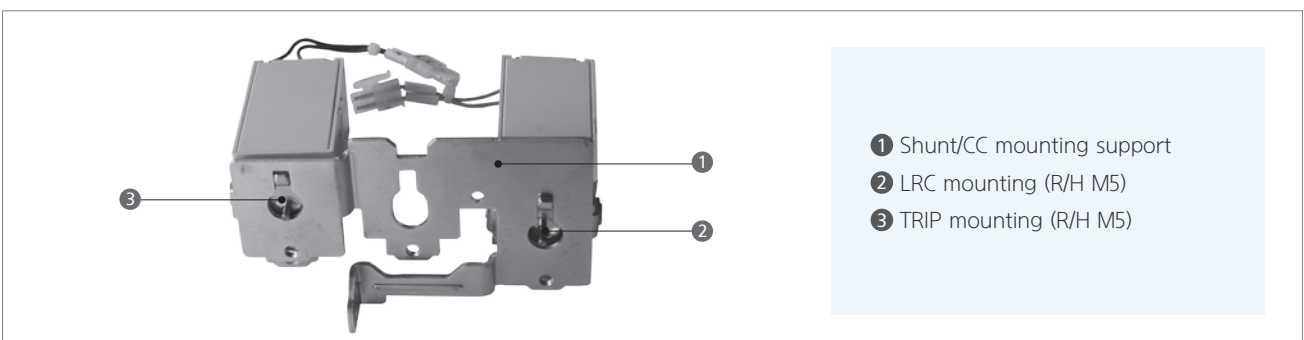

- ① Shunt/CC mounting support
- ② LRC mounting (R/H M5)
- ③ TRIP mounting (R/H M5)

05 Periodic Inspection and Parts Replacement

4) Auxiliary switch unit

(1) General view of auxiliary switch unit, connection circuit

Fig. 14. Aux. switch general view



Fig. 15. Aux. switch connection circuit

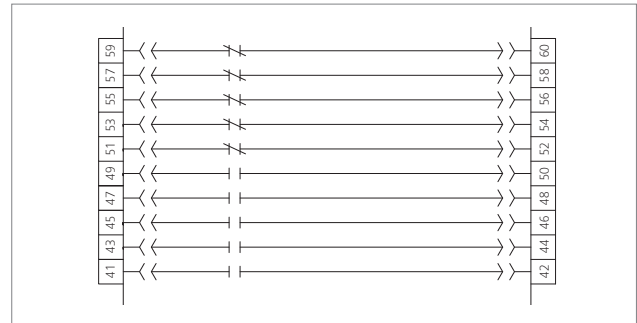

(2) Periodic inspection

Inspection Items	Methods / Criteria / Dispositions
Operation	<ul style="list-style-type: none"> - Take the breaker body out of the cradle. - Connect the ohmmeter or alarm (buzzer) to each switch element. - Check that a-contact is ON and b-contact is OFF when breaker is CLOSED, and that a-contact is OFF and b-contact is ON when breaker is OPEN.
Contact surface	<ul style="list-style-type: none"> - If contact is excessively worn or rough, replace whole switch unit.
Terminals and mounting screws	<ul style="list-style-type: none"> - Check terminals and mounting screws. Tighten them if loose.

(3) Replacement of auxiliary switch unit (Fig. 17)

The auxiliary switch unit is an assembly of 10 circuits (5 a-contacts and 5 b-contacts).

Replace the whole switch unit even if there is a partial defect.

- Remove the auxiliary switch assembly bolt (1-M6 wrench bolt) (Fig. 14. ①).
- Change wire circuit.
- Tighten the auxiliary switch assembly bolt (1-M6 wrench bolt).
- Conduct periodic inspection mentioned in (2) above and make sure if the switch operates normally.

⚠ CAUTION

Replaced terminal must be properly connected before operating.

5) Motor unit

(1) Motor unit general view

Fig. 16

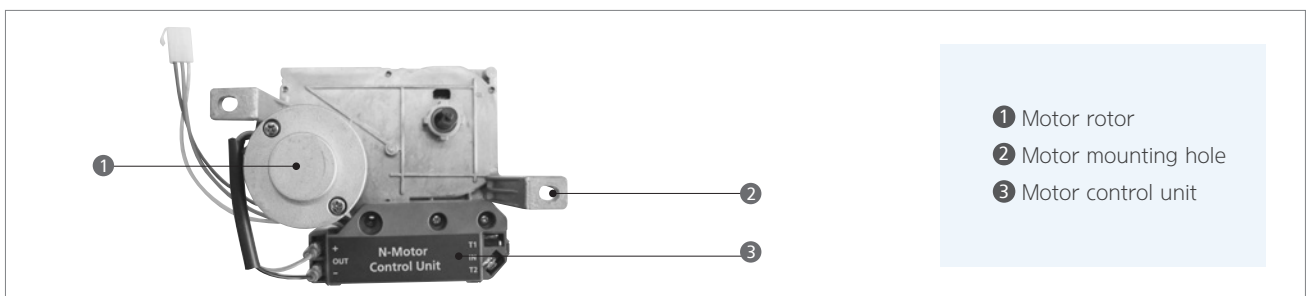

(2) Operation check

Open and close the breaker through electrical control to check the relay for normal operation.

Do this in the following procedure.

- After checking front-cover, with the push-button switch ON, close the breaker.
- Normal operation is when the breaker is closed, the motor is rotating and the charged/discharged indicator displays 「」.

(3) Replacement of motor control unit

- Open the ACB.
- Draw-out the breaker body out of draw-out cradle.
- Remove front cover.
- Remove both motor cables (1, 2 terminal) and control jack terminal.
- Release motor fixing bolt (2-M6 wrench bolt, Fig. 17. ①).
- Remove motor from the breaker.
- Remove motor connection terminal (Fig. 17. ②).
- After checking new motor unit, replace, and follow steps 4-7 in reverse.
- Charging motor is originally placed position of the breaker.
- Attach front cover.
- Check the operation according to operation check (2).

⚠ CAUTION

Replaced line terminal must be properly connected before operation.

Fig. 17

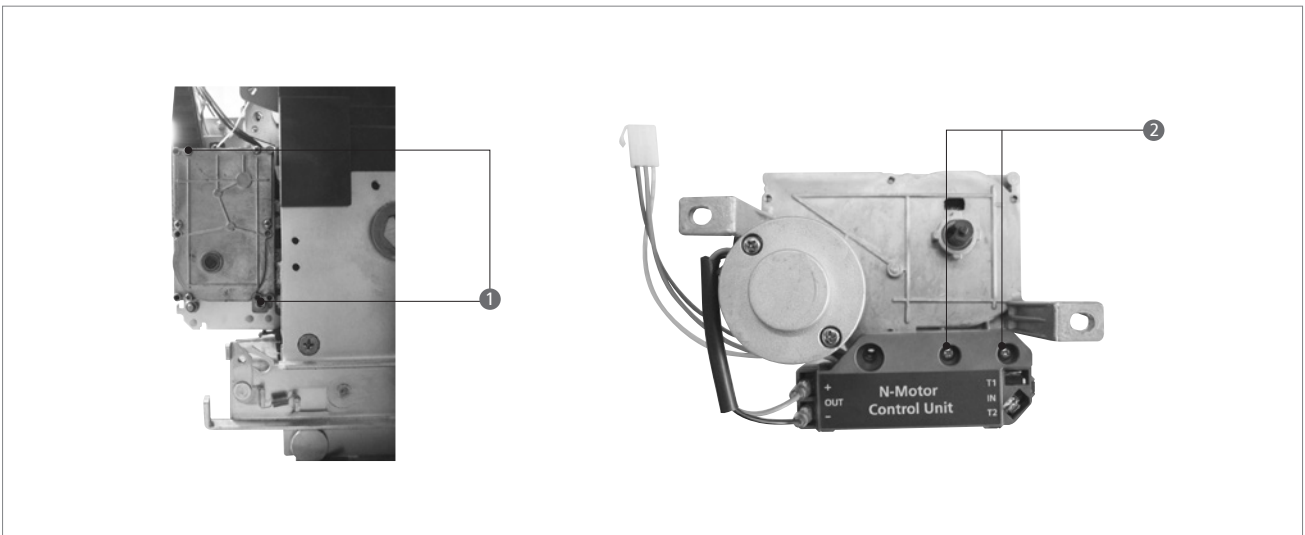

6) Direction of ACB position padlock device

- Purpose: Position padlock device is designed for locking ACB body at three positions (ISOLATED, TEST, CONNECTED) by a shackle.
- Usage: At any position, pull out position padlock plate and attach the shackle (user supplied).

⚠ DANGER

Do not draw out ACB when it is in the service states.
 Since main circuit is live, draw-out operation will cause fatal accident.
 Check the breaker is opened before operating draw-in/out.

06 Protection Relay - GPR

Fig. 18

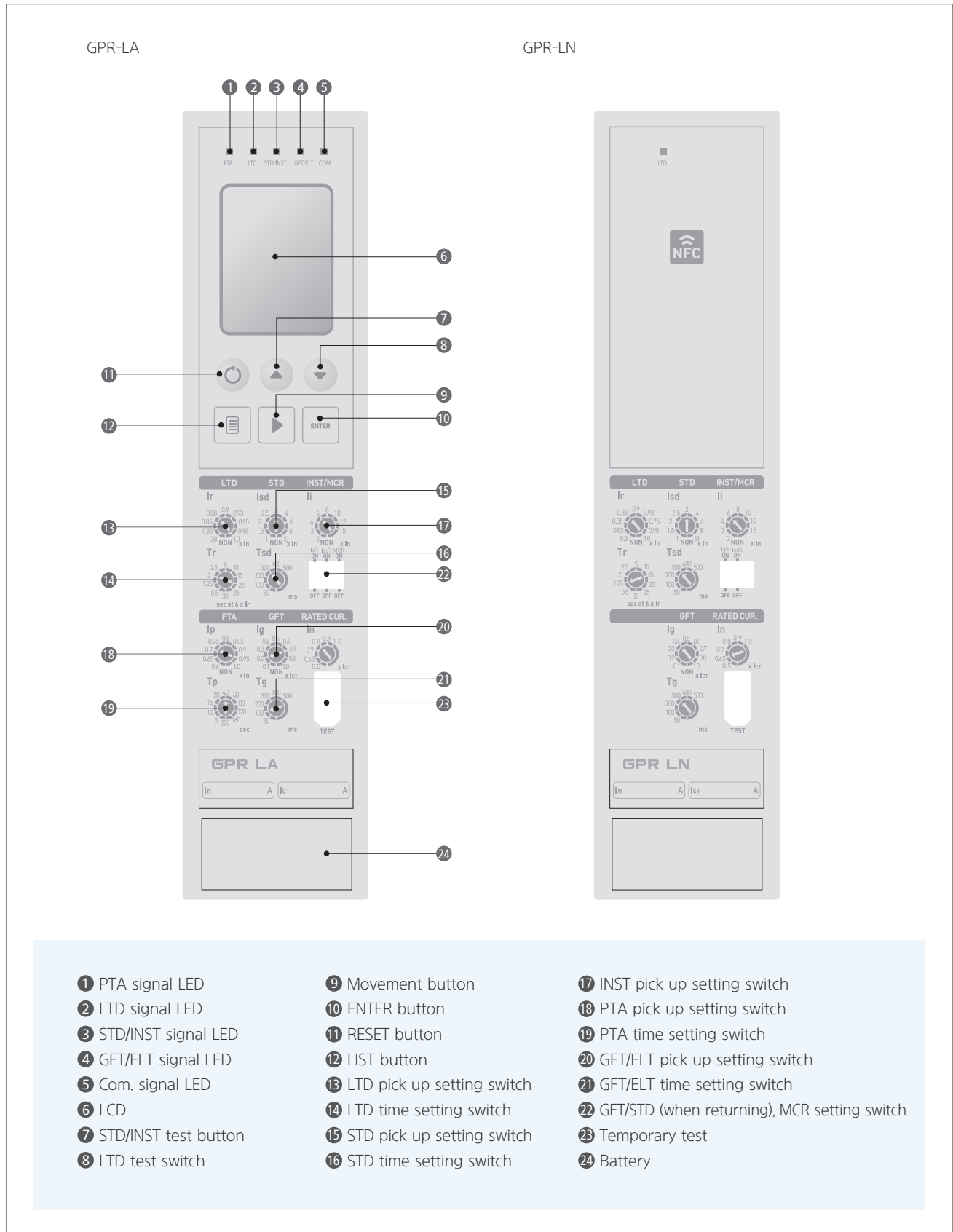

- | | | |
|------------------------|-------------------------------|---|
| 1 PTA signal LED | 9 Movement button | 17 INST pick up setting switch |
| 2 LTD signal LED | 10 ENTER button | 18 PTA pick up setting switch |
| 3 STD/INST signal LED | 11 RESET button | 19 PTA time setting switch |
| 4 GFT/ELT signal LED | 12 LIST button | 20 GFT/ELT pick up setting switch |
| 5 Com. signal LED | 13 LTD pick up setting switch | 21 GFT/ELT time setting switch |
| 6 LCD | 14 LTD time setting switch | 22 GFT/STD (when returning), MCR setting switch |
| 7 STD/INST test button | 15 STD pick up setting switch | 23 Temporary test |
| 8 LTD test switch | 16 STD time setting switch | 24 Battery |

GPR is a CPU loaded, high-reliability, multifunctional protection relay for HG-Series ACB. This protection relay is classified into types GPR-1L, 2L (for general feed circuits) and type GPR-1S, 2S (for generator protection).

Refer to the following protective function combination table.

Protective function combination table

Protective Function	Indication Contact	Control Power Supply	GPR Multifunction Protective Device	
			For General Feeder Circuits	For General Protection
AL — AS — AI — AG	IU		GPR-LN	-
AL — AS — AI — AP — MCR — AG	CP/I	Needed	GPR-LA	-
AL — AS — AI — AP — MCR — AG — ELT	CP/I	Needed	GPR-LAG	-
AL — AS — AI — AP — AG — ELT	CP/I	Needed	GPR-LAZ	-
AL — AS — AI — AP — MCR — AG	CP/I	Needed	GPR-LP	-
AL — AS — AI — AP — MCR — AG	CP/I	Needed	GPR-LH	-
AL — AS — AI — MCR	IU		-	GPR-SN
AL — AS — AI — AP — MCR	CP/I	Needed	-	GPR-SA
AL — AS — AI — AP — MCR	CP/I	Needed	-	GPR-SP

Type GPR-LA, LAG, LAZ, LP, LH, SA, SP OCR is LCD display type.

- IU** Contact for operation indication
- AS** Instantaneous trip
- CP/I** Tripped LED indicator and contact
- AI** Ground fault trip
- AL** Long time delay trip
- AG** Function is an option
- AP** Pre-trip alarm
- MCR*** Making current release (option)
- ELT** Short time delay trip

* The function check is provided in GPR protection relay with CP-I, allowing a simple field test.

06 Protection Relay - GPR

6.1 Rated Current

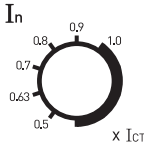
Type	Rated Current [I _n]
GPR-L type	<ul style="list-style-type: none"> - Rated current [I_n] can be adjusted to 50 %, 63 %, 70 %, 80 %, 90 %, and 100 % of the rated primary CT current [I_{CT}]. - On the GPR nameplate, rated current [I_n] is marked. - Rated current [I_n] can be selected by sliding the base current setting select switch, which can be set to the predetermined scale. 
GPR-S type	<ul style="list-style-type: none"> - A proper CT is selected according to the rated current [I_{GEN}] of generator. - Rated current [I_n] is adjusted to be equal to the rated current value [I_{GEN}] of generator by the rotary switch inside GPR-S. - Accordingly, the rated current value [I_{GEN}] of generator corresponds to rated current [I_n]. - On the GPR nameplate, rated current [I_n] is marked.

6.2 Protective Functions and Setting Ranges

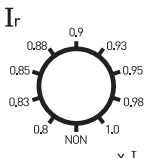
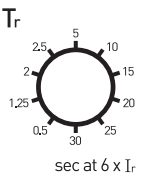
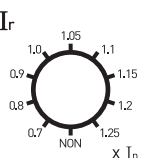
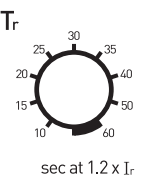
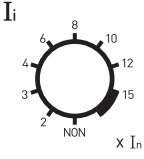
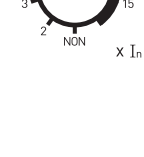
Protective Function	Current Setting Range	Time Setting Range
LTD trip (I _r , T _r)	Type GPR-L  <ul style="list-style-type: none"> - The scale is marked as magnification of [I_n]. - Current setting range is 10 steps (Non, 0.8, 0.83, 0.85, 0.88, 0.9, 0.93, 0.95, 0.98, 1.0) times of [I_n]. - When [I_r] is set to NON the protective function, it does not operate. - The breaker is not tripped at less than 105 %, and tripped at more than 120 % of [I_r] setting. 	 <ul style="list-style-type: none"> - The setting dial is scaled in a few seconds, which is the operating time at 600 % of [I_r] setting. - Time setting range is 10 steps of 0.5, 1.25, 2, 2.5, 5, 10, 15, 20, 25, and 30 seconds. - The breaker is tripped at the range from -15 % to +15 % of time setting range.
	Type GPR-S  <ul style="list-style-type: none"> - The scale is marked as magnification of [I_n]. - Current setting range is eight steps (NON, 0.7, 0.8, 0.9, 1.0, 1.05, 1.1, 1.15, 1.2, 1.25) of [I_n]. - When [I_r] is set to NON the protective function, it does not operate. 	 <ul style="list-style-type: none"> - The setting dial is scaled in a few seconds, which is the operating time of current flow at 120 % of [I_r] setting. - Time setting range is nine steps of 10, 15, 20, 25, 30, 35, 40, 50, and 60 seconds (error extent is 5 %).
INST trip (I _i)	Type GPR-L  <ul style="list-style-type: none"> - The scale is marked as magnification of [I_n]. - Current setting range is nine steps (NON, 2, 3, 4, 6, 8, 10, 12, 15) of [I_n]. - When [I_i] is set to NON the protective function, it does not operate. 	- Time setting is unnecessary.
	Type GPR-S  <ul style="list-style-type: none"> - The scale is marked as magnification of [I_n]. - Current setting range is nine steps (NON, 2, 3, 4, 6, 8, 10, 12, 15) of [I_n]. - When [I_i] is set to NON the protective function, it does not operate. 	

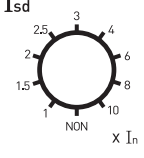
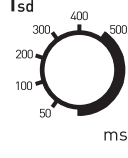
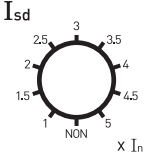
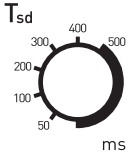
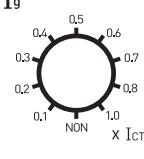
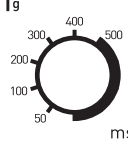
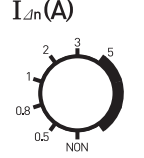
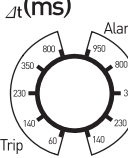
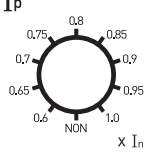
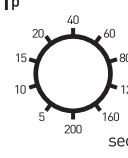
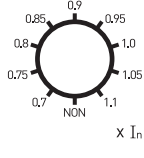
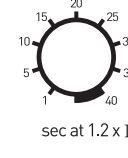
Protective Function		Current Setting Range		Time Setting Range	
STD trip (I_{sd} , T_{sd})	Type GPR-L		<ul style="list-style-type: none"> - The scale is marked as magnification of [I_n]. - Setting dial is scaled in multiples of [I_n]. - There are ten discrete setting positions: NON, 1, 1.5, 2, 2.5, 3, 4, 6, 8, 10 times [I_n]. - When [I_{sd}] and [I_l] are set at NON, the device is operated at 1,000 % of [I_n] setting as a fail-safe function by [T_{sd}] setting. 		<ul style="list-style-type: none"> - Setting dial is scaled in milliseconds, which is the operating time at current flow higher than [I_{sd}] 120 % setting. - There are six discrete 50, 100, 200, 300, 400, 500 milliseconds.
	Type GPR-S		<ul style="list-style-type: none"> - The scale is marked as magnification of [I_n]. - Setting dial is scaled in multiples of [I_n]. - There are nine discrete setting positions: NON, 1, 1.5, 2, 2.5, 3, 3.5, 4, 4.5, 5 times [I_n]. - When [I_{sd}] and [I_l] are set at NON, the device is operated at 500 % of [I_n] setting as a fail-safe function. 		<ul style="list-style-type: none"> - Setting dial is scaled in milliseconds, which is the operating time at current flow higher than [I_{sd}] 120 % setting. - There are six discrete setting positions: 50, 100, 200, 300, 400, 500 milliseconds.
GFT (I_g)	Type GPR-L		<ul style="list-style-type: none"> - The scale is marked as magnification of GPR rated primary current [I_{CT}]. - The current setting range is 10 steps (NON, 0.1, 0.2, 0.3, 0.4, 0.5, 0.6, 0.7, 0.8, 1.0 times [I_{CT}]). 		<ul style="list-style-type: none"> - Setting dial is marked as relay operation time. The mark is milliseconds. - The current setting range is six steps (50, 100, 200, 300, 400, 500 milliseconds).
ELT ($I_{\Delta t}$)	Type GPR-LAG		<ul style="list-style-type: none"> - The scales is marked as magnification of external CT (ZCT or Neutral line CT) rated secondary current (5A). - The current setting range is six steps (NON, 0.5, 0.8, 1, 2, 3, 5 A of [ZCT]). 		<ul style="list-style-type: none"> - If setting primary current is applying an electric current, two modes of alarm and trip are established. - Alarm setting range is five steps (140, 230, 350, 800, 950 milliseconds). - Trip setting range is five steps (60, 140, 230, 350, 800 milliseconds).
Pre-alarm (I_p)	Type GPR-L		<ul style="list-style-type: none"> - The scale is marked as magnification of GPR rated primary current [I_n]. - The current setting range is 10 steps methods (NON, 0.6, 0.65, 0.7, 0.75, 0.8, 0.85, 0.9, 0.95, 1.0 times [I_n]). 		<ul style="list-style-type: none"> - Setting dial is marked as relay operating time. The mark is seconds. - The current setting range is 10 steps (5, 10, 15, 20, 40, 60, 80, 120, 160, 200 seconds).
	Type GPR-S		<ul style="list-style-type: none"> - The scale is marked as magnification of GPR rated primary current [I_n]. - The current setting range is 10 steps methods (NON, 0.7, 0.75, 0.8, 0.85, 0.9, 0.95, 1.0, 1.05, 1.1 times [I_n]). 		<ul style="list-style-type: none"> - At 120 % of [I_n], nine steps are available (1, 5, 10, 15, 20, 25, 30, 35, 40 seconds).

06 Protection Relay - GPR

1) Method of changing protective function settings
 The settings of type GPR protection relay can be changed easily by dial operation.
 This section describes the basic procedures for setting the protective device.
 For setting details of individual protective functions see page 25-26.

(1) Basic procedures

- To release the GPR safety cover attached to the front of the ACB, insert a flat-head screwdriver (Fig. 19. ②) at hole of GPR safety cover (Fig. 19. ①).
- Adjust setting switches with a small flat-head screwdriver (Fig. 19. ②).
 GPR is composed of two setting switch.

Fig. 19

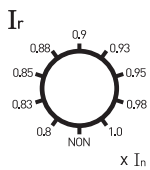

Rotary step switches

Rotate the dial until the arrow points to the desired position.
 The setting is the same within the scale range denoted by a bold line.

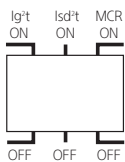

Slide switches

Slide the switch knob up/down to turn on/off.

- After adjustment, check a set point by using a test function and tester of GPR checker (optional item).

CAUTION

Do not apply excessive force to the switches.
 The switches should be turned lightly or slid with the screwdriver.

- Return the transparent GPR cover (Fig. 19. ①) to its original position.

(2) The setting of slide switch

- Ig²t ON/OFF

GFT time characteristic is divided into definite time and inverse time, it can be selected.

Ig²t ON/OFF

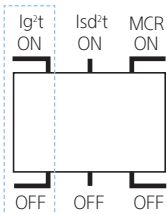

Ig²t OFF: For definite time characteristic
 Ig²t ON : For inverse time characteristic, which has Ig²t=C (constant) characteristic at 100 % of a set point, please refer to product catalogue for detail. Tolerance of setting current is ±30 %.

- Isd²t ON/OFF

STD time characteristic is divided into definite time and inverse time, it can be selected.

Isd²t ON/OFF

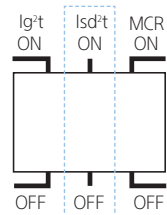

Isd²t OFF: For definite time characteristic
 Isd²t ON : For inverse time characteristic, which has Isd²t=C (constant) characteristic at 100 % of a set point, (500 % for marine application) please refer to catalogue for detail. Tolerance of setting current is ±20 %.

- MCR

MCR operates INST, when acb is closed, if the input current exceeds 8 times of the rated current. And after closing, it does not operate.

Please place the MCR switch on "ON" position in order to activate the MCR function.

※ MCR function is option (please refer to the ACB ordering form)

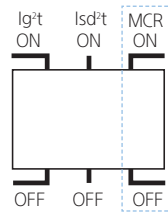

MCR ON/OFF



6.3 Operation Indication Functions

The operation indication function includes  contact for tripped indication (whole indication).

1)  contact for tripped indication (whole indication) (GPR-L, GPR-S)

- This contact output is one contact operating even when of LTD, STD, INST, or GFT operates.
- The contact output (Fig. 1. ) is transmitted between the terminals  and  of disconnecting device for control circuit.
- Rating of contact for tripped indication.

Rating	Nominal Switching Capacity (Resistive Load)	5A 277VAC
	Max. Switching Power (Resistive Load)	1.385VA
	Max. Switching Voltage	277VAC
	Max. Switching Current	5A
	Max. Switching Capacity (Reference Value)	100mA 5VDC

06 Protection Relay - GPR

- 2) CP/I LED light and contact for tripped indication (type GPR-LA, LAG, LAZ, LP, LH, SA, SP)
- Control power is required for tripped indication. Supply the following power between terminals ⑱ and ⑳ of control circuit disconnecting device (Fig. 1. ⑫).
 - AC 100-125 V / 10 VA or AC 200-250 V / 10 VA
 - DC 100-125 V / 10 W or DC 200-250 V / 10 W or DC 240 V / 10 W
- When LTD, STD or GFT operates, the LED lights for tripped indication (Fig. 18. ②, ③, ④) light up individually.
- At the same time, the contact signal ON is outputted individually between terminals ㉒-㉓ of control circuit disconnecting device (Fig. 1. ①).

Operation signal contact terminal (GPR-2L-GS)

㉒-㉓ : LTD contact terminal	㉒-㉔ : STD/INST contact terminal
㉒-㉔ : PTA contact terminal	㉒-㉕ : GFR/ELT contact terminal

- The LTD, STD and GFT tripped indications remain ON until the reset button (Fig. 18. ⑩) is depressed. Pressing the reset button for more than one second resets the ON state.
- LED light and contacts for Pre-trip alarm operation indication
 - The PTA pickup indication LED light (Fig. 18. ①) flickers at more than pickup current value [I_P]. At the same time, the contact signal ON is outputted between terminals ㉒-㉓ of control circuit.
 - The operation indication is automatically reset if the current of less than [I_P] is reached.

※ Push the reset button (Fig. 18. ⑩).

If the abnormality is temporary, such as noise, the LED will turn off. At that time, the control function returns to normal.

If the LED does not go off after pushing the reset button, some abnormality may occur. In this case, immediately contact to HE.

- Rating of contact for tripped indication

Rating	Nominal Switching Capacity (Resistive Load)	5A 277VAC
	Max. Switching Power (Resistive Load)	1.385VA
	Max. Switching Voltage	277VAC
	Max. Switching Current	5A
	Max. Switching Capacity (Reference Value)	100mA 5VDC

6.4 Field Test



- 1) Function check method
 - A simple check of operation for type GPR protection relay can be made with a HI/LOW button.

⚠ CAUTION

For function check of each protective function, draw out the breaker to the ISOLATED position, or take it out from the draw-out cradle. If making function check in the TEST position, confirm that there is no influence on the sequence. In state with load current, Field Test function is automatically off.

- Function check of the ground fault trip function is not possible (for ground fault trip function, portable GPR checker can be possible).
- 2) Necessity for function check
 - Stop watch.
 - A flat-head screwdriver
 - Control power supply: Use marking plate of type GPR multifunction protective device if test in the test position checks function, check whether control power supply ⑱ to ⑳ of control circuit short device (Fig. 1. ⑫).

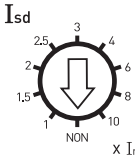
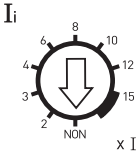
3) Protective function check

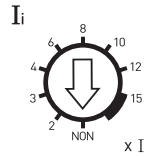
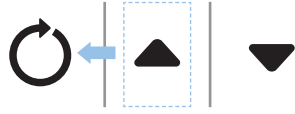
Protective Function	Type GPR-L (for general feeder circuit) / Type GPR-S (for generator protection)
LTD	<p>1. Close the breaker.</p> <p>2. In case of GPR-L, when short time delay and instantaneous time setting current value is lower than rated current, each dial should be in "NON" position using a flat-head screwdriver.</p> <div style="display: flex; justify-content: center; align-items: center;"> <div style="text-align: center; margin-right: 20px;">  <p>I_{sd}</p> </div> <div style="text-align: center;">  <p>I_i</p> </div> </div> <p>3. Push the "LOW" LOW Button (Fig. 18. ⑧) (current flow of 6 times the rated current [I_n] in type GPR-L, and 1.2 times the rated current in type GPR-S), and at the same time, measure the tripping time with a stopwatch. Also, hold the LOW Button until the breaker is tripped.</p> <div style="text-align: center; margin: 10px 0;">  </div> <p>4. After tripping, release the LOW Button. After tripping, reset the OCR by pushing the RESET button (Fig 18. ⑩)</p> <p>5. Read the tripped time. in case of type GPR-L, by flowing current (6 times of [I_n], 1.2 times of [I_n]), If it operates in allowable error of T_r setting time, it is normal.</p> <p>6. After the LCD test, short time delay and instantaneous time setting should be reset to original setting value by flat head screwdriver.</p>
STD	<p>1. Close the breaker.</p> <p>2. Instantaneous time trip setting current dial should set to NON position using a flat-head screw-driver.</p> <div style="text-align: center; margin: 10px 0;">  <p>I_i</p> </div> <p>3. Push the HIGH Button (Fig. 18. ⑦) to [HI] current flow of more than 15 times the rated current [I_n]. If the breaker is tripped with T_{sd} setting time, it is normal.</p> <div style="text-align: center; margin: 10px 0;">  </div> <p>4. After tripping, release the HIGH Button. Push the RESET button to OFF (neutral) automatically. Return the STD pickup current setting dial to the original set value with a flat-head screwdriver.</p>
INST	<p>1. Close the breaker.</p> <p>2. Push the test switch (Fig. 18. ⑦) to [HI] current flow of more than 15 times the base current [I_n]. If the breaker is tripped momentarily, it is normal.</p> <p>3. After tripping, release the test switch. After tripping, reset the OCR by pushing the RESET button (Fig 18. ⑩)</p>

06 Protection Relay - GPR

6.5 Characteristic Check

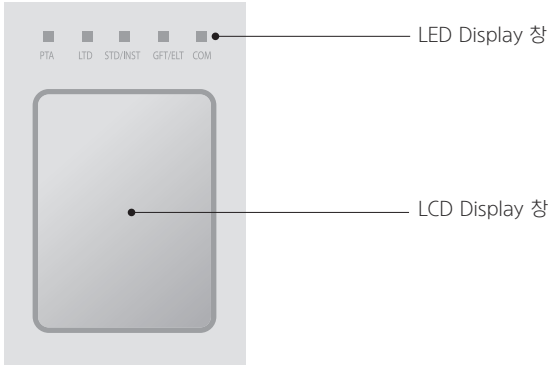
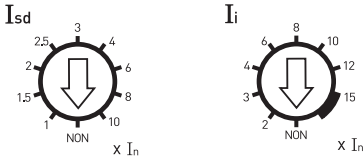
Protective Function	Type GPR-L (for general feeder circuit) / Type GPR-S (for generator protection)
<p>Pick-up current</p> <p>LTD</p>	<ol style="list-style-type: none"> 1. Close the breaker. 2. Input the current 1.2 times of the [I_r] setting current. LTD trip alarm LED (Fig. 18. ②) is flickering. The range of Pick-up allowable error is ± 10 %. 3. After checking for LED's flicker, off the test current. <div style="text-align: center;">  </div> <p>※ LCD display is not available for type GPR-LN and GPR-SN.</p>
<p>Trip time</p>	<ol style="list-style-type: none"> 1. Close the breaker. 2. In case of type GPR-L, when short time and instantaneous time setting current value are lower than 6 times of rated current, each dial using a flat-bladed screwdriver should set NON position. <div style="text-align: center;">  </div> <ol style="list-style-type: none"> 3. Type GPR-L and type GPR-S flow 6 times and 1.2 times current of [I_r] setting value separately. And at the same time, measure trip deadline as stopwatch or portable GPR checker. 4. The breaker is tripped in a range of ± 15 %, it is normal. 5. After checking trip operation, reset the OCR. 6. In case of operation of [2], short time delay and instantaneous time setting dial should be reset original setting value with a flat-head screwdriver.

Protective Function		Type GPR-L (for general feeder circuit) / Type GPR-S (for generator protection)																											
Short time delay trip characteristic check	Trip setting current	<ol style="list-style-type: none"> 1. Close the breaker. 2. Set long time and instantaneous time trip setting current dial to non using a flat-head screw-driver. <div style="display: flex; justify-content: space-around; align-items: center;"> <div style="text-align: center;"> <p>I_r</p> <p>x I_n</p> </div> <div style="text-align: center;"> <p>I_i</p> <p>x I_n</p> </div> </div> <ol style="list-style-type: none"> 3. Supply test current within ± 15 % of secondary voltage converted from [I_{sd}] setting current for type GPR-L. If the breaker trips, it is normal. In case of type GPR-S, test voltage is within ± 10 % of secondary voltage. 4. Reduce the test current to zero. 																											
	Trip time	<ol style="list-style-type: none"> 1. Close the breaker. 2. Set the test equipment output to 1.2 times the [I_{sd}] setting current. 3. Apply test voltage. At the same time, start the trip delay measurement with a stopwatch. 4. If the breaker is tripped, reduce the test voltage to zero. 5. Read the trip time. If the trip time is within the range of resettable time (ms) and maximum total clearing time (ms) shown in the table below, it is normal. <table style="margin-left: auto; margin-right: auto; border-collapse: collapse;"> <thead> <tr> <th style="text-align: left; padding: 5px;"><u>Time setting [T_{sd}] (ms)</u></th> <th colspan="6"></th> </tr> </thead> <tbody> <tr> <td style="padding: 5px;"><u>Six step system</u></td> <td style="text-align: center; padding: 5px;"><u>50</u></td> <td style="text-align: center; padding: 5px;"><u>100</u></td> <td style="text-align: center; padding: 5px;"><u>200</u></td> <td style="text-align: center; padding: 5px;"><u>300</u></td> <td style="text-align: center; padding: 5px;"><u>400</u></td> <td style="text-align: center; padding: 5px;"><u>500</u></td> </tr> <tr> <td style="padding: 5px;"><u>Resettable time (ms)</u></td> <td style="text-align: center; padding: 5px;"><u>35</u></td> <td style="text-align: center; padding: 5px;"><u>60</u></td> <td style="text-align: center; padding: 5px;"><u>150</u></td> <td style="text-align: center; padding: 5px;"><u>240</u></td> <td style="text-align: center; padding: 5px;"><u>330</u></td> <td style="text-align: center; padding: 5px;"><u>400</u></td> </tr> <tr> <td style="padding: 5px;"><u>Max. total clearing time (ms)</u></td> <td style="text-align: center; padding: 5px;"><u>120</u></td> <td style="text-align: center; padding: 5px;"><u>170</u></td> <td style="text-align: center; padding: 5px;"><u>270</u></td> <td style="text-align: center; padding: 5px;"><u>380</u></td> <td style="text-align: center; padding: 5px;"><u>480</u></td> <td style="text-align: center; padding: 5px;"><u>580</u></td> </tr> </tbody> </table> <ol style="list-style-type: none"> 6. Return the LTD/INST pickup current setting dial to the original set value with a flat-head screwdriver. 	<u>Time setting [T_{sd}] (ms)</u>							<u>Six step system</u>	<u>50</u>	<u>100</u>	<u>200</u>	<u>300</u>	<u>400</u>	<u>500</u>	<u>Resettable time (ms)</u>	<u>35</u>	<u>60</u>	<u>150</u>	<u>240</u>	<u>330</u>	<u>400</u>	<u>Max. total clearing time (ms)</u>	<u>120</u>	<u>170</u>	<u>270</u>	<u>380</u>	<u>480</u>
<u>Time setting [T_{sd}] (ms)</u>																													
<u>Six step system</u>	<u>50</u>	<u>100</u>	<u>200</u>	<u>300</u>	<u>400</u>	<u>500</u>																							
<u>Resettable time (ms)</u>	<u>35</u>	<u>60</u>	<u>150</u>	<u>240</u>	<u>330</u>	<u>400</u>																							
<u>Max. total clearing time (ms)</u>	<u>120</u>	<u>170</u>	<u>270</u>	<u>380</u>	<u>480</u>	<u>580</u>																							
INST	Trip setting current	<ol style="list-style-type: none"> 1. Close the breaker. 2. If the breaker doesn't trip at the test voltage of -20 % of secondary voltage converted from [I_i] setting current and trips at +20 % [I_i] setting current, it is normal. 																											

06 Protection Relay - GPR

Protective Function		Type GPR-L (for general feeder circuit) / Type GPR-S (for generator protection)																											
Pre trip alarm	Pick-up current	<ol style="list-style-type: none"> 1. Close the breaker. 2. Pre-alarm indicator LED (Fig. 18. ①) flickers when input the 100 % current of the $[I_n]$ setting value. In case of GPR-L/S Type, allowable error is $\pm 10 \%$. <div style="text-align: center; margin: 10px 0;">  </div> <ol style="list-style-type: none"> 3. Reduce the test current to zero. 																											
	Trip time	<ol style="list-style-type: none"> 1. Supply the specified control power. 2. Apply the test voltage of 1.1 times (GPR-L) and 1.2 times of (GPR-S) of secondary voltage levels the set value $[I_p]$ current. At the same time, start the time measurement with a stopwatch. <ul style="list-style-type: none"> - If the time at which an alarm signals is outputted across COM-PTA terminals is within the range of 20 % (GPR-L) and 15 % (GPR-S) of the set value $[T_p]$ second, it is normal. - Reduce of the test current to zero. 																											
GFT	Trip setting current	<ol style="list-style-type: none"> 1. Close the breaker. 2. Apply the test current of 10 % of the setting value $[I_a]$ current: If the breaker is tripped, it is normal. 3. Reduce the test current to zero. 																											
	Trip time	<ol style="list-style-type: none"> 1. Close the breaker. 2. Set the test equipment output to 120 % of the set value $[I_T]$ current. 3. Apply the test voltage. At the same time, start the trip delay measurement with a stopwatch. 4. If the breaker is tripped, reduce the test equipment output to zero. 5. Read the trip time. If the trip time value is within the range of resettable time (ms) and maximum total clearing time (ms) shown in the table below, it is normal. <table style="margin-left: auto; margin-right: auto; border-collapse: collapse;"> <tr> <td style="text-align: center;"><u>Time setting $[T_d]$ (ms)</u></td> <td></td> <td></td> <td></td> <td></td> <td></td> <td></td> </tr> <tr> <td style="text-align: center;"><u>Six step system</u></td> <td style="text-align: center;"><u>50</u></td> <td style="text-align: center;"><u>100</u></td> <td style="text-align: center;"><u>200</u></td> <td style="text-align: center;"><u>300</u></td> <td style="text-align: center;"><u>400</u></td> <td style="text-align: center;"><u>500</u></td> </tr> <tr> <td style="text-align: center;"><u>Resettable time (ms)</u></td> <td style="text-align: center;"><u>35</u></td> <td style="text-align: center;"><u>60</u></td> <td style="text-align: center;"><u>150</u></td> <td style="text-align: center;"><u>240</u></td> <td style="text-align: center;"><u>330</u></td> <td style="text-align: center;"><u>400</u></td> </tr> <tr> <td style="text-align: center;"><u>Max. total clearing time (ms)</u></td> <td style="text-align: center;"><u>120</u></td> <td style="text-align: center;"><u>170</u></td> <td style="text-align: center;"><u>270</u></td> <td style="text-align: center;"><u>380</u></td> <td style="text-align: center;"><u>480</u></td> <td style="text-align: center;"><u>580</u></td> </tr> </table>	<u>Time setting $[T_d]$ (ms)</u>							<u>Six step system</u>	<u>50</u>	<u>100</u>	<u>200</u>	<u>300</u>	<u>400</u>	<u>500</u>	<u>Resettable time (ms)</u>	<u>35</u>	<u>60</u>	<u>150</u>	<u>240</u>	<u>330</u>	<u>400</u>	<u>Max. total clearing time (ms)</u>	<u>120</u>	<u>170</u>	<u>270</u>	<u>380</u>	<u>480</u>
<u>Time setting $[T_d]$ (ms)</u>																													
<u>Six step system</u>	<u>50</u>	<u>100</u>	<u>200</u>	<u>300</u>	<u>400</u>	<u>500</u>																							
<u>Resettable time (ms)</u>	<u>35</u>	<u>60</u>	<u>150</u>	<u>240</u>	<u>330</u>	<u>400</u>																							
<u>Max. total clearing time (ms)</u>	<u>120</u>	<u>170</u>	<u>270</u>	<u>380</u>	<u>480</u>	<u>580</u>																							
Neutral protection	NON	<ol style="list-style-type: none"> 1. Set when switchboard system does not needs neutral pole protection. 2. It is only possible with control power supply type of OCR. 3. It is impossible with GPR-LN, SN type of OCR. 																											
	50n (@0.5 I_n)	<ol style="list-style-type: none"> 1. It operates at 50 % of I_n value. 2. LTD current of neutral pole is same as 50 % of I_r setting value. 3. STD current of neutral pole is same as 50 % of I_{sd} setting value. 4. INST operates at 100 % of I_i setting value. 5. It is impossible with GPR-LN, SN type of OCR. 																											
	100n (@ I_n)	<ol style="list-style-type: none"> 1. It operates at 100 % of I_n value. 2. LTD current of neutral pole is same as 100 % of I_r setting value. 3. STD current of neutral pole is same as 100 % of I_{sd} setting value. 4. INST operates at 100 % of I_i setting value. 5. For GPR-LN, SN type of OCR. It is basically set as 100 % 																											

6.6 Operating Manual for GPR-LA, LAG, LAZ, LP, LH, SA, SP Type

1) Simplicity test methods

LTD test

For LTD simplicity test, control source of GPR (AC/DC 110-220 V) is approved.

If you push continually low button, with PTA/LTD LED flickering, it starts perception

After time delay, LTD LED turning on, at the same time, LTD ground point is printed. ACB is open.

In order to remove printed ground point, after pushing reset button, all output LED is turned on and off. Also, the print contact point is removed.

STD/INST test

For STD/INST simplicity test, control source of GPR (AC/DC 110-220 V) is approved.

In case of STD/INST, if you push hi button, INST LED and ground point is printed. In case of INST/ NON, STD ground point is printed.

STD/INST accident signal and ground point is printed. ACB is open.

In order to remove printed ground point, after pushing reset button, all output LED is turned on and off. Also, the print contact point is removed.

2) The beginning screen

The beginning screen

If control source is applied, each phase load-current is automatically displayed in regular sequence of R-S-T-N. Under the rated 3 %, it marks "0".

In case of pickup setting switch change

In case of pick up setting switch adjustment, setting value is automatically displayed and after turning on back light, it is automatically turned off.

In case of time setting switch change

In case of setting switch adjustment, setting value is automatically displayed and after turning on back light, it is automatically turned off.

06 Protection Relay - GPR

3) Data check method



It explains relay menu and key operation method, setting method through window and example.

By using key panel below, it can use all menu of the relay.



There is a button saving list for checking setting data.



There is a button for moving data.



After moving to the item you want to know, there is a button for carrying out.

- List button (☰) - In case of pushing 1 time: Shows maximum current.

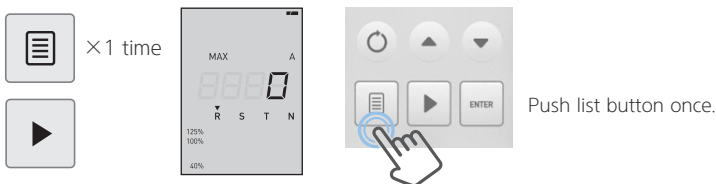

This mode shows phase with maximum current.

- List button (☰) - In case of pushing 2 times: Voltage confirmation (E type only)

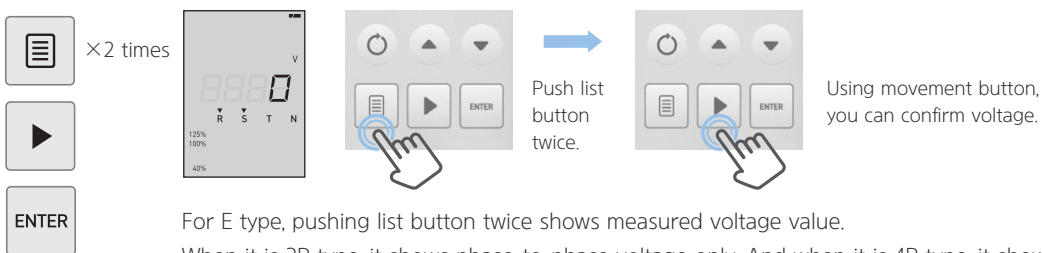

For E type, pushing list button twice shows measured voltage value.

When it is 3P type, it shows phase-to-phase voltage only. And when it is 4P type, it shows both phase-to-phase voltage and phase voltage. By pushing movement button you can check voltage value which you want.

- List button (☰) - In case of pushing 3 times: Power confirmation (E type only)



For E type, pushing list button 3 times shows measured power value. Each value shows each total for P, Q, S, PF in sequence. In case of negative PF value, positive value will be shown marked with R (reverse).

- List button (☰) - In case of pushing 4 times: Energy

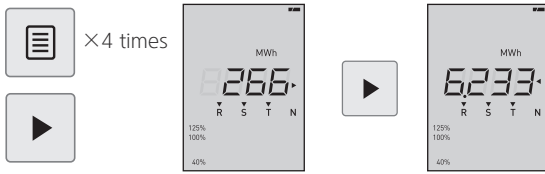

This mode shows active energy value.

Energy is shown in two screens. When there is remaining value, arrow will shown and you can move by movement button.

- List button (☰) - In case of pushing 5 times: Fault confirmation

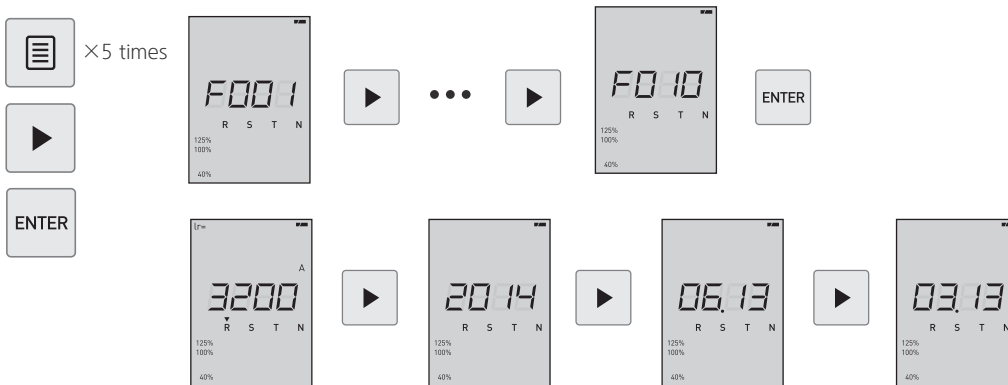

This is list checking accident record. The accident is stored in 10 data at this point in time, F001 is the newest. In case of data number exceeds, it is automatically deleted from the older data. Accidental contents, type-phase load current and accident occurrence time are stored, and you can confirm it by movement button.

Time information is shown in year, month, day, hour, minute in sequence. After choose data with movement button and then push enter button, you can check saved data.

- List button (☰) - In case of pushing 6 times: Set information confirmation.

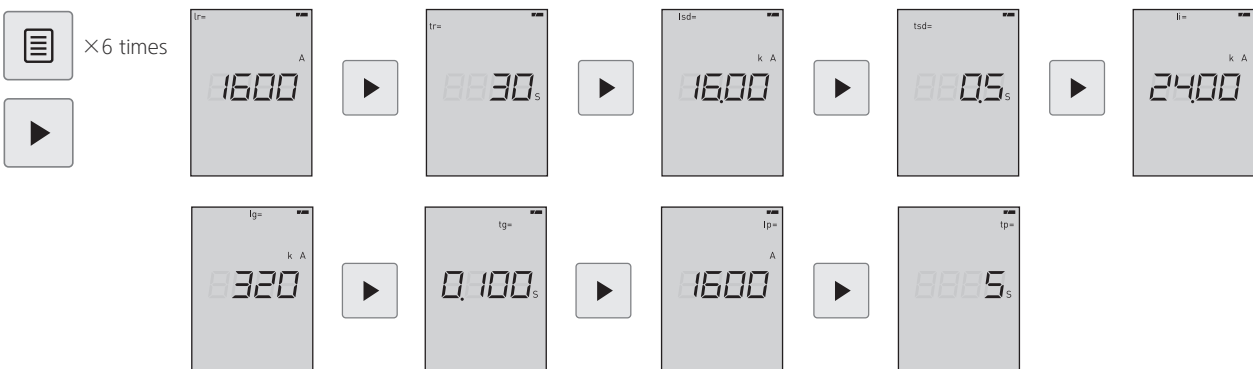

This mode can check pickup setting value and time setting value per each item.

You can check each menu by movement button in regular sequence of LTD > STD > INST > PTA > GFT > ELT.

Each menu shows its pickup setting value, delayed time value moving by button.

06 Protection Relay - GPR

- List button () - In case of pushing 7 times: Frequency confirmation

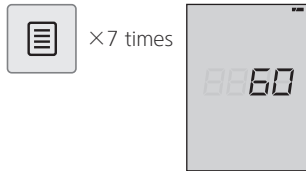

You can set the frequency value. Frequency is available for 50/60 Hz.

※ When changing frequency, you have to reboot it with power source once disconnected and reconnect it.

- List button () + Movement button () - In case of pushing both for 3 seconds : Neutral protection setting

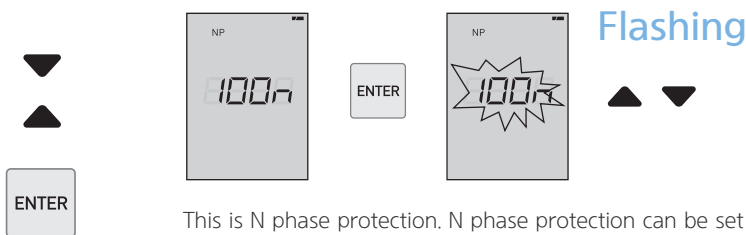

This is N phase protection. N phase protection can be set as 100 %, 50 %, non of In value.

Once you push enter button, figures flash, it turns into setting mode. Use hi/low button during this setting mode and then press enter button when you finished setting.

- Movement button () - In case of pushing it 1 time: Baud rate setting

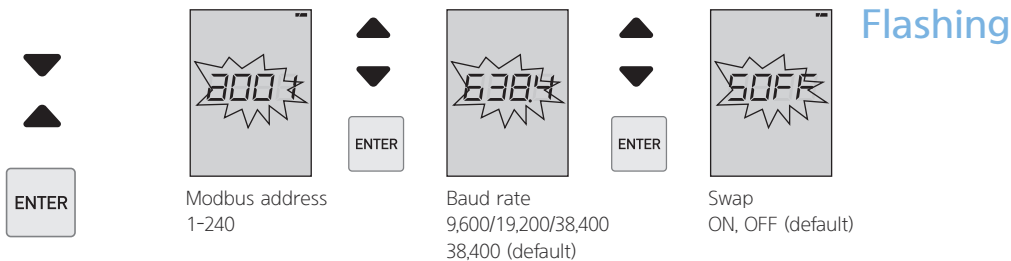

Modbus address
1-240

Baud rate
9,600/19,200/38,400
38,400 (default)

Swap
ON, OFF (default)

This is communicational parameters setting mode. Pressing enter button at each screen make figures flashing, turning into setting mode. Using hi/low button to adjust value, and press the enter button when you finished setting.

- Communication protocol : Modbus-RTU • Data bit: 8 bit • Parity: non • Stop bit: 1

Modbus address can be set between 1-240, and basically set as 1.

Baud rate can be set as 9,600/19,200/38,400 and basically set as 38,400.

Swap is transmitting function which able to transmit data byte more than word.

Ex) 0×1234 } 0×3412

- Movement button () - In case of pushing it twice: Setting in (SA type only)

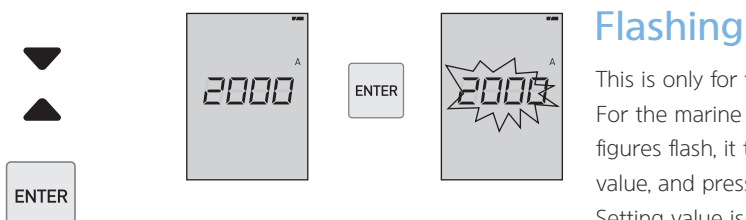

This is only for the SA type of OCR.

For the marine type you can set the in value. Pressing the enter button, figures flash, it turns into setting mode. Using hi/low button to adjust value, and press the enter button when you finished setting.

Setting value is available for 50-100 % of Ict, with 1 A unit.

- Movement button () - In case of pushing it twice : Demand time setting (P type only)

Demand value of active power

Demand value of phase

ENTER

Flashing

Demanding value is average value during given time.
 Set the time for demanding value calculation of power and current.
 Pressing enter button, figures are flashing, it turns into setting mode.
 Using hi/low button to adjust value, and press the enter button when you finished setting.
 Time setting is available from 5 to 60 minutes, by 1minute unit.
 Default setting is 15 minutes.

- Movement button () - In case of pushing it 3 times: Network setting.

ENTER

ENTER

This is setting mode of network type.
 It is restricted by type of OCR 3-pole/4-pole.

※ Network setting criteria is determined by type of ACB.

ACB CT	OCR type	Network
3	3-poles	3P3W, 3P4W
4	4-poles	4P4W

※ In case of 3P ACB but with 4 wire connection, you have to set network as 3P4W.

When you press enter button, figures are flashing, it turns into setting mode. Using hi/low button to adjust value, and press the enter button when you finished setting.

- Movement button () - In case of pushing it 4 times: Power factor sign convention setting (P type only)

ENTER

ENTER

Flow of active and reactive power

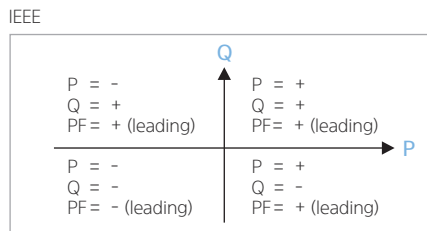
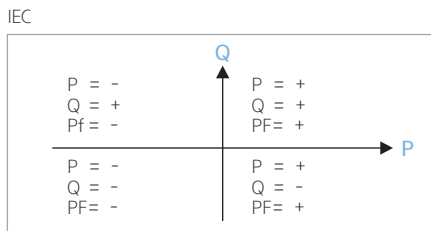
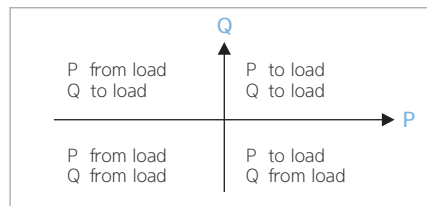

This is setting mode regarding power factor sign convention according to IEC and IEEE.

Signs are determined from the active power and reactive power flow.

Pressing enter button, figures are flashing, it turns into setting mode. Using hi/low button to adjust value, and press the enter button when you finished setting. Basic setting is IEC convention.

06 Protection Relay - GPR

- Movement button (▶) - In case of pushing it 5, 6, 7 times: Time setting

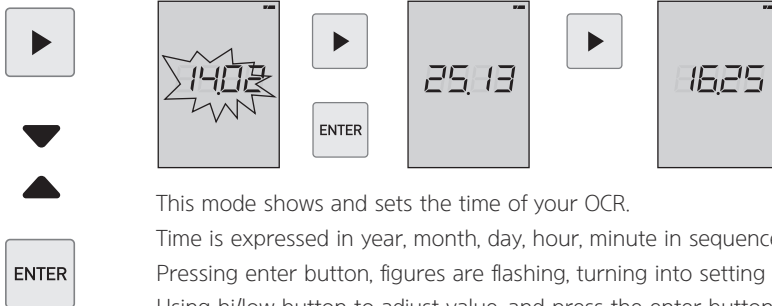

This mode shows and sets the time of your OCR.

Time is expressed in year, month, day, hour, minute in sequence each in two digit number.

Pressing enter button, figures are flashing, turning into setting mode.

Using hi/low button to adjust value, and press the enter button when you finished setting.

※ OCR time runs by replaceable battery. You have to replace it when 'LOW'.

- Movement button (▶) - In case of pushing it 8 times: OCR version confirmation

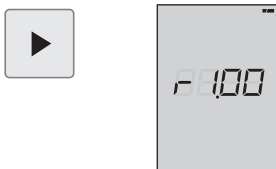

This mode shows version of your OCR.

- Movement button (▶) - In case of pushing it 9 times: OCR model number confirmation



This mode shows model number of your OCR.

4) Flow-current test of the main circuit

(1) Temperature test

If rated current flowed current to a 3-poles series connection and 1-phase source, the breaker functioning GFT will work and trip the ACB.

This is 2-poles among 3-poles in the same direction, pick-up circuit inside GPR protection relay flows unbalanced current as a vector. Therefore, in the temperature test in 1-phase source system, before test, separate NHT connection cable to prevent from GFT trip.

(2) Overcurrent trip test

Turn the GFT function knob to NON and execute LTD test.

To test relay setting with single phase source, ACB with GFT function will trip by GFT because of load unbalance.

- GFT function in a circuit breaker is in the single-phase type.

In the breaker functioning GFT, in case that the current in the 1-phase is approved by approving load unbalance GTF operates.

07 Insulation Resistance Test and Dielectric Withstand Test

The insulation resistance test and dielectric withstand test for main circuit and control circuit are performed as follows:

7.1 Main Circuit

- Dielectric withstand voltage performance is AC 3,500 V for one minute.
- Use a DC 500 V insulation resistance tester (megger) (over 300 ohm).

7.2 Control Circuit (to earth)

- Dielectric withstand voltage performance is AC 1,500 V for one minute.

For DC 24 V rating of motor charging and closing operation circuits, its characteristic is AC 500 V for one minute (control circuit terminals ①, ②, ③).

For DC rating of the following control circuits, withstand voltage test is impossible.

- Control circuit terminals ⑨ and ⑩ of undervoltage trip device (UVT).
 - The terminals ⑱ and ⑳ of GPR protection relay.
- Use DC 500 V insulation resistance tester (megger) for insulation resistance test.

CAUTION

The circuit connected with OCR do not test insulation resistance test and dielectric test.
There are possibilities of malfunction and breakdown by damaging for internal protection device.
(Control Jack : No.19~20, VR, VS, VT, VN)

08 Troubleshooting Points

No.	Trouble	Phenomenon		Expected Causes	Corrective Actions
		Machine	Electrical		
1	Close fault	×	×	1. Mechanism badness	1. Contact HE
				2. Whether it is charging by handle mechanism	2. Contact HE
				3. Is close rod returned ?	3. Close rod returning check
				4. Whether inertia latch is jamming or not ?	4. Inertia latch movement check.
				5. Is ACB placed in proper position (ISO-TEST-CON) ?	5. Move to proper position
				6. Is GPR manual reset button pull out ?	6. Push back GPR manual reset button
				7. Is UVT coil applied proper voltage ?	7. UVT source check
				8. Is position lock button handle cover pushed in ?	8. Handle cover comeback . Push draw in/out handle and adjust position confirm button returning
				9. The breaker caught interlock ?	9. Interlock dissolution
				10. Is trip latch turned down ?	10. Trip latch returning
		×	O	1. Is close rod returned ?	1. Close rod returning
				2. Is trip latch turned down ?	2. Trip latch returning
		O	×	1. Is proper voltage applied to CC coil ?	1. CC coil voltage check
				2. Is CC coil operates normally ?	2. Coil replacement
				3. Is CC coil stroke in proper position ?	3. Stroke check
4. Is UVT coil applied proper voltage ?	4. UVT source check				
5. Is over current relay reset ?	5. Reset OCR				
2	Open fault	×	×	1. Whether any interlock system exist ?	1. Contact HE
				2. Whether trip latch exists bur ?	2. Contact HE
		O	×	1. Whether proper voltage applied to TC coil ?	1. TC coil voltage check
	2. Whether TC coil exists mechanical interference			2. After voltage is applied, check core movement	
	3. Whether proper voltage applied to UVT coil ?			3. UVT coil voltage check	
	3	Charging fault	×	×	1. Whether handle mechanism cam operates normally ?
O					×
			2. Whether motor control unit is damaged	2. Motor output voltage check	
			3. Whether motor ratchet (M/B) is proper	3. Part check	

09 Appendix

9.2 Ground Protection Method

1) Grounded neutral Y-Y transformer

(1) In case of 3-poles ACB with 3-phase 4-lines

The neutral pole CT connects neutral pole terminals.

When remaining current of CT exceeds setting value, ACB is tripped to GFT.

As the ratio of the neutral poles lowers, apply HE NCT (only for GPR optional).

I_g	$I_{CT} \times (0.1-0.2-0.3-0.4-0.5-0.6-0.7-0.8-1.0- \text{Non})$ 10 steps
Pickup Current Adjustment	$I_{CT} \times$ from 0.1 to 1.0 type-step temporarily adjustment
Tolerance	$\pm 20 \%$
Trip Time (ms)	50-100-200-300-400-500 msec

(2) In case of using 4-poles ACB with 3-phase 4-lines

The neutral pole is equipped with CT in 4-poles ACB, CT sense remaining current not ground but vector sum of CT of 4GE by ground.

In case of $I_a + I_b + I_c + I_n = 0$, Non Trip

In case of $I_a + I_b + I_c + I_n \neq 0$, Trip

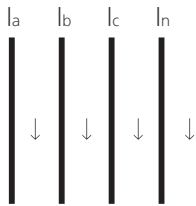

(3) In case of using 3-poles ACB with 3-phase 3-lines, the operating principles is the same

In case of $I_a + I_b + I_c = 0$, Non Trip

In case of $I_a + I_b + I_c \neq 0$, Trip

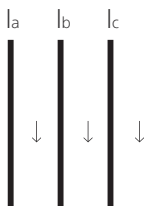

2) Insulated system Y- Δ transformer

At isolated-neutral system, the grounded current is very small.

HE GPR protection relay can not detect small grounded current at this system can not applied.

If you need GFT function at this system, please select GPR with ELT (option) and ZCT.

9.3 Closing and Trip Operation Cycle

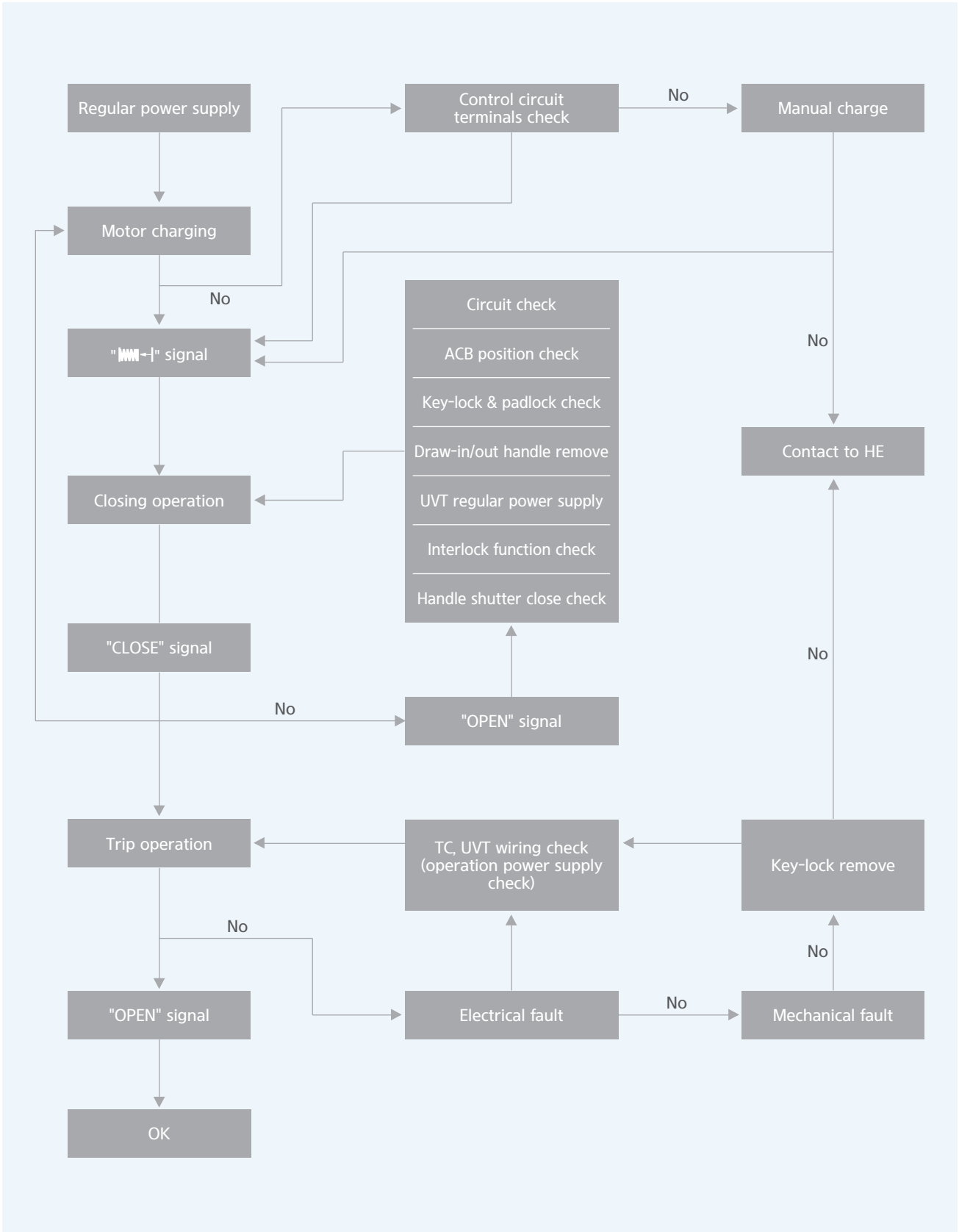

09 Appendix

9.4 Wiring Circuit for GPR Protection Relay

GPR-LN

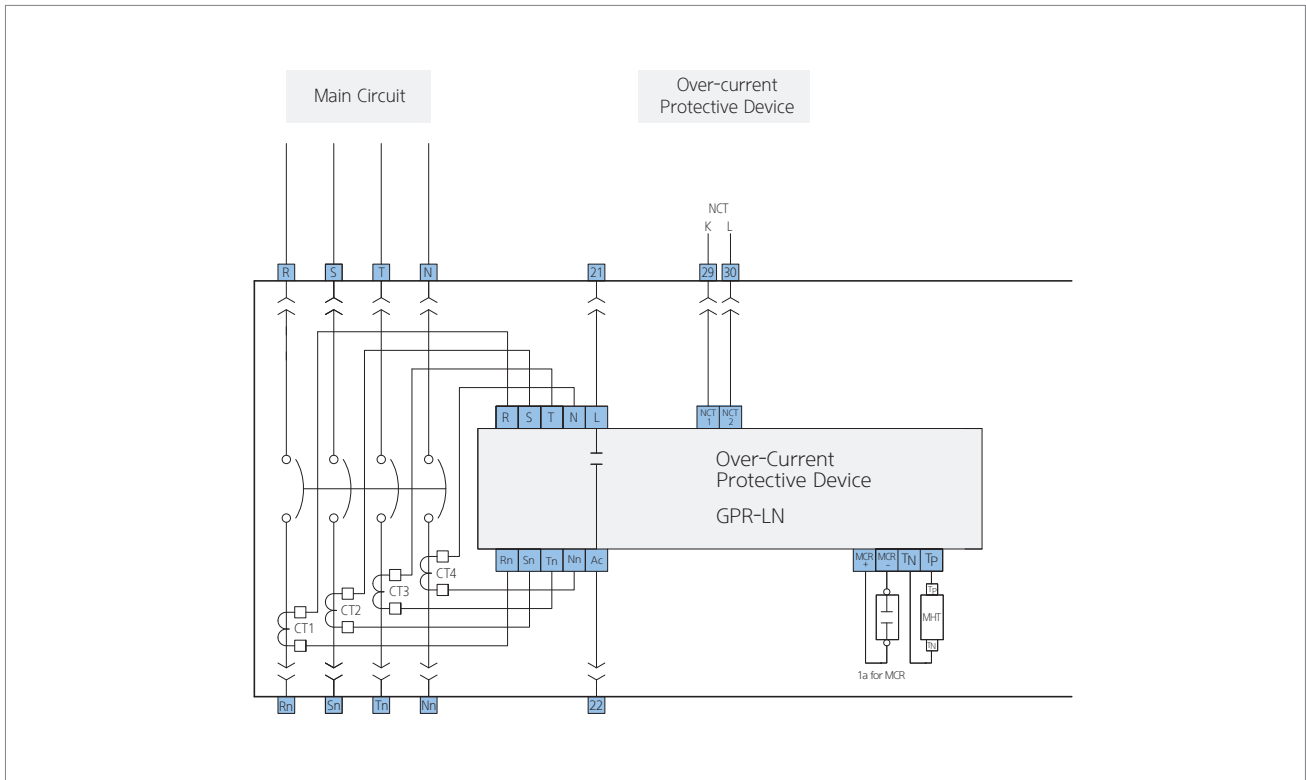

GPR-LA

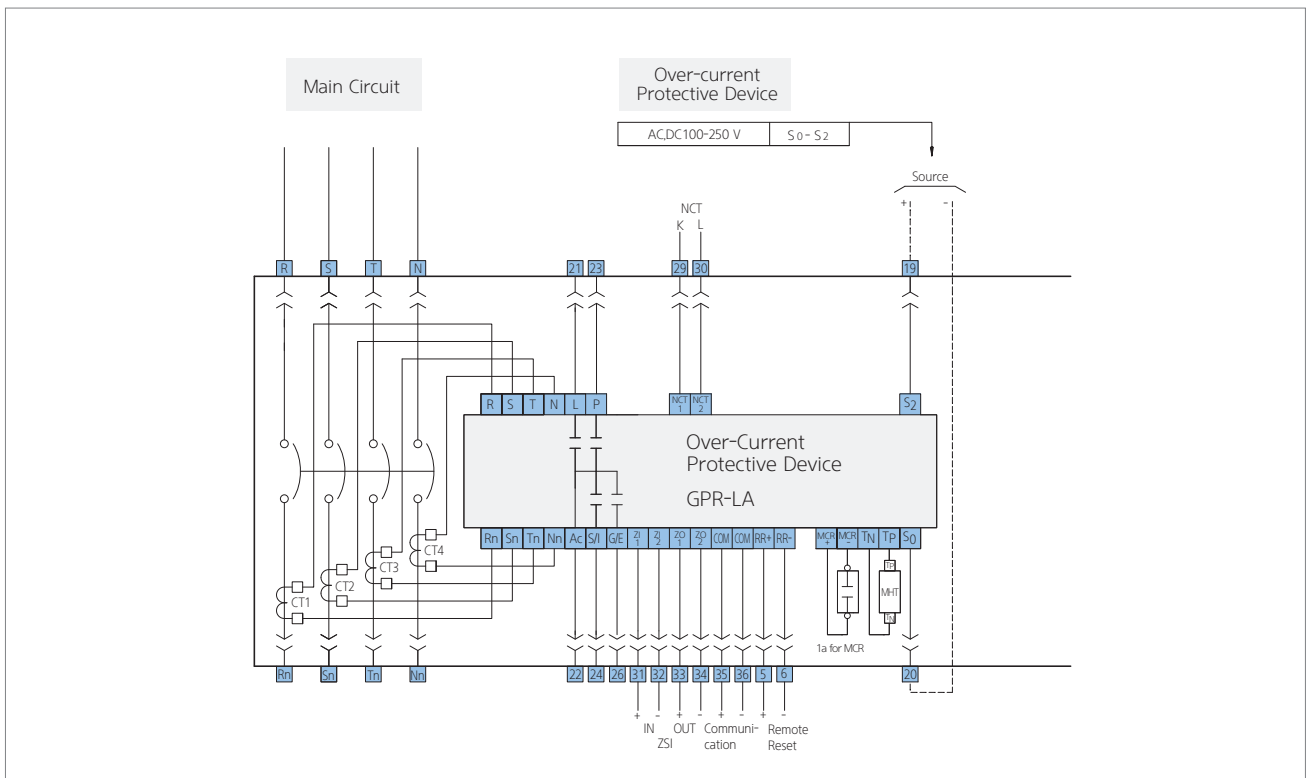

GPR-LAG/LAZ

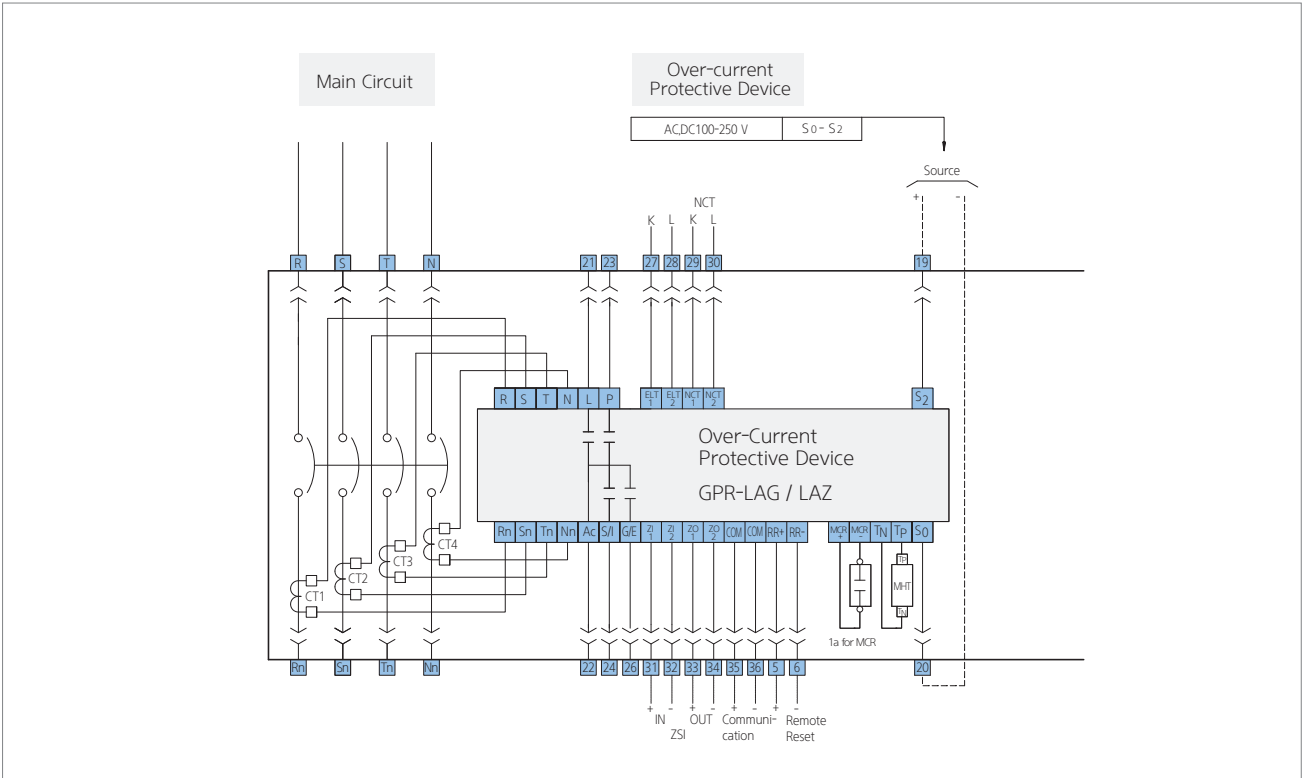

GPR-LP/LH

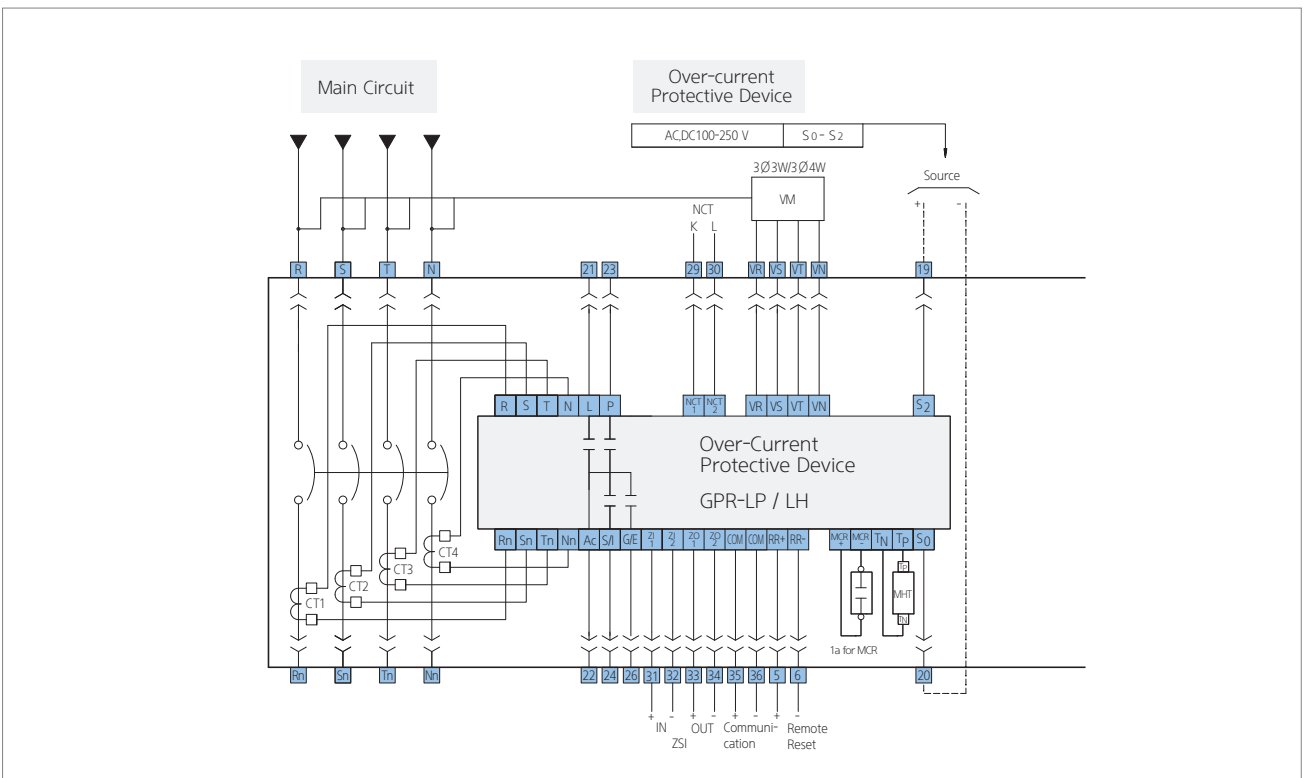

09 Appendix

GPR-SN

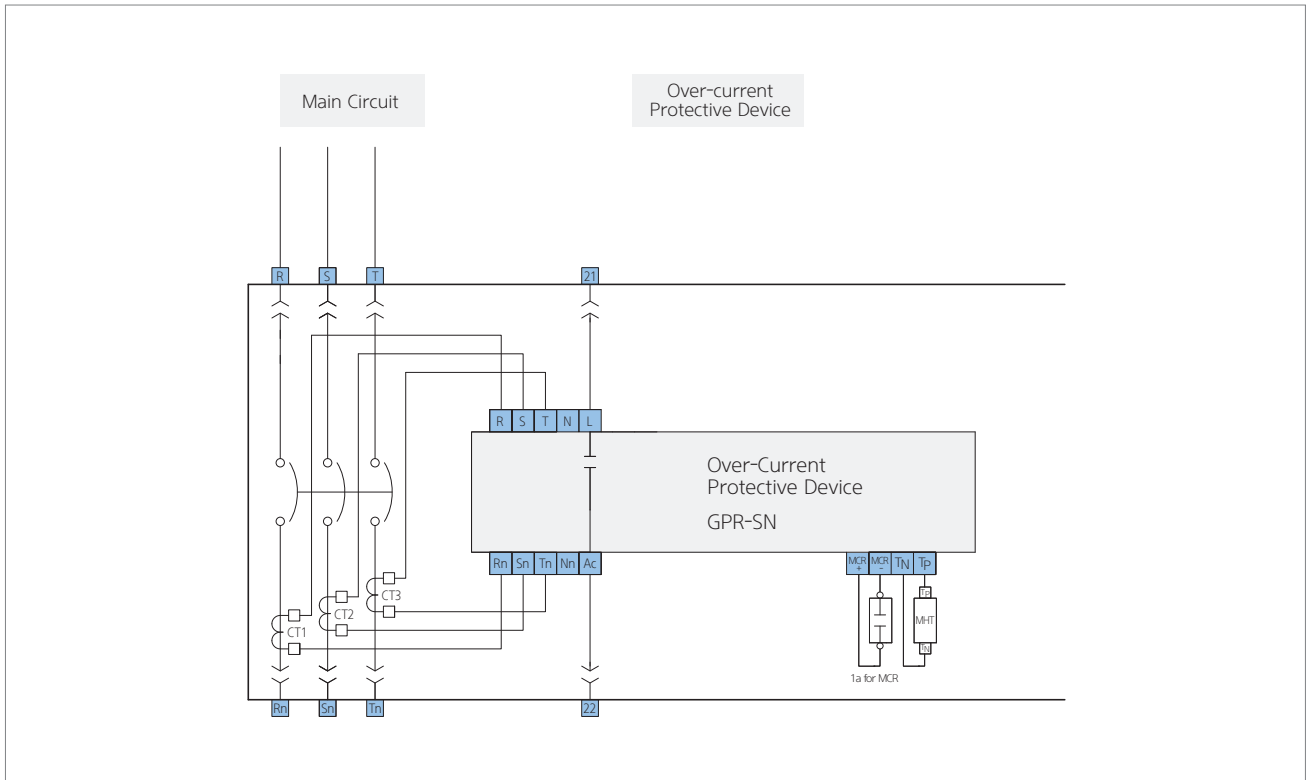

GPR-SA

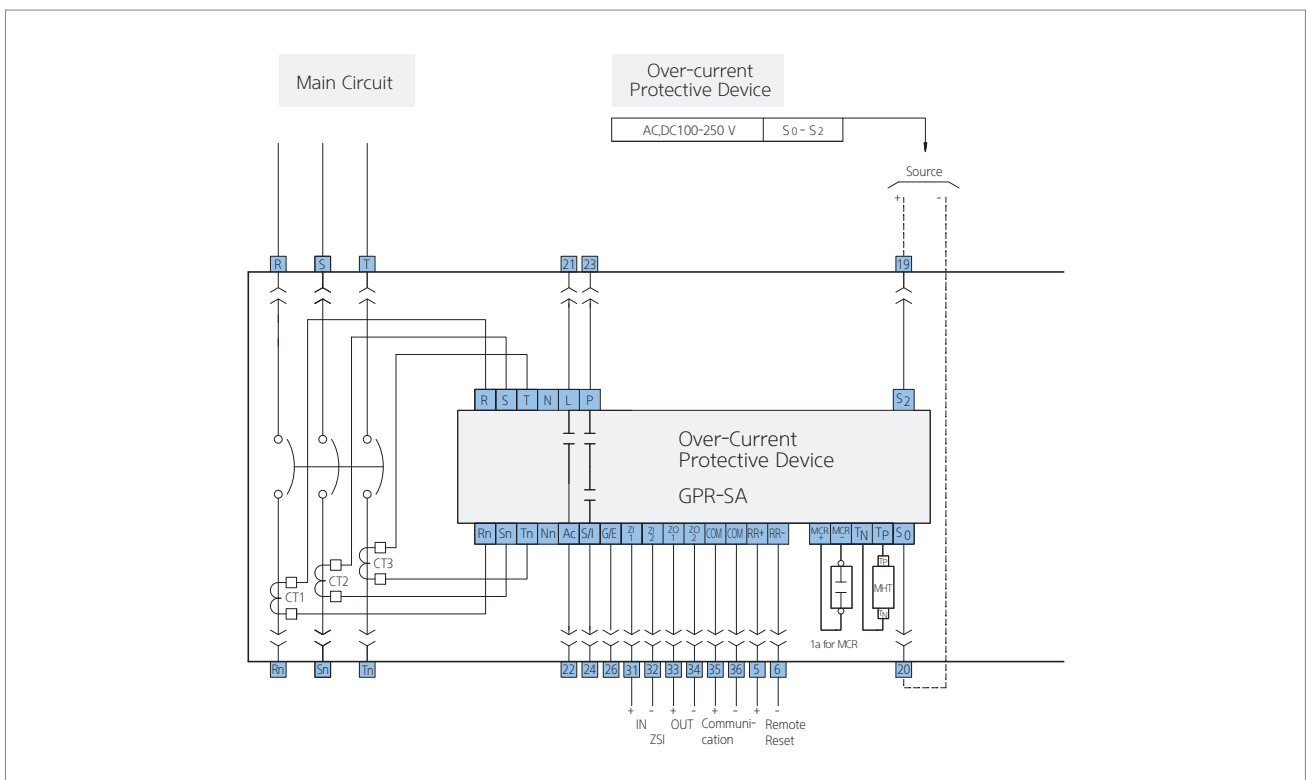

GPR-SP

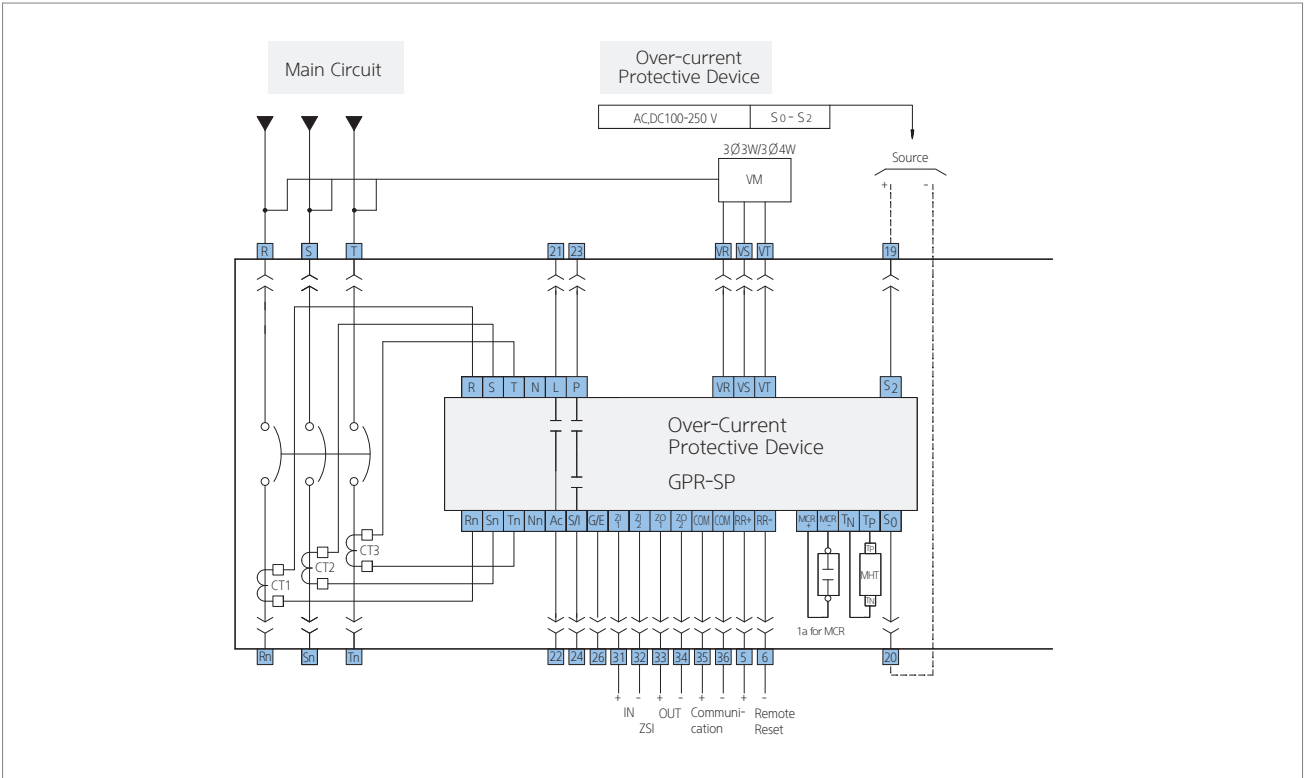

09 Appendix

9.5 Wiring Circuit for ACB

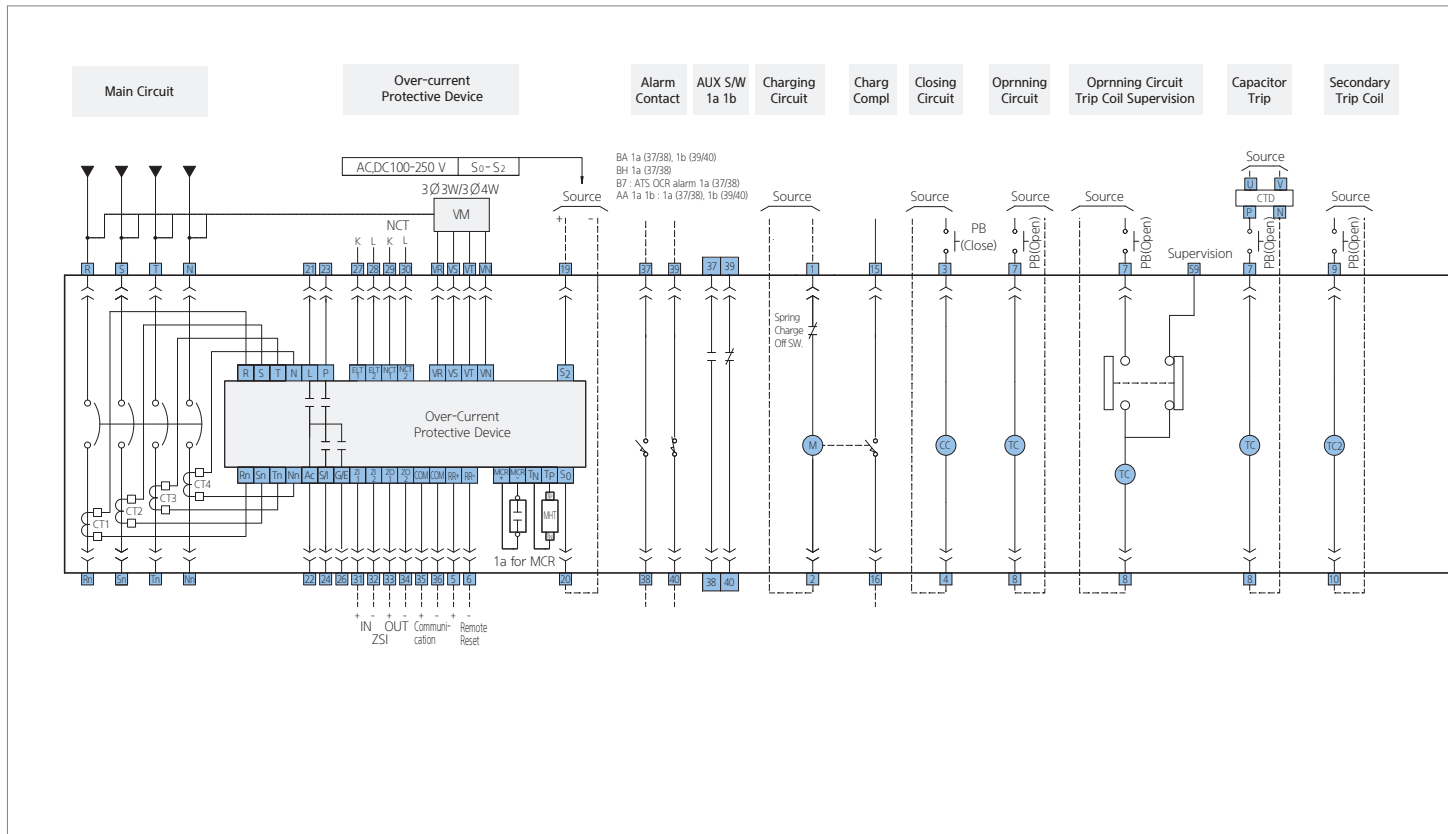

Symbol description

CT	Current transformer
L	LTD terminal
PT	PTA (pre-trip alarm) terminal
G	Ground fault terminal
S/I	STD/INST terminal
Ac	Common terminal
NCT	Neutral current transformer
ZI	Zone selective input
ZO	Zone selective output
MCR +/-	MCR input terminal
Tp / Tn	MHT input source
M	Charging motor
CC	Close coil (close)
TC	Trip coil (open)
UVT	Under voltage trip coil
CT	Magnetic hold trigger
S0 / S2	GPR protection relay source power

Terminal description

1	2	Charging motor (M) source power
3	4	Closing coil (CC) source power
7	8	Open coil (TC) source power
9	10	UVT coil terminal
15	16	Charge complete contact
19	20	OCR source power
22	21	LTD contact
22	23	PTA/TEMP contact
22	24	STD/INST contact
22	26	GFT/ELT contact
29	30	NCT input terminal
31 - 34		ZSI
41 - 60		AUX. contact
61 - 93		Position switch

— Manufacturer's wiring
 ---- User's wiring
 << Disconnecting device (draw out type)

- RR / Remote Reset
- VM / Voltage Module
- VR~VN / Voltage phase input
- R~N / Current input
- Rn~Nn / Current input

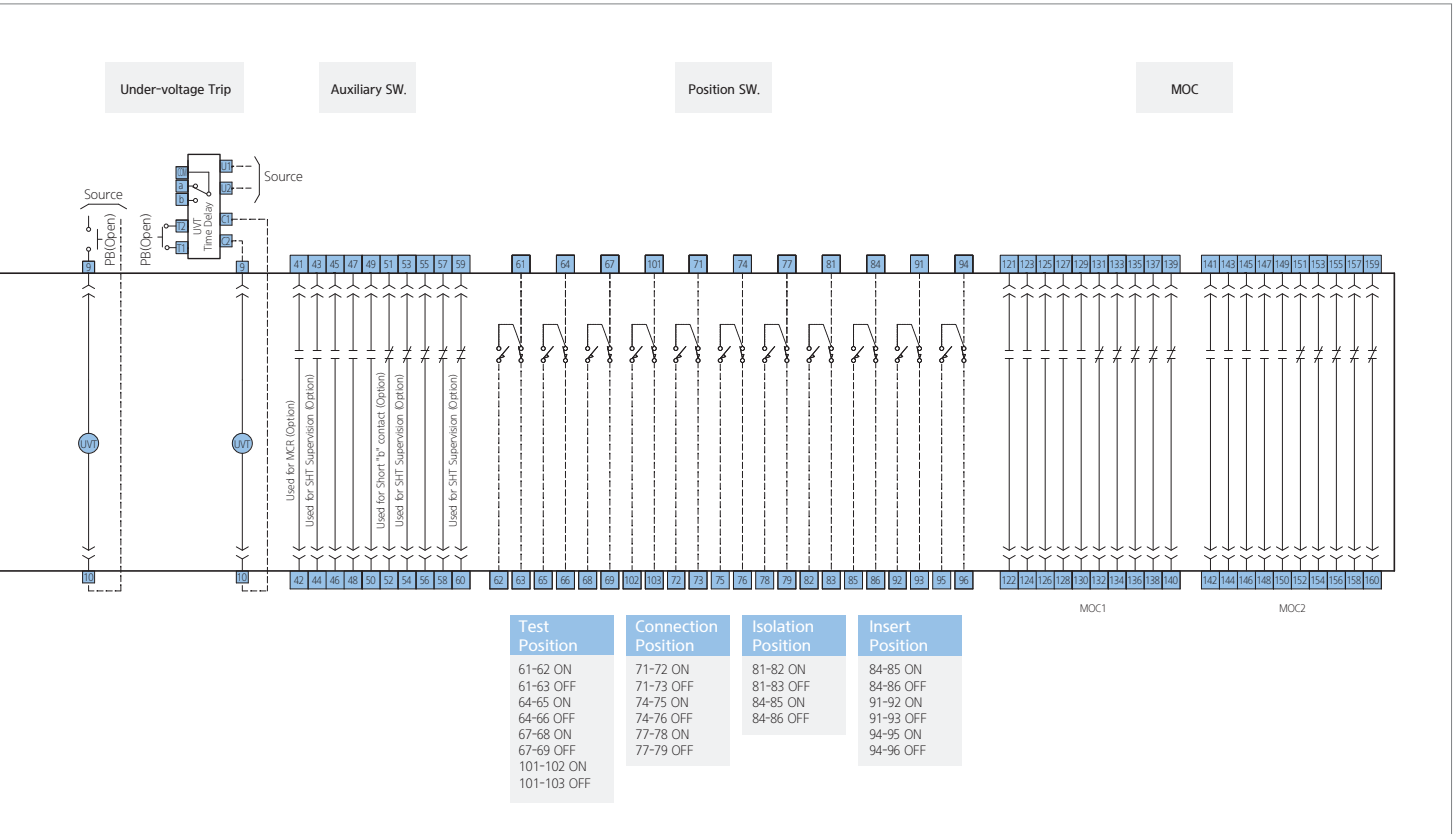

Control jack lay-out

POW	OCR										Operating					Auxiliary switch											
	OCR Contact					ELT	N-CT	ZSI	COM	Temp	V Input	M	CC	TC	UVT	CHA	1a	2a	3a	4a	5a	1b	2b	3b	4b	5b	
	COM	L	S/I	P/T	G/E																						
19	21	23	27	29	31	33	35	37	39	VR	VT	1	3	7	9	15	41	43	45	47	49	51	53	55	57	59	
20	22	24	26	28	30	32	34	36	38	40	VS	VN	2	4	8	10	16	42	44	46	48	50	52	54	56	58	60

OCR Protection relay Operating circuit Auxiliary switch

OCR												
POW	OCR Contact					ELT	N-CT	ZSI	COM	Temp	V Input	
	COM	L	S/I	P/T	G/E							
19	21	23	27	29	31	33	35	37	39	VR	VT	
20	22	24	26	28	30	32	34	36	38	40	VS	VN

- GPR Protection relay -

Operating				
M	CC	TC	UVT	CHA
1	3	7	9	15
2	4	8	10	16

- Operating circuit -

Auxiliary switch									
1a	2a	3a	4a	5a	1b	2b	3b	4b	5b
41	43	45	47	49	51	53	55	57	59
42	44	46	48	50	52	54	56	58	60

- Auxiliary switch -



KOREA

Headquarter (Financial)	Hyundai Bldg, 75, Yulgok-ro, Jongno-gu, Seoul, Korea Tel: +82-2-746-7646 / Fax: +82-2-746-7441
Sales & Marketing (Seongnam)	5th Floor 55, Bundang-ro, Bundang-gu, Seongnam-si, Gyeonggi-do, Korea Tel: +82-31-8006-6780 / Fax: +82-31-8006-6898
Main Factory (Ulsan)	700, Bangeojisunhwan-doro, Dong-gu, Ulsan, Korea Tel: +82-52-202-8114 / Fax: +82-52-202-8010
Seonam Factory (Ulsan)	223, Sapyong-ro, Nam-gu, Ulsan, Korea Tel: +82-52-202-8114
R&D Center (Yongin)	17-10, 240-gil, Mabuk-ro, Giheung-gu, Yongin-si, Korea Tel: +82-31-289-5114 / Fax: +82-31-289-5040

OVERSEAS

Branch Offices

U.S.A (Atlanta)	6100 Atlantic Boulevard, 2nd FL., Norcross, GA30071, U.S.A Tel: +1-678-823-7839 / Fax: +1-678-823-7553
Japan (Osaka)	5th Floor Nagahori Plaza Bldg. 2-4-8 Minami Senba, Chuo-ku, Osaka 542-0081, Japan Tel: +81-6-6261-5766~7 / Fax: +81-6-6261-5818
Saudi Arabia (Riyadh)	Office number 404, 4th floor, Akaria-3 building, Olaya street, P.O Box 8072, Riyadh, 11482, Kindom of Saudi Arabia Tel: +966-11-464-4696, 9366 / Fax: +966-11-462-2352
Russia (Moscow)	World Trade Center, Ent.3, #703, Krasnopresnenskaya Nab.12, Moscow, 123610, Russia Tel: +7-495-258-1381
U.A.E (Dubai)	Unit 205, Emaar Square Building No.4 Sheikh Zayed Road, Dubai 252458, U.A.E Tel: +971-4-425-7995 / Fax: +971-4-425-7996
Germany (Frankfurt)	Mendelssohn strabe 55-59 Frankfurt 60325, Germany Tel: +49-69-4699-4988
Thailand (Bangkok)	19th Floor, Unit 1908, Sathorn Square Office Tower, 98 North Sathorn Road, Silom, Bangrak, Bangkok 10500, Thailand Tel: +66-02-115-7920 / Fax: +66-2-115-7898

Subsidiaries

U.S.A (Alabama)	Inc., 215 Folmar Parkway, Montgomery, AL 36105, U.S.A. Tel: +1-334-481-2000 / Fax: +1-334-481-2098
Bulgaria (Sofia)	41, Rojen Blvd., 1271 Sofia, Bulgaria Tel: +359-2-803-3200, 3210, 3220 / Fax: +359-2-803-3203, 3242
China (Yangzhong)	No.9, Xiandai Road, Xinba Scientific and Technologic Zone, Yangzhong, Jiangsu, P.R.C. Zip:212212, China Tel: +86-511-8842-0666, 0500 / Fax: +86-511-8842-0668, 0231
India (Anantapur)	5-289-4, Near Aimuktheeshwara Temple, Penukonda Mandal, Penukonda, Anantapur Dist, Andhrapradesh-515110, India Tel: +91-93982-5137

R&D Centers

Hungary (Budapest)	Hyundai Technologies Center Hungary Ltd., 1146, Budapest, Hermina ut 22, Hungary Tel: +36-1-273-3733 / Fax: +36-1-220-6708
China (Shanghai)	Room 10102, Building 10, No.498, Guoshoujing Road, Pudong, Shanghai, China Tel: +86-21-5013-3393 #108 / Fax: +86-21-5013-3393 #105
Switzerland (Zurich)	Hardturmstrasse 135, CH-8005, Zurich, Switzerland Tel: +41-44-527-0-56