

Components for Medium Voltage cubicles

Panorama for panel builders - 2013

"The widest range of components to meet all your requirements"



Schneider
Electric

An exhaustive range

to meet all Panelbuilders

requirements!

The true Peace of Mind!

Schneider Electric commitments

High Quality components

Based on our expertise in building Medium Voltage cubicles, **all the proposed components are designed to be fully consistent with the others.**

This gives an assurance of complete interoperability, which has been tested in our own Medium Voltage cubicles equipped with these components.

Moreover, our industrialized processes and quality controls guarantee the highest level of component quality to meet your most demanding expectations.

Easy to integrate

Benefit from our tools and training package to increase your product knowledge and ensure easy integration, **allowing you to be more efficient in your business.**

All necessary information on mounting and assembly is supplied with each component.

Compatible with Smart Grid application

Given the demand for an increasing number of energy production sources and the increasingly significant obligations of network adaptability, **operators have to know, understand and act correctly:**

- Know the switchboards' status at all times.
- Act with full knowledge of the facts.

Medium-voltage switchboards thus demand more and more remote measurement and control capabilities.

You will therefore find a **whole range of latest-generation monitoring and control devices acting in full complementarity** with the Medium Voltage switching devices.

Easy to source, continuous and worldwide availability

Thanks to Schneider Electric's direct presence in more than 100 countries, you can be sure of finding the range of products and devices meeting your needs and complying perfectly with local standards.



Fully type-tested products

Compliance with the latest international and local standards

Tools for your business performance:

- Drawings
- Configurators
- Technical manuals (user guides, installation manuals...)
- Products catalogues
- Maintenance guides & End of life manuals



Benefit from Schneider Electric's image and know-how

Schneider Electric's policy has always been to provide its customers with very close support in their daily activities to enable them to achieve operational excellence.

In this overview, Schneider Electric presents to you all the components that you may need to build your Medium Voltage cubicle, from Medium Voltage to Low Voltage components, under Schneider Electric brand.

The experience of a world leader in Medium Voltage

Schneider Electric has been manufacturing MV cubicles for more than 50 years and its installed base amounts to millions products and devices.

The Schneider Electric brand is known worldwide and recognized by the most demanding customers.

A long history of innovation for a global offer

Based on this experience as world leader, Schneider Electric has developed a large and comprehensive range of innovative Medium Voltage devices employing vacuum, air and SF6 technology.

With the first multi-functional digital protection relay created in 1982, you take benefit of a global leader experience and know-how in electric distribution, automation and Power & control.

All the devices included in this overview have been designed and manufactured to incorporate the benefits of this extensive experience.

Quality certification:

ISO 9001 and ISO 14001

In each of its units, Schneider Electric has an operating organization whose main role is to verify quality and ensure compliance with standards.

This procedure is:

- uniform for all departments;
- recognized by numerous customers and official organizations.

The quality system for design and manufacturing is certified in compliance with the requirements of the ISO 9001 Quality Assurance model.

Our common values :

- Quality
- Safety
- Professionalism

5% of sales
devoted to R & D

Local support
all over the world.

There are always
Schneider Electric people
close to you:

100000 people
in more than

100 countries!

Schneider Electric a brand you can trust

The widest range
of components
to meet all
your requirements!

Contents

Medium Voltage switching devices **A-1**

Protection, Metering & Remote control **B-1**

Power Factor Correction **C-1**

Accessories **D-1**

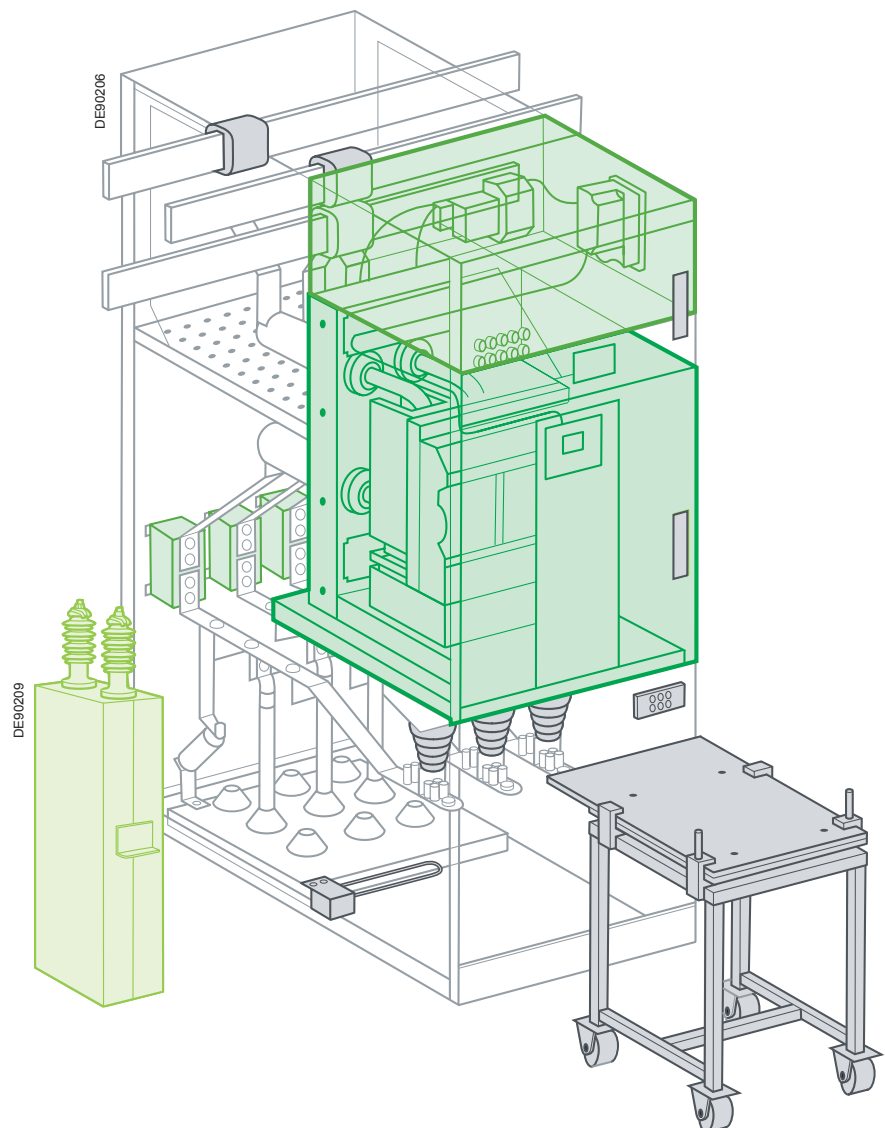

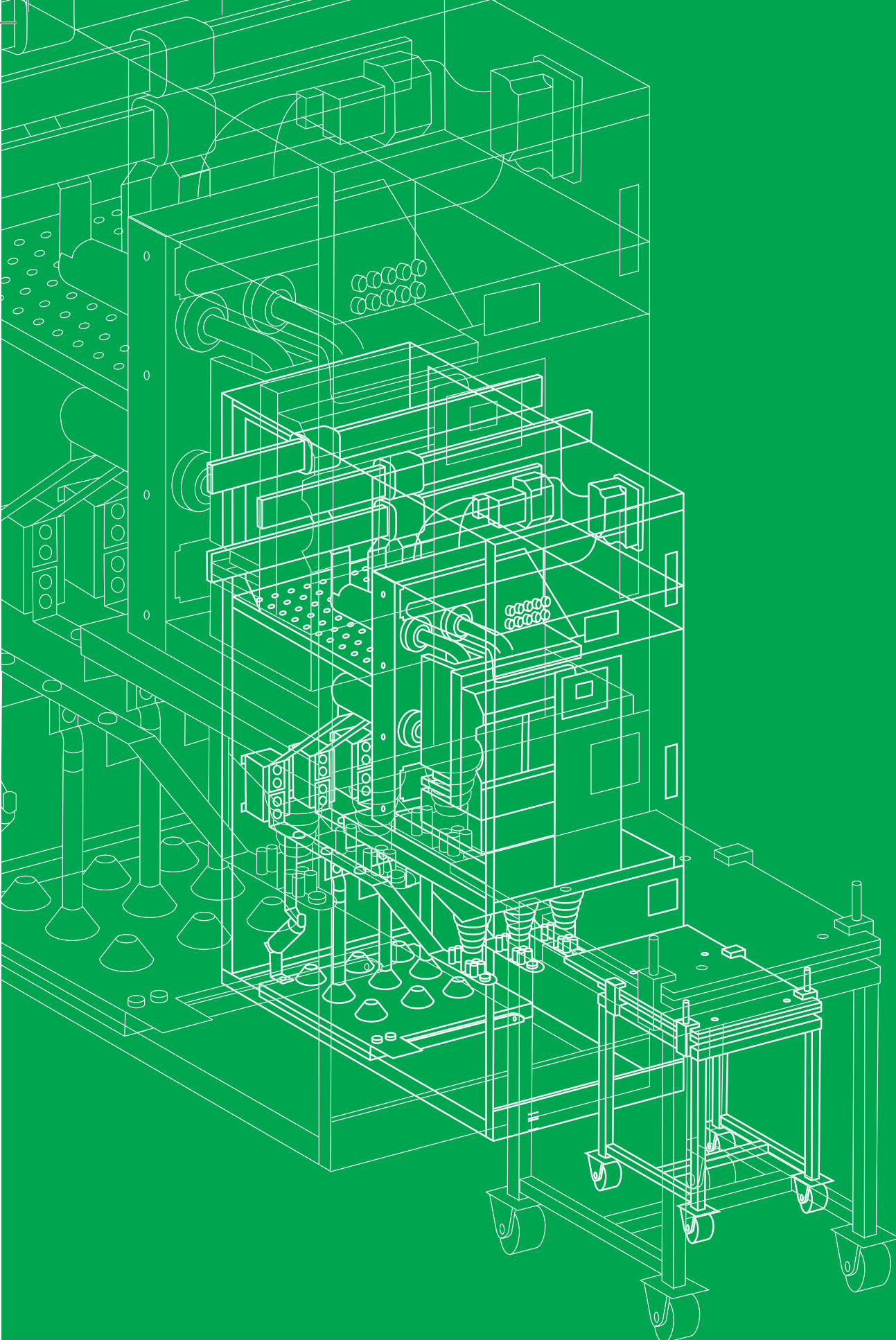

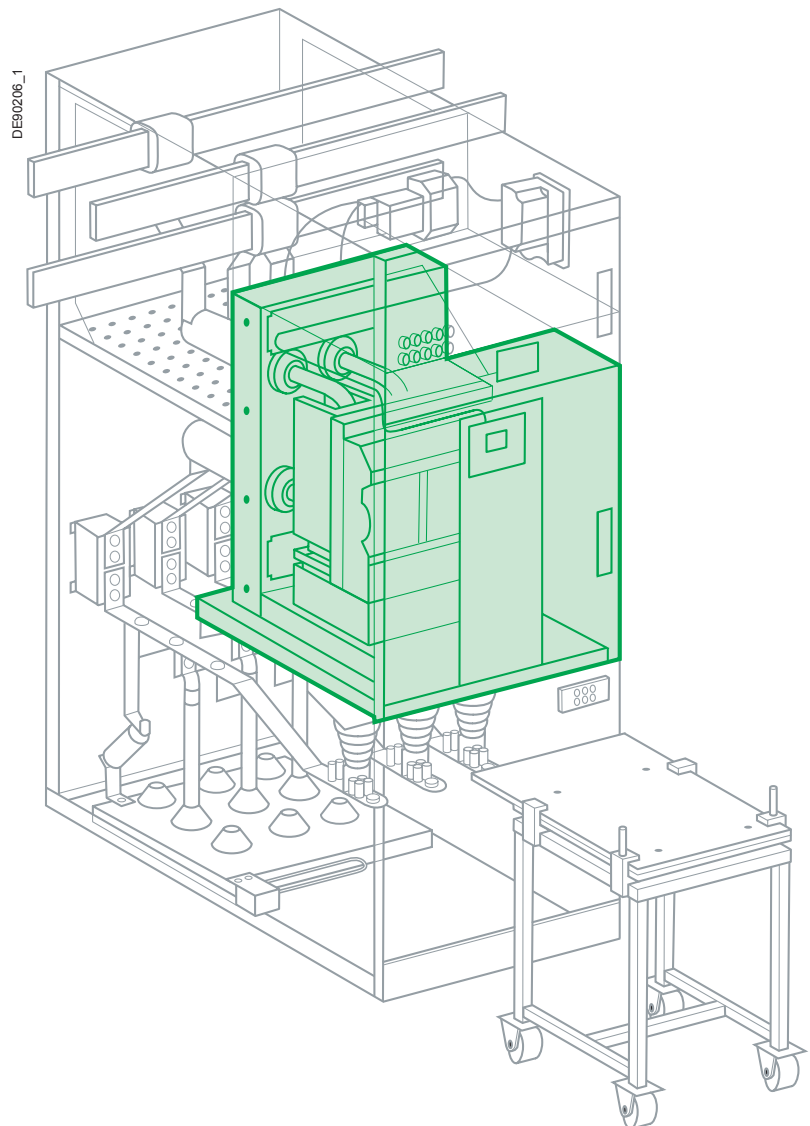

Circuit-Breakers - Contactors - Switches & Disconnectors - Fuses - Protection relays - Arc fault detectors - MV instrument transformers - Energy management & control - LV protection - Direct Current Power supply - LV relays - LV Control & Signalling - Substation remote control and monitoring & Fault indicators - Substation power supply - Capacitors & Power Factor controller - Relay & Switching devices - Accessories

Circuit-Breakers	A-2
Contactors	A-4
Switches & Disconnectors	A-6
Fuses	A-7

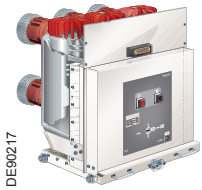
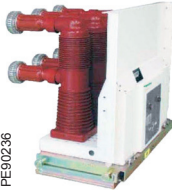

Vacuum Circuit-Breakers						
HVX - Embedded pole				Evolis		
						
Functions						
Protection and operation of network						
Rated voltage						
12 kV	17.5 kV	24 kV	36 kV	40.5 kV	12 kV	17.5 kV
Max. rated short-circuit current						
50 kA	50 kA	31.5 kA	31.5 kA	31.5 kA	31.5 kA	31.5 kA
Max. rated current						
3150 A	3150 A	3150 A	2500 A	2500 A	2500 A	2500 A
Versions						
<ul style="list-style-type: none"> • Fixed • Withdrawable 		<ul style="list-style-type: none"> • Fixed • Withdrawable 		<ul style="list-style-type: none"> • Fixed • Withdrawable 		
Number of poles						
3p		3p		3p		
Mechanical switching cycles (ON/OFF)						
10000		10000		10000		10000
Mounting						
Front		Front		Front		
Mechanism						
Conventional spring		Conventional spring		Conventional spring		
IEC, GB (chinese) standards		IEC, GB (chinese), GOST standards		IEC standards		
Benefits						
Embedded pole for better dielectric & environmental pollution withstand		Embedded pole for better dielectric & environmental pollution withstand		<ul style="list-style-type: none"> • Compact dimensions • Reliable spring mechanism for open pole technology 		



SF6 Circuit Breakers

LF

SF1

SF2



PE57191



PE30232



PE56601

Functions

Protection and operation of network

Rated voltage

	17.5 kV		17.5 kV	24 kV	36 kV	36 kV	40.5 kV
12 kV		12 kV					

Max. rated short-circuit current

50 kA	40 kA	25 kA	25 kA	25 kA	25 kA	40 kA	31.5 kA
-------	-------	-------	-------	-------	-------	-------	---------

Max. rated current

3150 A	3150 A	1250 A	1250 A	1250 A	1250 A	3150 A	2500 A
--------	--------	--------	--------	--------	--------	--------	--------

Versions

- Fixed
- Withdrawable

- Fixed

- Fixed
- Withdrawable

Number of poles

3p	3p	3p
----	----	----

Mechanical switching cycles (ON/OFF)

10000	10000	10000
-------	-------	-------

Mounting

Front	• Front • Side	Front
-------	-------------------	-------

Mechanism

Conventional spring	Conventional spring	Conventional spring
---------------------	---------------------	---------------------



IEC standards	IEC standards	IEC standards
---------------	---------------	---------------

Benefits

- Suited for nuclear powerplant
- Marine solutions certified

- Integrated VIP trip unit (without auxiliary power supply) in SFset up to 24 kV (for side mounted)
- Suited for capacitor bank application

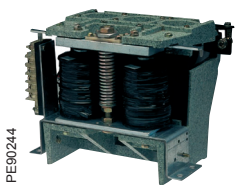
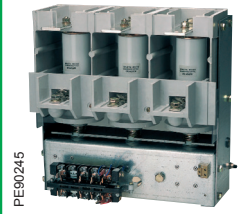
High energy mechanism (230 J) to open at high voltage ratings

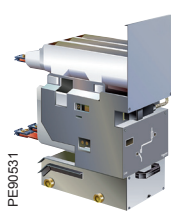
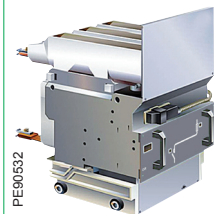
Vacuum contactors					
CPX	CLX	CBX		CVX	
 PE90244	 PE90245	 PE90243	 PE90531	 PE90532	
Functions					
Protection and control of network					
Rated voltage					
3.6kV	7.2kV	7.2kV	12kV	7.2kV	12kV
Max. rated short-circuit current					
4 kA	6 kA	6 kA	4 kA	6 kA*	4 kA*
Max. rated current					
400A (AC4)	400A (AC4)	400A (AC4)	315A (AC4)	400A (AC4)	315A (AC4)
Versions					
• Fixed	• Fixed	• Fixed		• Withdrawable CBX version equipped with DIN or BS fuses • Optional on board auxiliary voltage transformer	• Withdrawable CBX version equipped with DIN or BS fuses
Number of poles					
3p	3p	1p - 3p		3p	3p
Mechanical switching cycles (ON/OFF)					
250 000 (mechanical latch) and 1 000 000 (magnetically held)	250 000 (mechanical latch) and 1 000 000 (magnetically held)	250 000 (mechanical latch) and 3 000 000 (magnetically held)		250 000 (mechanical latch) and 1 000 000 (magnetically held)	250 000 (mechanical latch) and 1 000 000 (magnetically held)
Mechanism					
Magnetic or mechanical latch	Magnetic or mechanical latch	Magnetic or mechanical latch		Magnetic or mechanical latch	Magnetic or mechanical latch
IEC standards					
	IEC standards	IEC, GB (chinese) standards		IEC, GB standards	IEC, GB standards

* 50 kA in conjunction with fuses



Benefits

Special version available for capacitor banks	Front access to terminals	Special version available for capacitor banks	• High short circuit breaking capacity in combination with fuses • LV supply thanks to optional on board VT	High short circuit breaking capacity in combination with fuses
---	---------------------------	---	--	--

SF6 contactor

Rollarc

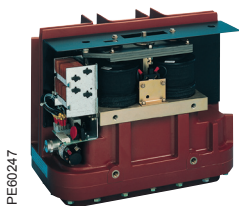

Functions

Protection and control of network

Rated voltage

7.2kV	12kV
-------	------

Max. rated short-circuit current

10 kA	8 kA
-------	------

Max. rated current

400A (AC4)	400A (AC4)
------------	------------

Versions

- Fixed
- Withdrawable

Number of poles

3p

Mechanical switching cycles (ON/OFF)

100 000 (mechanical latch) and 300 000 (magnetically held)

Mechanism

Magnetic or mechanical latch

IEC standards

Reference product in SF6 contactor market, Nuclear powerplant application, Capacitor bank application

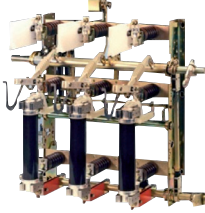
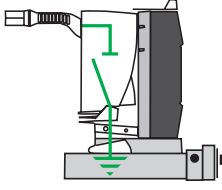
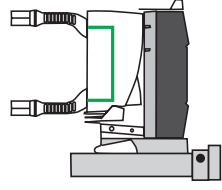
SF6 Switch & Disconnecter		Air Switch & Disconnecter		Withdrawable earthing and disconnector trucks			
LBSkit		L-TRI5		Earthing truck	Disconnector truck		
 <p>PE90386</p>		 <p>PE90384</p>		 <p>DE56784</p>	 <p>DE56785</p>		
Functions							
Indoor load break switch, disconnector and accessories		Indoor load break switch, disconnector		The earthing truck is a safety feature which allows the cubicle busbar to be earthed. It is installed instead of the circuit breaker and has the same interlock possibilities	The disconnector truck enables the upper and lower part of the cubicle to be short-circuited. It is installed instead of the circuit breaker and has the same interlock possibilities		
Rated voltage							
24 kV	36 kV	36 kV			Refer to respective Circuit Breaker range and ratings	Refer to respective Circuit Breaker range and ratings	
Max. rated short-circuit current							
25 kA	25 kA	20 kA	20 kA	20 kA			
Max. rated current							
630 A	1250 A	630 A	1600 A	2500 A			
IEC standards		IEC standards					



Benefits			
<ul style="list-style-type: none"> • Insensitive to environment • Reduced maintenance 	Air technology	Interchangeability ensured with equivalent Circuit-Breaker rating	Interchangeability ensured with equivalent Circuit-Breaker rating

Fuses

Current limiting fuses

Fusarc CF

Solefuse

Tepefuse

MGK



PE60383

Functions

Protection to Medium Voltage distribution devices (from 3.6 to 36 kV) from both the dynamic and thermal effects of short-circuit currents

Rated voltage

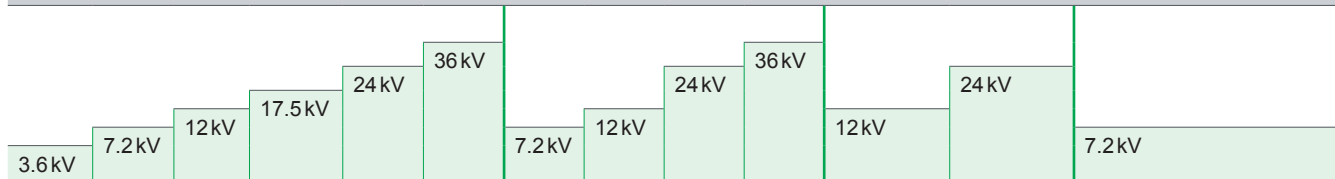

Max. rated current

Up to 200A	Up to 125A	Up to 0.3A	Up to 250A
------------	------------	------------	------------

Max. rated short-circuit current

Up to 63 kA	Up to 50 kA	Up to 40 kA	Up to 50 kA
-------------	-------------	-------------	-------------

Applications

<ul style="list-style-type: none"> • Motors • Power Transformers • Capacitors • Voltage Transformers 	<ul style="list-style-type: none"> • Power Transformers • Capacitors 	Voltage Transformers	Motors
IEC 60282-1, DIN 43625, VDE 0670-402	IEC 60282-1, UTE C64200, C64210	IEC 60282-1, UTE C64200, C64210	IEC 60282-1, UTE standards



Benefits

- High breaking capacity
- High current limitation
- Low I²t values
- Low breaking overvoltage
- Low dissipated power
- For indoor and outdoor applications
- With a thermal striker

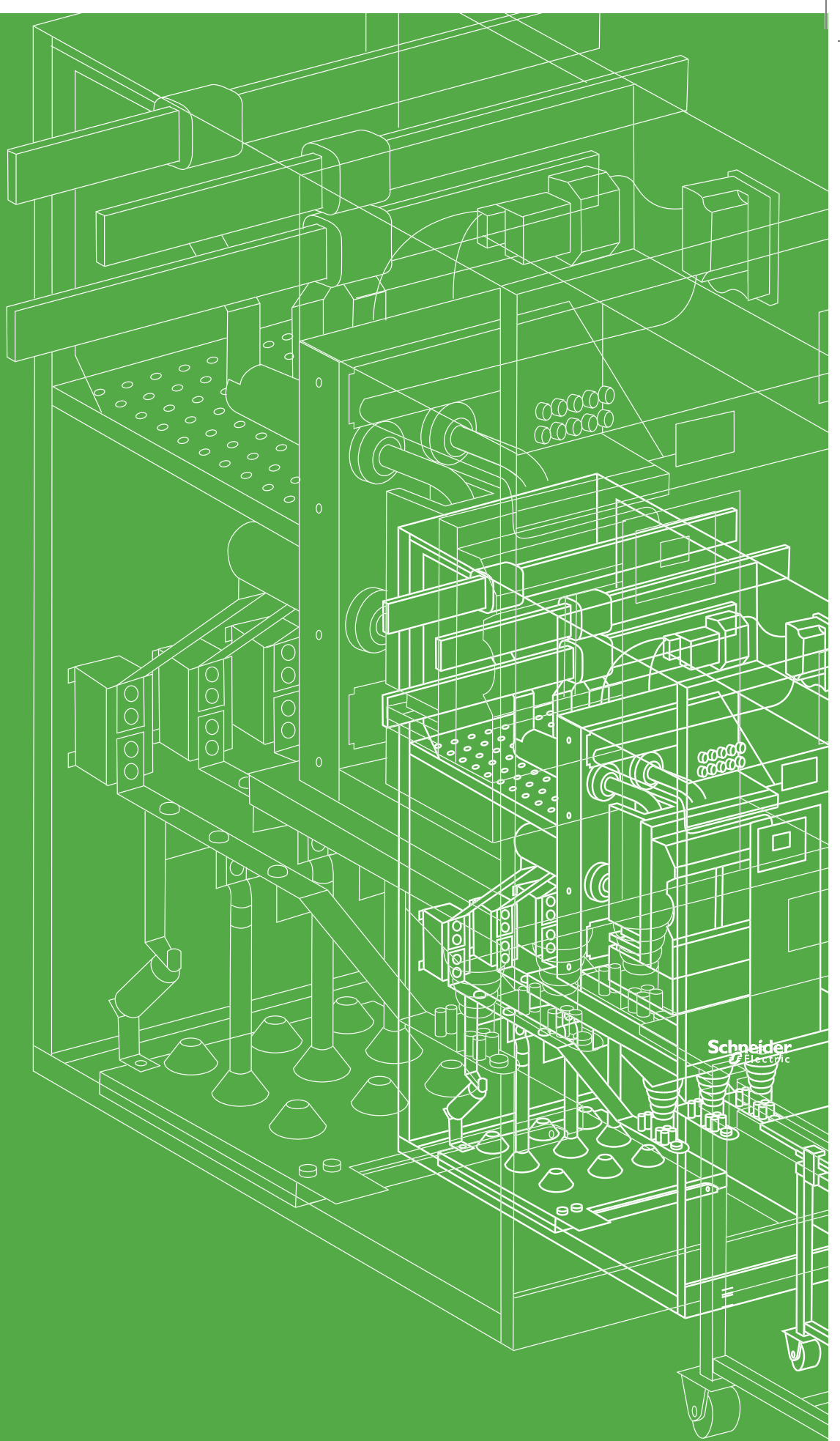





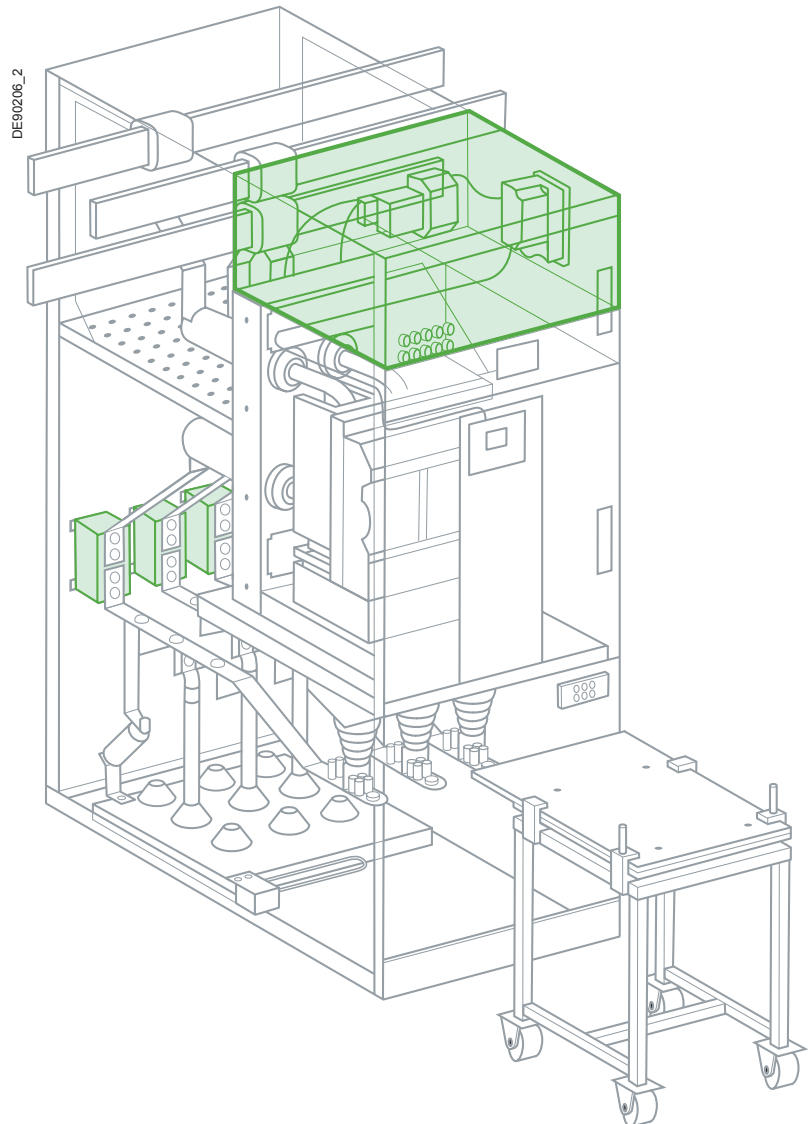

Schneider
Electric



Circuit-Breakers - Contactors - Switches & Disconnectors - Fuses - Protection relays - Arc fault detectors - MV instrument transformers - Energy management & control - LV protection - Direct Current Power supply - LV relays - LV Control & Signalling - Substation remote control and monitoring & Fault indicators - Substation power supply - Capacitors & Power Factor controller - Relay & Switching devices - Accessories

Protection relays	B-2
Arc fault detectors	B-4
Medium Voltage instrument transformers	B-5
Energy management & control	B-6
Low Voltage protection	B-9
Direct Current Power Supply	B-10
Low Voltage relays	B-11
Low Voltage Control & Signalling	B-12
Substation remote control and monitoring & Fault indicators	B-16
Substation power supply	B-17





Protection relays						
Sepam series 10	MiCOM Px10	Sepam series 20	Sepam series 40	Vamp 50 series	MiCOM Px20	
						
Functions						
Provides protection of network for each applications: Substations (incomer or feeder type) / Transformers / Motors / Generators / Busbars / Capacitors (capacitor protection relay page C-3). Each relays serie offers all the functions required for:						
<ul style="list-style-type: none"> • effective protection of life and property • accurate measurements and detailed diagnosis • integral equipment control • local or remote indications and operation 						
Self power / Auxiliary supply						
Auxiliary supply	• Auxiliary supply • Self or Dual supply	Auxiliary supply	Auxiliary supply	Auxiliary supply	Auxiliary supply	
Protection						
Current (1 or 5A)	Current (1 or 5A)	• Current (1 or 5A) • Voltage	• Current (1 or 5A) • Voltage	• Current (1 or 5A) • Voltage	• Current (1 or 5A) • Voltage	
Phase & Earth basic	Phase & Earth basic	Phase & Earth basic	- Phase & Earth basic - Directional	- Phase & Earth basic - Directional	- Phase & Earth basic - Directional	
Display						
Standard UMI	Standard UMI	• Standard UMI • Remote UM	• Standard UMI • Remote UM	Standard UMI	Standard UMI	
Other characteristics						
				Withdrawable hardware	Withdrawable hardware	
Input / Output (up to)						
4 / 7	6 / 6	10 / 8	10 / 8	7 / 5	7 / 8	
I/O terminals						
Screw type	Screw type	• Screw type • Ring lug	• Screw type • Ring lug	Ring lug	Ring lug	
Temperature sensor (up to)						
		8	8 to 16	External RTD input module	10 (motor)	
Communication protocol						
• Modbus RTU • IEC 60870-5-103	• Modbus RTU • IEC 60870-5-103	• Modbus RTU • IEC 60870-5-103 • DNP3 • Modbus TCP/IP • IEC 61850 No GOOSE	• Modbus RTU • IEC 60870-5-103 • DNP3 • Modbus TCP/IP • IEC 61850 No GOOSE • RSTP*	• Modbus TCP / RTU • Profibus DP • IEC 60870-5-101 • IEC 60870-5-103 • IEC 61850 with goose • DNP3 • SPA-bus communication • DeviceNet	• Modbus RTU • IEC 60870-5-103 • DNP3	
Logic equations						
			Comprehensive logic equations		Basic logic equations	
Safety characteristics						
				Arc flash protection		
IEC and specific country standards (UL, CSA, GOST...)	IEC and specific country standards (GOST...)	IEC and specific country standards (UL, CSA, GOST...)	IEC and specific country standards (UL, CSA, GOST...)	IEC and specific country standards (UL, CSA, GOST...)	IEC and specific country standards (UL, CSA, GOST...)	IEC and specific country standards (GOST...)

* Ethernet high availability communication

Sepam series 60	Sepam series 80	MiCOM Px30
 PE90488	 PE90512	 PE90622
Functions		
Self power / Auxiliary supply		
Auxiliary supply	Auxiliary supply	Auxiliary supply
Protection		
<ul style="list-style-type: none"> • Current (1 or 5A or LPCT) • Voltage - Phase & Earth basic - Directional - Synchro-check	<ul style="list-style-type: none"> • Current (1 or 5A or LPCT) • Voltage - Phase & Earth basic - Directional - Synchro-check - Differential	<ul style="list-style-type: none"> • Current (1 or 5A) • Voltage - Phase & Earth basic - Directional - Synchro-check - Differential - Line differential - Distance
Display		
<ul style="list-style-type: none"> • Standard UMI • Remote UM • Mimic based UMI 	<ul style="list-style-type: none"> • Standard UMI • Remote UM • Mimic based UMI 	<ul style="list-style-type: none"> • Standard UMI • Remote UM • Mimic based UMI
Other characteristics		
Removable S/W cartridge	Removable S/W cartridge	
Input / Output (up to)		
28 / 16	42 / 23	50 / 26
I/O terminals		
<ul style="list-style-type: none"> • Screw type • Ring lug 	<ul style="list-style-type: none"> • Screw type • Ring lug 	<ul style="list-style-type: none"> • Screw type • Ring lug
Temperature sensor (up to)		
8 to 16	8 to 16	1/9 / 10
Communication protocol		
<ul style="list-style-type: none"> • Modbus RTU • IEC 60870-5-103 • DNP3 • Modbus TCP/IP • IEC 61850 • Standard GOOSE • RSTP* 	<ul style="list-style-type: none"> • Modbus RTU • IEC 60870-5-103 • DNP3 • Modbus TCP/IP • IEC 61850 • Customized GOOSE • RSTP* 	<ul style="list-style-type: none"> • Modbus RTU • IEC 60870-5-103 • DNP3 • IEC 61850 with GOOSE • RSTP / SHP / DHP*
Logic equations		
Comprehensive logic equations	Control logic by ladder diagram	Comprehensive logic equations
Safety characteristics		
IEC 61508 - SIL2	IEC 61508-SIL2	
IEC and specific country standards (UL, CSA, GOST...)	IEC and specific country standards (UL, CSA, GOST...)	IEC and specific country standards (GOST...)

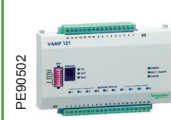

Benefits
Sepam <ul style="list-style-type: none"> • Hardware modularity and common Hardware modules • Large range of auxiliary power • Full range ROHS and conformal coated
MiCOM <ul style="list-style-type: none"> • Complete and Comprehensive product offer • Full IEC 61850 solution with goose • All in the box solution
Vamp 50 <ul style="list-style-type: none"> • Powerful CPU supporting native IEC 61850 • Improved safety with economical and fast arc flash protection

Arc fault detector			
Vamp 120	Vamp 121	Vamp 221 (+I/O units)*	Vamp 321 (+I/O units)*
			

Functions

The arc protection unit detects an arc flash in an installation and trips the feeding breaker. An arc flash protection maximizes personnel safety and minimizes material damage caused by arc faults

System features

<ul style="list-style-type: none"> • Typical operation on light only principle - Input for current criteria for I> & L> operation - Integrated 19 - 256 V AC/DC aux. supply • Optimized for wind power and other small applications • Up to 4 arc or smoke sensors • Selective trip for 2 zones and possibility for generator set emergency trip (separate contact) • Operation time 7 ms (including the output relay) • Non-volatile trip status • NO & NC trip outputs (Zone 1) - Self-supervision - Straight-forward installation - Cost efficient solution 	<ul style="list-style-type: none"> • Operation on light only • Up to 10 sensors arc or smoke sensors • Single trip contact • Straight-forward installation • Operation time 9 ms (including the output relay) • Cost efficient solution • Self-supervision • Binary input for blocking or resetting (programmable) the unit • Possibility for double arc channel activation trip criteria • BIO light transfer possibility to other Vamp device 	<ul style="list-style-type: none"> • Current and light tripping criteria (possibility of tripping by light only) • Operating time 7 ms or less (electromechanical contact) • Accurate location of arc fault utilizing point sensors • Four selective protection zones per central unit • Self-supervision of the entire system • Easy interconnect using VX001 cables • Phase current measuring • Earth fault current measuring • Personal protector option • Panel or rail mount I/O units • Circuit breaker fail protection (CBFP) 	<ul style="list-style-type: none"> • Three phase current, zero sequence voltage and current • Event logs, disturbance recording and real time clock • Operation on simultaneous current and light or light only • Informative display LCD (single line diagram) • Up to ten trip contacts • One normally open and one change over alarm contact • Less than 7 ms operation time (including the output relay) • Optionally 1 ms operation time when semi-conductor outputs are used • Programmable operation zones • Continuous system self supervision • PC configurable • Communication ports supporting a wide range of communication protocols which are intended for a SCADA interface
--	---	---	--

Sensors

<p>Point sensor - surface</p> <ul style="list-style-type: none"> - Arc detection from two compartements simultaneously - Self-monitored - Cable length adjustable from 6m to 20m down 	<p>Point sensor - surface</p> <ul style="list-style-type: none"> - Arc detection from two compartements simultaneously - Self-monitored - Cable length adjustable from 6m to 20m down 	<p>Point sensor - surface</p> <ul style="list-style-type: none"> - Arc detection from two compartements simultaneously - Self-monitored - Cable length adjustable from 6m to 20m down
<p>Point sensor - pipe</p> <ul style="list-style-type: none"> - Self-monitored - Cable length adjustable from 6 to 20m down 	<p>Point sensor - pipe</p> <ul style="list-style-type: none"> - Self-monitored - Cable length adjustable from 6 to 20m down 	<p>Point sensor - pipe</p> <ul style="list-style-type: none"> - Self-monitored - Cable length adjustable from 6 to 20m down
	<p>Portable sensor</p> <ul style="list-style-type: none"> - Snap-in connection to I/O unit - Enhanced work safety 	<p>Portable sensor</p> <ul style="list-style-type: none"> - Snap-in connection to I/O unit - Enhanced work safety
		<p>Loop sensor (fibre)</p> <ul style="list-style-type: none"> - Monitors various compartments - Small bending radius for easy installation

IEC standards	IEC standards	IEC standards	IEC standards
----------------------	----------------------	----------------------	----------------------

* I/O units: 4 ref. available (VAM 3L, VAM 10L/LD, VAM 12L/LD, VAM 4C/CD). The choice is to be made according to the needs of type and number of sensors. Please contact us.



Benefits

- Personnel safety
- Reduces production losses
- Extended switchgear life cycle
- Reduced insurance costs
- Low investment costs and fast installation
- Reliable operation

Medium Voltage instrument transformers

Current Transformers*			Voltage Transformers*		Low Power Current Transformers	
CT			VT		LPCT	
Functions						
For protection or metering purpose					Allows protection and metering in the same product. Both are achieved in the same winding	
Rated voltage						
40.5 kV			40.5 kV		24 kV 0.72 kV	
Max. rated short-circuit current						
60 kA	50 kA	50 kA	50 kA		40 kA	
Max. rated current			Max. rated voltage		Max. rated current	
5000 A	2500 A	2500 A	36 kV		1250 A	2500 A
Technology						
MV insulation technology for MV applications					LV insulation tech. for MV applications	
Main characteristics						
<ul style="list-style-type: none"> PX accuracy class can be respected in accordance to the relay formula. CT types available with primary winding (wounded or bar type) or without primary winding (toroid or window type). Ratio change (tapping) on primary or secondary side according to CT types. 			<ul style="list-style-type: none"> Available types for connection between phases or between phase and earth. Voltage factor 1.9Um x 8h (phase-earth) or 1.2 Um continuously (phase-phase) Rated primary voltage up to 35·√3 kV (phase-earth) or 35 kV (phase-phase) Suitable for applications in earthed or insulated neutral systems. Available types with metal screened surface according to application 		Rated nominal secondary voltage 22.5 mV.	
					Rated nominal secondary voltage 22.5 mV	
Insulation						
Class A (covering and insulation realized by vacuum casting EPOXY resin and APG technology with excellent electrical characteristics, high mechanical strength and high ageing resistance)						
IEC and specific country standards (IEEE, NBR, NFC, GOST...).			IEC and specific country standards (IEEE, NBR, NFC, GOST...).		IEC 60044-8	IEC 60044-8

* Outdoor offer is also available. Please contact us.





Benefits

- Wide range also available following DIN standard
- Lack of emissions of any harmful substances in case of fire

Operating safety: no danger in the event of any accidental opening of the secondary circuit

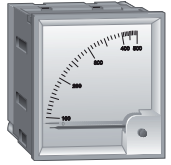

Can be installed in 24 kV, 36 kV or 40.5 kV networks without any specific MV insulation

Energy metering		Power & Energy monitoring		
AMP - ammeter	VLT - voltmeter	PM3255	PM710	PM750
				
Functions				
Measures in amps the current flowing through an electrical circuit <ul style="list-style-type: none"> • Flush mounted 72x72 - 96x96 • 10 A direct current measurement or via external CT • Accuracy: class 1.5 	Measures in volts the potential difference (voltage) of an electrical circuit <ul style="list-style-type: none"> • Flush mounted 72x72 - 96x96 • 600 V AC direct voltage measurement or via external VT • Accuracy: class 1.5 	Offers the basic measurement capabilities required to monitor an electrical installation <ul style="list-style-type: none"> • 5-module case (18 mm modules) • Energy accuracy: IEC 62053-21 class 1 	Offers all the measurement capabilities required to monitor an electrical installation <ul style="list-style-type: none"> • Panel front mounted 96x96 • Energy accuracy: <ul style="list-style-type: none"> - PM710: IEC 62053-21 class 1 - PM750: IEC 62053-22 class 0.5S 	
Instantaneous rms values				
		<ul style="list-style-type: none"> • Current, per Phase & Neutral • Voltage: Total, Phase-to-Neutral and Phase-to-Phase • Frequency • Power factor: Total • Active, reactive, partial active energy • Multi-tariff management 	<ul style="list-style-type: none"> • Current: Total, per Phase & Neutral • Voltage: Total, Phase-to-Neutral and Phase-to-Phase • Frequency • Power factor: Total - Signed • Active, reactive, partial active energy: Signed 	
Power quality measurements				
		THD Current, voltage	Total harmonic distortion: Current, voltage, per phase	
Data recording				
		<ul style="list-style-type: none"> • Min/Max/Demand values • Alarms • Data logging 		<ul style="list-style-type: none"> • Min/Max of instantaneous values • Alarms
Communication				
		<ul style="list-style-type: none"> • Modbus RS485 protocol • 2 digital inputs • 1 digital output 	Modbus RS485 protocol	<ul style="list-style-type: none"> • Modbus RS485 protocol • 2 digital inputs • 1 digital output
Display				
		<ul style="list-style-type: none"> • Backlit LCD • Multi-language HMI 	LCD (features large 11 mm high characters and powerful backlighting for easy reading even in extreme lighting conditions viewing angles)	
IEC 60051-1, IEC 61013-1, IEC 61000-4		IEC 61557-12 PMD/S/K55/1	IEC 62053-21 class 1 IEC 61557-12 PMD/S/K55/1	IEC 62053-22 class 0.5S IEC 61557-12 PMD/S/K55/0.5



Benefits

Local measurements	<ul style="list-style-type: none"> • Panel instrumentation • Sub-billing / cost allocation • Remote monitoring of an electrical installation 	<ul style="list-style-type: none"> • Panel instrumentation • Sub-billing / cost allocation • Remote monitoring of an electrical installation • Harmonic monitoring (THD)
--------------------	---	--

Power & Energy monitoring			Advanced energy metering	
PM820	PM850	PM870	ION7550	ION7650
				
Functions <ul style="list-style-type: none"> • Offers high-performance capabilities needed to meter and monitor an electrical installation • Comprehensive Power Quality Analysis 			<ul style="list-style-type: none"> • Offers unmatched functionality including advanced power quality analysis coupled with revenue accuracy • Flexible architecture for extensive user programmability 	
<ul style="list-style-type: none"> • 96 x 96 mm DIN or Panel mount. RTU, integrated or remote display • Direct connection up to 600 Vac (no PTs) • Built in digital input and output. Additional I/Os optional • Energy Accuracy - ANSI 12.20 Class 0.2 and IEC 62053-23 Class 0.5S 			<ul style="list-style-type: none"> • 192 x 192 mm Panel mount • Five current and four voltage inputs (physical) • I/O options available • Revenue Class 0.2 grade metering 	
Instantaneous rms and energy values			Instantaneous rms and energy values	
Comprehensive RMS values or instrumentation			Advanced RMS values or instrumentation	
<ul style="list-style-type: none"> • Active, reactive, apparent energy • Configurable accumulation mode 			<ul style="list-style-type: none"> • Active, reactive, apparent energy • Configurable accumulation mode 	
Power quality measurements			Power quality measurements	
Individual harmonics (harmonic resolution up to the 63rd) - Current & Voltage			<ul style="list-style-type: none"> • Harmonic resolution up to the 63rd. Interharmonics up to the 50th (ION7650 only) • Individual harmonics - Current & Voltage • Waveform capture of voltage disturbances with disturbance direction detection 	
<ul style="list-style-type: none"> • Waveform capture (PM870: configurable) • EN50160 - ITI(CBEMA)/SEMI F-47 • Power Quality compliance evaluation 			<ul style="list-style-type: none"> • Power quality compliance evaluation • Flicker detection 	
Sag and swell detection				
Data recording			Data recording	
<ul style="list-style-type: none"> • Min/max values with data & event logs • GPS synchronisation • Alarms with e-mail notification 			<ul style="list-style-type: none"> • Min/max values with data & event logs • GPS synchronisation • Alarms with e-mail notification • Trending / forecasting • Memory up to 10 MB 	
Trending / forecasting			Trending / forecasting	
80 kB memory			300 kB memory	
Communication			Communication	
<ul style="list-style-type: none"> • Built in Modbus RS485 • Optional RS232 and second RS485 ports • Optional Ethernet port with gateway functionality and web server 			Extensive communications options and protocols. Serial RS232/485, Optical, Modem and/or Ethernet (gateway and web server) ports, Modbus RTU, DNP 3.0, Modbus TCP/IP, IEC 61850 or ION	
Display			Display	
White backlit LCD display. Intuitive navigation with self-guided, language-selectable menus			Programmable display. Integral LCD or remote color	
ANSI 12.20 Class 0.2, IEC 61557-12, ANSI C37.90.1 Surge Withstand Capability (SWC) and IEC 61000-4-12 Surge Immunity standards + many other international standards			IEEE 519, IEEE 1159, and CBEMA/ITIC	
			IEC 61000-4-30 Class A, IEC 61000-4-7 and IEC 61000-4-15	



Benefits	
<ul style="list-style-type: none"> • For infrastructure, industrial and buildings • Highly accurate • Modular • Energy cost allocation and savings • Energy availability and reliability 	<ul style="list-style-type: none"> • For infrastructure, industrial, buildings and utilities • Revenue metering • Flexible architecture and programmability • Energy savings • Leverage existing infrastructure • Energy availability and reliability

Communication

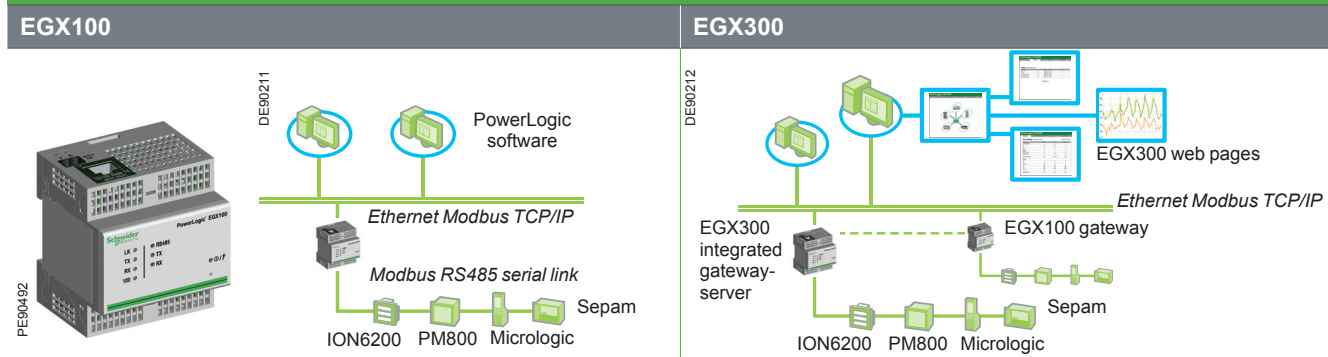

Functions

- | | |
|---|--|
| <p>Ethernet gateway</p> <ul style="list-style-type: none"> • Serves as an Ethernet coupler for PowerLogic system devices and other communicating devices using the Modbus protocol • Offers complete access to status and measurement information provided by connected devices via PowerLogic PC-based software | <p>Web-enabled integrated gateway-server</p> <ul style="list-style-type: none"> • Simplifies power utility monitoring: historical use patterns, which come from real-time electrical system loading data and trend plots, help optimise energy usage and existing electrical infrastructure • Monitors energy usage patterns, reveals opportunities, and helps verify results of efficiency improvements • Remotely monitors real-time conditions and profile energy use on your power distribution system |
|---|--|

DIN rail mounted

Characteristics

- | | |
|---|--|
| <ul style="list-style-type: none"> • Web interface allows for configuration, diagnostics and maintenance • Secure user interface via user name and password • User interface available in English, French, German, and Spanish • Supports serial master to ModbusTCP/IP routing • Advanced security through ModbusTCP/IP filtering with configurable access levels (read-only or full access) • Receives control power through Power over Ethernet (PoE) or 24 Vdc power source • Includes one 10/100Base-Tx Ethernet port • RS485 2-wire and 4-wire compatibility • IP30-rated DIN rail mounted enclosure • Rated for use in industrial environments (-25 to 70°C) | <ul style="list-style-type: none"> • View real-time and historical information from multiple locations via any Microsoft-compatible web browser; no need for additional software • Automatically email or FTP selected logged data to your PC for additional analysis • Select the logging intervals and topics you want logged. • Ensures data and system security through password protection and controlled network access to individual web pages, and allows review of active and historical connections • Receives control power through Power over Ethernet (PoE) or 24 VDC power source • Provides serial support for Modbus RTU, Modbus ASCII, Jbus, and PowerLogic protocols to support a wide range of devices. • Optically isolated serial port provides highly reliable communications in an industrial environment • Includes one 10/100BaseTx Ethernet port • Includes one serial port configurable for RS485 (2-wire or 4-wire) or RS232 (RJ45) • Compatible with all PowerLogic power monitoring software |
|---|--|

Communication





- RS232 or RS485 (2-wire or 4-wire), depending on settings with Modbus RTU/ASCII, PowerLogic (SY/MAX), Jbus protocols
- 10/100 Base TX Ethernet port with HTTP, Modbus TCP/IP, FTP, SNMP (MIB II), and BootP (EGX300 only) protocols
- Web interface for configuration, diagnostics, and maintenance

EN 61000, IEC 60950, UL508/UL60950, CSA C22.2, EN 60950, AS/NZS25 60950, EN55022/EN55011/FCC class A standards



Benefits





- | | |
|---|---|
| <ul style="list-style-type: none"> • Simplifies installation by receiving control power through the Ethernet cable • Set up via an Ethernet network or a serial connection. • TCP/IP filtering security allows you to specify the level of access each master has to connected serial devices • Serial Master Support allows a serial Modbus master device connected to the gateway's serial port to access devices across a TCP/IP network • Compact DIN-rail mounted product | <ul style="list-style-type: none"> • Simplifies installation by receiving control power through the Ethernet cable • Automatically detects networked devices for easy set-up • Allows creation of custom web pages; use web pages to view the real-time and logged data for an at-a-glance view of your energy consumption • Dashboards display energy consumption information aggregated over time • System Access Point shows networked Schneider Electric devices |
|---|---|

Low Voltage protection				
C60N	C60HDC	C60 Electrical auxiliaries		
		OF	SD	
 <p>054047_SE PB100221</p>		 <p>PB104014</p>	 <p>PE90505</p>	 <p>PE90504</p>
Functions				
DIN rail miniature circuit-breakers. Circuit-Breaker used in auxiliary power supply circuits providing overload and short circuit protection		Open/closed contact	Fault signalisation contact	
Rated voltage				
12 to 240 VAC (Ph/N)		250 VDC/pole	<ul style="list-style-type: none"> • 24...415 VAC • 24...130 VDC 	
Number of poles				
1, 2, 3, 4		1 or 2		
Breaking capacity				
10 kA at 240 VAC		6 kA at 250 VDC		
Nominal current		Maximum operating current		
0.5 to 63 A		<ul style="list-style-type: none"> • 6 A at $U \leq 240$ VAC & 3 A at $U \leq 415$ VAC • 6 A at $U = 24$ VDC, 2 A at $U \leq 48$ VDC, 1 A at $U \leq 130$ VDC 		
Type of loads/ Tripping curve*				
B, C, D		C		
Connection				
Screw				
IEC 947-2				
* Tripping Curve C ($5I_n < I_m < 10I_n$) D ($10I_n < I_m < 14I_n$) B ($3I_n < I_m < 5I_n$)		Type of loads Standard Inrush current Electronics or high cable length		



Benefits

The Multi9 circuit-breaker is recognised in over 100 countries for its quality and the breadth of its range, making it an indispensable component for your Low Voltage cabinet with complete peace of mind

Direct Current power supply				
Phaseo				
ABL8REM, ABL7RP	ABL4RS*	ABL4WS*	ABL8RP*	ABL8WP*
				

Functions

The electronic switch mode power supply is designed to provide the direct current voltage necessary for automation system equipment control units

Rated input voltage

100 to 240 VAC	100 to 240 VAC	400 to 500 VAC	100 to 500 VAC	400 to 500 VAC
----------------	----------------	----------------	----------------	----------------

Input type

1 phase	1 or 2 phases	3 phases	1 or 2 phases	3 phases
---------	---------------	----------	---------------	----------

Output voltage and current

<ul style="list-style-type: none"> • 12VDC / 5A • 24VDC / 3A & 5A • 48VDC / 2.5A 	24VDC / 3.5A, 5A, 10A, 20A	24VDC / 20A, 30A, 40A	24VDC / 3A, 5A, 10A, 20A	24VDC / 20A, 40A
---	----------------------------	-----------------------	--------------------------	------------------

Power output

72 to 144 W	85 to 960 W	85 to 960 W	72 to 960 W	72 to 960 W
-------------	-------------	-------------	-------------	-------------

IEC standards	IEC standards	IEC standards	IEC standards	IEC standards
---------------	---------------	---------------	---------------	---------------

* ABL4 and ABL8 only available in some countries



Benefits

Compact size	<ul style="list-style-type: none"> • Compact size • Removable terminals • Diagnosis relay 	<ul style="list-style-type: none"> • Compact size • Diagnosis relay 	<ul style="list-style-type: none"> • Wide input volatge (100 - 500 VAC) • Power boost • Manual or automatic reset mode • Advanced diagnostic 	<ul style="list-style-type: none"> • Power boost • Manual or automatic reset mode • Advanced diagnostic
--------------	--	---	--	--

Low Voltage relays

Electromechanical plug-in relays

Zelio relays

Miniature relays RXM

Universal relays RUM



Functions

Designed for the adaptation, amplification, multiplication and processing of information in automated system

Switching voltage

12/250 VAC/DC

Number of contacts

2, 3 or 4 CO

2 or 3 CO

Current

6 - 10 - 12A

10A

Mounting





Plugs into socket (DIN rail)

IEC 61984-1



Benefits

- Wide choice of number of contacts (up to 4)
- Simplicity of installation and maintenance
- Standardisation of relay pin arrangement on its socket.
- "Test" button for checking the relay functions, even in a remote enclosure
- Clear indication: contact status mechanical indicator and "Relay On" @LED indicator
- Suitable input/output currents and switching voltages





Pushbuttons & Switches				
ZB6/XB6	XB7	ZB5/XB5	ZB4/XB4	K1/K2
				
Functions				
Enables operation of the Low Voltage circuits of the Medium Voltage cubicle				
Mounting hole (mm)				
16	22			16/22
Material				
Plastic			Metallic	Plastic or metallic
Head shape				
● ■ ■■	●	● ■	●	■
Composition type				
Modular	Unibody	Modular		
Panel fixing with				
Plastic nut			3 points metal	Plastic nut or 4 screws
Degree of protection				
IP 65	IP 65	IP 66	IP 66	IP 40 / IP 65
Rated insulation voltage				
250 V	250 V	600 V	600 V	690 V
UL/CSA, IEC	UL/CSA, IEC	UL/CSA, IEC, CCC, GOST	UL/CSA, IEC, CCC, GOST	UL/CSA, IEC



Benefits

- Easy to select and to install
- A wide choice of functions
- Robustness & mechanical durability
- High protection degree
- Excellent aesthetics and ergonomics

Illuminated Pushbuttons, Pilot lights & Switches

XVL	ZB6/XB6	XB7	ZB5/XB5	ZB4/XB4
				
Functions				
Provides status information and enable control of Low Voltage circuits				
Mounting hole (mm)				
8/10/12	16	22		
Material				
Plastic				Metallic
Head shape				
●	● ■ ■	●	● ■	●
Composition type				
Unibody	Modular	Unibody	Modular	
Panel fixing with				
Plastic nut				3 points metal
Degree of protection				
IP 40 / IP 65	IP 65	IP 65	IP 66	IP 66
Rated insulation voltage				
50 V	250 V	250 V	600V max	600V max
UL/CSA, IEC	UL/CSA, IEC	UL/CSA, IEC, CCC, GOST	UL/CSA, IEC, CCC, GOST	UL/CSA, IEC, CCC, GOST



Benefits



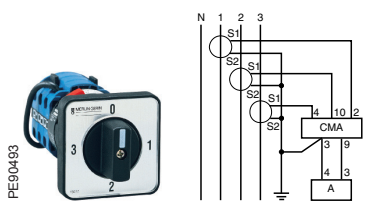
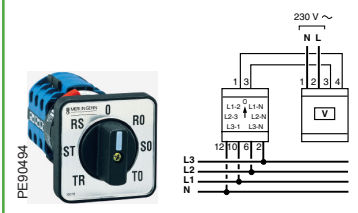

- Long life resistance (LED technology)
- True colours and excellent brightness
- A wide choice of voltages
- High protection degree
- Easy mounting

Low Voltage Control & Signalling

Selector switches	
CMA	CMV
	
Functions	
CMA uses a single ammeter (by means of Current Transformers) for successive measurement of the currents of a three-phase circuit	CMV uses a single voltmeter for successive measurement of voltages (phase-to-phase and phase-to-neutral) of a three-phase circuit
48 x 48 Flush mounted	48 x 48 Flush mounted
Mechanical switching cycles	
2 000 000	
Electrical switching cycles	
100 000	
Max. rated voltage	
500 V	
Max. rated current	
20A	
IEC 60947-3	

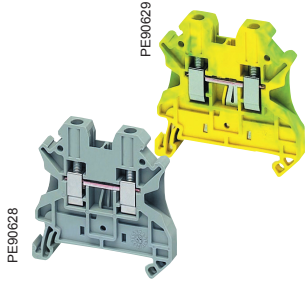
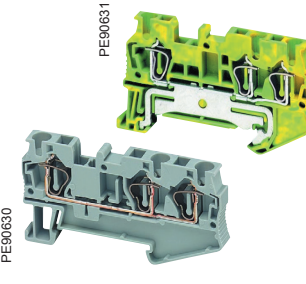
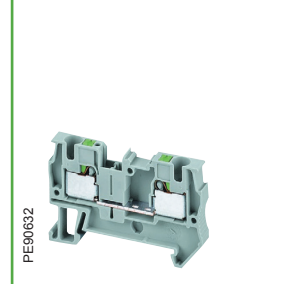
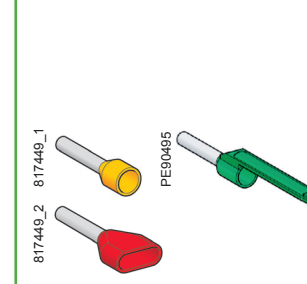





Benefits
<ul style="list-style-type: none"> • AgNi contact ensuring mechanical durability • IP65 on front face

New Linergy TR - Terminal Blocks*			Cable Ends
NSY TRV	NSY TRR	NSY TRP	DZ5 / AZ5
			
Functions			
Ensures connection of Low Voltage cables or wires			<ul style="list-style-type: none"> Facilitates the insertion of wires into the terminals and assures the insulation between adjacent connection Allows the identification of the wires
Technology			
Screw clamp technology	Spring clamp technology	Push-in technology	Insulated cable ends
Connection functions			
<ul style="list-style-type: none"> Passthrough (2.5 - 250 mm²) Protective earth Disconnect type (blade or fuse) Double deck, multi-pole Multifunction Neutral disconnect 	<ul style="list-style-type: none"> Passthrough (2.5 - 16 mm²) Protective earth Disconnect type (blade or fuse) Double deck, multi-pole 	<ul style="list-style-type: none"> Passthrough (1 - 2.5 mm²) Protective earth Disconnect type (blade or fuse) Double deck, multi-pole 	Three available versions: <ul style="list-style-type: none"> Single conductor cable ends Single conductor markable cable ends Twin conductor cable ends
Conductor nominal c.s.a. (cross section area)			
2.5mm ² to 240mm ²	2.5mm ² to 16mm ²	2.5mm ² and 4mm ²	0.25mm ² to 50mm ²
Number of poles			
1 - 1 x 1 / 1 - 2 x 2 2 - 1 x 1 / 3 - 1 x 1	1 - 1 x 1 / 1 - 1 x 2 / 1 - 2 x 2 2 - 1 x 1 / 2 - 1 x 2 / 3 - 1 x 1	1 - 1 x 1 / 1 - 1 x 2 / 1 - 2 x 2 2 - 1 x 1 / 2 - 1 x 2 / 3 - 1 x 1	
Clip-on mounting on rail type			
			
UL, CSA, VDE, ATEX	UL, CSA, VDE, ATEX	UL, CSA, ATEX	UL, CSA

* available from January 2013



Benefits			
Rugged and reliable This technology not only provides quality, safety and availability of equipment but optimizes installation setup and operation with their simple integrated functions	Cost effective (quick and reliable) Spring technology is a maintenance-free connection method assuring separation of mechanical and electrical functions. It also eliminates the need for regular re-tightening	Quick and innovative Solid conductors or conductors with cable-ends can be directly inserted into the terminal block without tools. The actuation lever can be operated with any tool for loosening conductors	Fast and reliable wiring Don't forget the AZ5 and DZ5 ranges of cable ends to simplify wiring and provide optimum electrical continuity between wire and terminal block.

Substation remote control and monitoring units		Fault Passage Indicators (FPI)	
Easergy		Easergy	
T2001	Flair 200C	Flair 21D-22D-23D-23DM*	Flair 219-279
			
Functions		Functions	
<ul style="list-style-type: none"> Provides switch remote monitoring and control Option for Automatic Transfer System (ATS) using Voltage Presence Information from VD23 (see D-2) 	<ul style="list-style-type: none"> Provides remote access to fault detection and data monitoring of the substation 	<ul style="list-style-type: none"> Provides phase and earth fault local indication 	
<ul style="list-style-type: none"> Capacity: 1-16 switches Battery autonomy: 16 h Fault indicator: phase and earth fault Uninterruptible power supply: 24 or 48 Vcc Option for IEC 61131 programming languages to develop automation functions 	<ul style="list-style-type: none"> One or two Fault Indicators: phase and earth fault for all types of neutral arrangement Integrated functions of measurement and monitoring of the substation and data transmission Option for IEC 61131 programming languages to develop automation functions 	<ul style="list-style-type: none"> Ammetric FPI, self powered by measurement sensors, integrated in MV switchgear or in wall-mounted box 	<ul style="list-style-type: none"> Ammetric FPI, powered by LV supply and/or battery, wall-mounted installation
Protocols		Detection	
IEC 870-5-101 and 104, DNP3/DNP3 IP, Modbus/Modbus TCP and various customer owned protocols		Phase and earth fault	
Transmission systems		Setting	
<ul style="list-style-type: none"> Ethernet, RS232/485, radio, PSTN, GSM, GPRS Periodic call management Concentration of Modbus slave devices Embedded web server Local and remote configuration 		By dip switches or menu on LCD display	By dip switches
IEC standards		Installation	
IEC standards		Embedded in the switchgear	Wall mounted
IEC standards		Earthing system	
IEC standards		Direct, impedant, compensated, isolated	
IEC standards		Supply	
IEC standards		Self powered by current sensor (+ Li battery on Flair 22D)	<ul style="list-style-type: none"> Flair 279: 230V AC + Li battery Flair 219: Li battery
IEC standards		Measurement	
IEC standards		<ul style="list-style-type: none"> Ammeter Maxmeter 	
IEC standards		Communication	
IEC standards		<ul style="list-style-type: none"> Dry output contact (Flair 21D-22D-23D) Modbus RS485 (23DM) 	Dry output contact

* available from April 2013



Benefits

<ul style="list-style-type: none"> All-In-One device: <ul style="list-style-type: none"> - reliability - single configuration and diagnostic tool 	<ul style="list-style-type: none"> All-In-One device: <ul style="list-style-type: none"> - reliability - single configuration and diagnostic tool - Opens the door to the most advanced Smart grid monitoring needs 	<ul style="list-style-type: none"> Easy commissioning Highly configurable Long life time Measurement functions included Advanced fault detection features 	<ul style="list-style-type: none"> Configurable fault detection settings Ten years life time battery
---	--	--	--

Substation power supply

Easergy

PS100



Functions

The PS100 associated with a back-up battery ensures the uninterrupted power supply up to 48 hours in the event of micro-outage and power interruptions for:

- MV switchgear electrical mechanism (motors and coils)
- Transmission equipment (e.g. radio)
- Protection relays , Fault passage indicators or others IEDS
- And all others devices in MV/LV substations (Low Voltage breakers, PLC concentrator..)

Power supply outputs

- 12VDC - 100W/20s (for modem, radio, RTU, etc) and 18W permanent
- 48VDC or 24VDC - 300W/ 1 minute (for switchgear operating mechanism motors) and 90W permanent (for protection relays, electronic devices, etc)

Protocols

Modbus

IEC 60255-5 (10 kV level) standard



Benefits

Specifically designed for MV/LV substations, provides supplies with appropriate characteristics for:

- Transmission equipment such as radios
- Control units such as Remote Terminal Units (RTU) or Automatic Transfer Systems (ATS)
- Protection relays, Fault Passage Indicators and other Intelligent Electronic Devices (IED)

High availability:

- Robustness to the environment of a substation (10 kV insulation, -40° C + 70° C operating temperature)
- Additional "energy back-up" to restart the installation after a prolonged network cut
- Modbus communication port forwards monitoring data to allow optimized maintenance operations
- Limitation, dedicated to radio units, to avoid the battery discharge

Power Factor Correction components

Energy efficiency with Power Factor Correction

Most utilities have specific policies for billing reactive energy. Price penalties are applied if the active power / apparent power ratio is not within the guidelines.

Power Factor Correction solutions modify and control the reactive power to avoid utility penalties, and reduce overall kVA demand.

These solutions result in lowering utility power bills by 5 to 10%.

*Circuit-Breakers - Contactors - Switches & Disconnectors - Fuses - Protection relays - Arc fault detectors - MV instrument transformers - Energy management & control - LV protection - Direct Current Power supply - LV relays - LV Control & Signalling - Substation remote control and monitoring & Fault indicators - Substation power supply - **Capacitors & Power Factor controller** - **Relay & Switching devices** - Accessories*



Capacitors & Power Factor controller

C-2

Relay & Switching devices

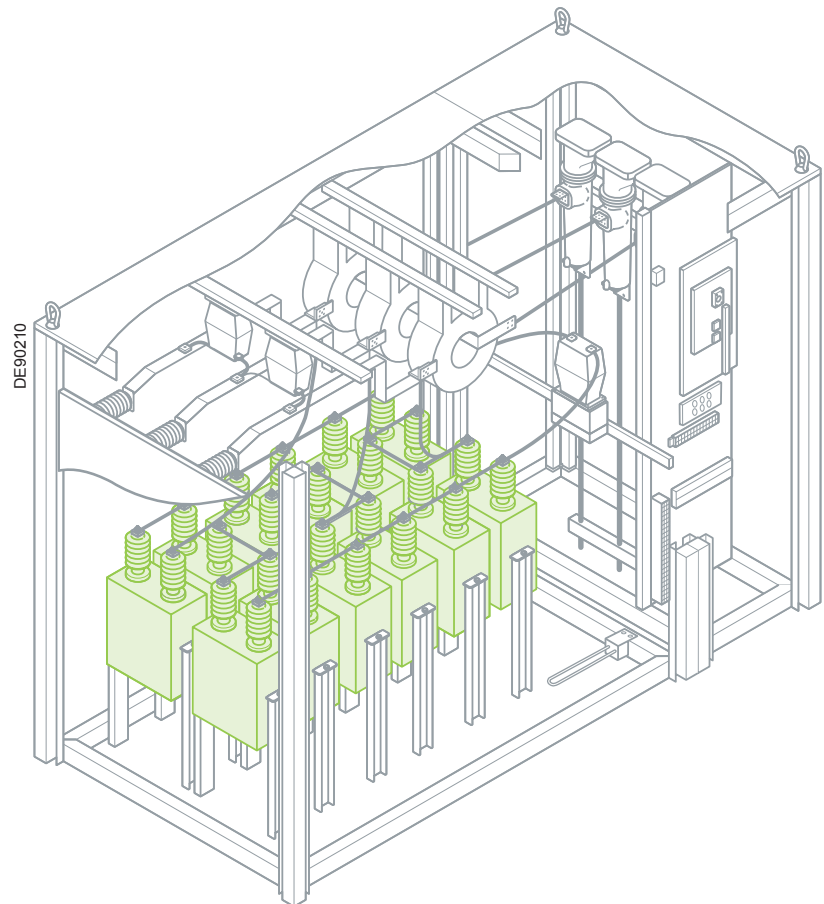
C-3



Capacitors		Power Factor controller	
Propivar NG		Varlogic NR6 - NR12 - NRC12	
 <p style="font-size: small;">PE90516</p>		 <p style="font-size: small;">PB10032_SE</p>	
Functions			
<p>Propivar capacitors are used to build capacitor banks for power factor correction on medium voltage networks</p>		<p>Measures the reactive power of the installation and control connection and disconnection of capacitor steps in order to obtain the required power factor</p>	
Maximum Voltage Um (kV)			
7.2kV	12kV	17.5kV	24kV
			36kV
		<ul style="list-style-type: none"> • NR6 - Control up to 6 capacitor steps • NR12 - Control up to 12 capacitor steps • NRC12 - Control up to 12 capacitor steps and offer some more functions and Modbus 	
Basic Impulse Level (BIL) (kV peak)			
60	75	95	125
			170
Technical specifications			
<p>They allow by their different assembly combination to cover many power ratings depending on the insulation voltage, frequency and harmonic pollution level of the network</p> <ul style="list-style-type: none"> • Single capacitor • 3 phase capacitor • Surge protection • Double capacitor unit 		<ul style="list-style-type: none"> • Panel mounting on 35 mm DIN rail (EN 50022). • Insensitive to phase rotation polarity. • Direct display of network and capacitor bank step characteristics • Automatic programming and commissioning • Communication option Modbus RS485 network 	
Maximum nominal reactive power			
900 kvar (1p) - 600 kvar (3p) - 800 kvar (double capacitor unit)			
IEC 60871-1, 2 & 4, NEMA CP1.		IEC 61326 (CEM), IEC 61010-1/ EN 61010-1 standards	
Other standards on request			



Benefits	
<ul style="list-style-type: none"> • Safety: all Propivar NG capacitors are type tested • Reliability: 30 years design life • Green: no PCB ; full compliance with ROHS directive 	<ul style="list-style-type: none"> • Simplification of the installation, supervision and maintenance of reactive power compensation equipment • Intuitive man/machine dialogue



Switching devices adapted to capacitor applications

Circuit - Breakers

- SF1 & SF2
- HVX

Contactors

- Rollarc
- CBX (specific version)
- CPX (specific version up to 3.6 kV)

Protection relays

Sepam series C86



Fonction

Protection relay dedicated to capacitor application

Self power / Auxiliary supply

Auxiliary supply

Protection

- Current (1 or 5A or LPCT)
- Voltage

- Phase & Earth basic

- Directional
- Synchro-check
- Differential

Display

- Standard UMI
- Remote UM
- Mimic based UMI

Other characteristics

Removable S/W cartridge

Input / Output (up to)

42 / 23

I/O terminals

- Screw type
- Ring lug

Temperature sensor (up to)

8 to 16

Communication protocol

- Modbus RTU
- IEC 60870-5-103
- DNP3
- Modbus TCP/IP
- IEC 61850
- Customized GOOSE
- RSTP*

Logic equations

Control logic by ladder diagram

Safety characteristics

IEC 61508 - SIL2

IEC standards

* Ethernet high availability communication



Benefits

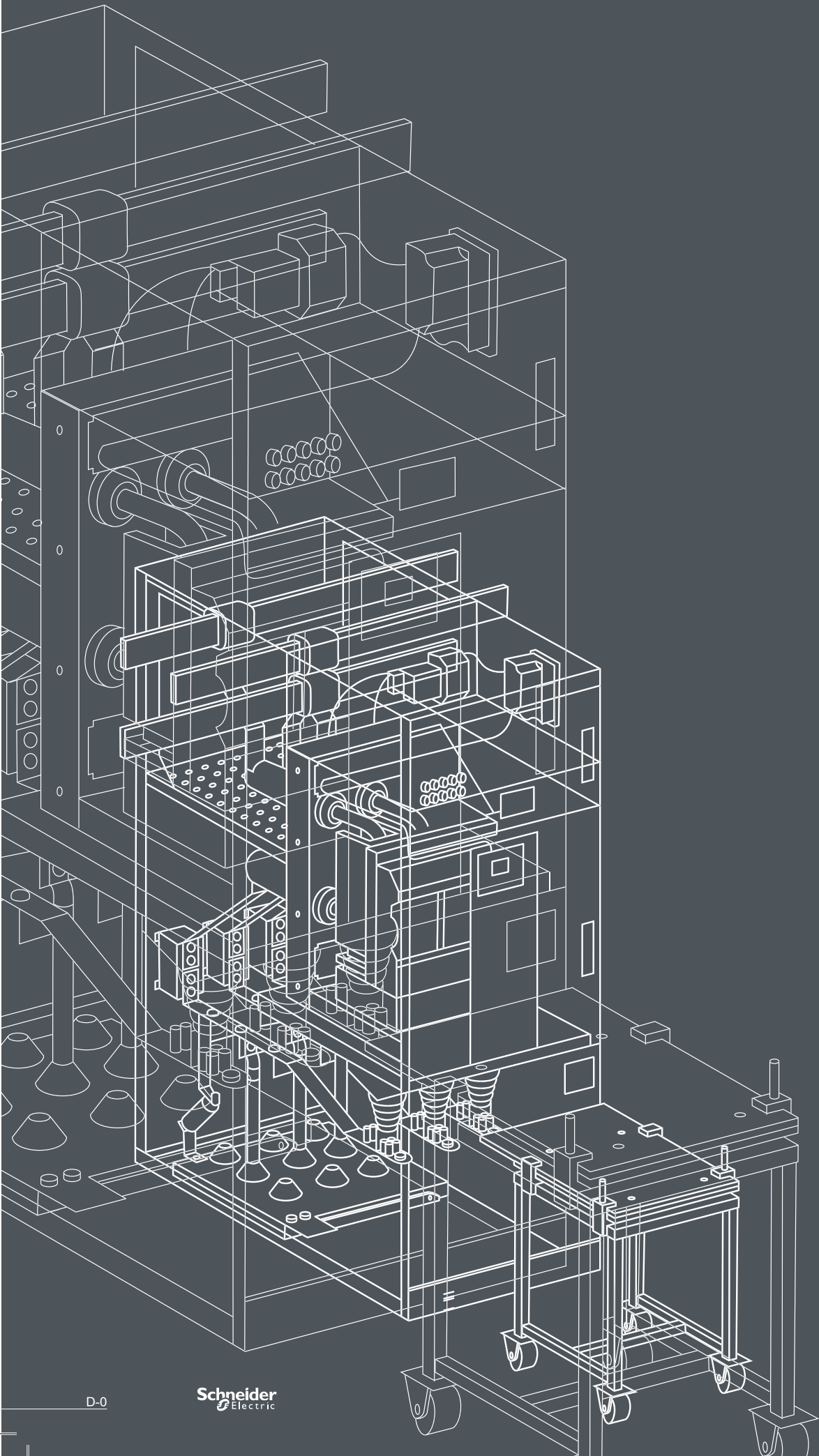

- Compliance with RoHS European directive
- Low Energy consumption

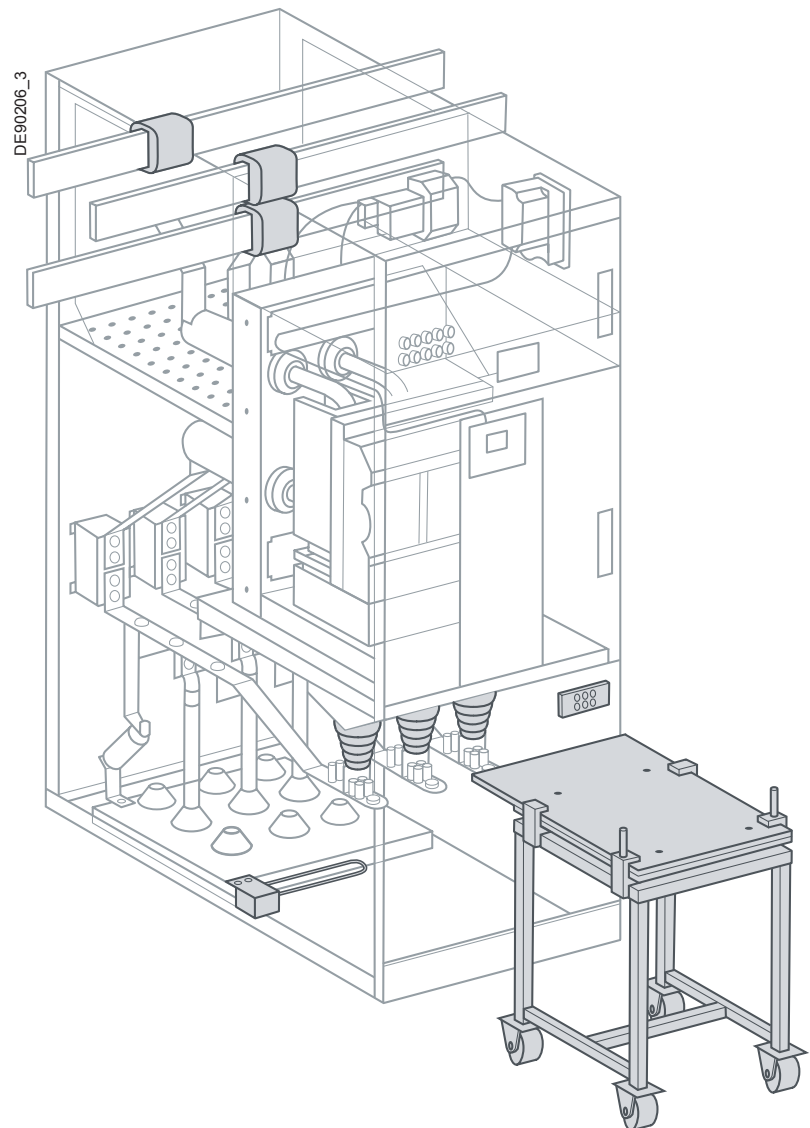

*Circuit-Breakers - Contactors - Switches & Disconnectors - Fuses - Protection relays - Arc fault detectors -
MV instrument transformers - Energy management & control - LV protection - Direct Current Power supply
- LV relays - LV Control & Signalling - Substation remote control and monitoring & Fault indicators -
Substation power supply - Capacitors & Power Factor controller - Relay & Switching devices - Accessories*

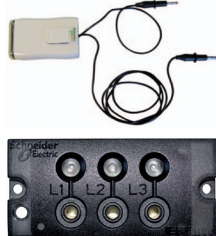

Accessories

Accessories					
Sepam 100MI	VPIS V2 and phase concordance unit	VD23	Insulating holder w or w/o capacitive divider		
					
Functions	<ul style="list-style-type: none"> Module with animated mimic diagram and selector switch/ pushbutton for local or remote control, showing the cubicle single line diagram with devices symbolized 	<ul style="list-style-type: none"> Self-powered Voltage Presence Indicating System Including voltage output version (VPIS-VO) for connection to a VD23 Voltage presence relay Needs Phase Concordance Unit for Phase concordance checking 	<ul style="list-style-type: none"> Indicates presence or absence of voltage through 1 or 2 relays For MV networks from 3 kV to 36 kV Associated with VPIS-VO 		
Technical specifications	<ul style="list-style-type: none"> Without capacitive divider: provides mechanical support and insulation through their rigid fin arrangement; used to support busbars and cable ends With capacitive divider: provides mechanical support and insulation. The embedded capacitors in this insulating holder provide voltage output to indicate the voltage presence, up to 24 kV 	<ul style="list-style-type: none"> Available in 14 standards types 21-pin connector on the back for the connection of <ul style="list-style-type: none"> supply voltage device position indication output circuit breaker control (open/ close and disconnect) outputs. Power supply: 24 to 127VAC/DC 	<ul style="list-style-type: none"> Connectors on the front panel allowing to use a Phase Concordance Unit Light indication using LEDs Made in 2 parts: surge protection part, always connected and Voltage presence indication part, replaceable for maintenance 	<ul style="list-style-type: none"> Self-adapted to network Voltage Displays the voltage in % of nominal Output contacts behaviour configurable according to various combinations of phase and unbalance voltage status DIN format Allows to address various applications: <ul style="list-style-type: none"> Automatic transfer systems Alarms on voltage loss Automation on voltage loss Earth locking on voltage presence Alarms on voltage presence 	<ul style="list-style-type: none"> Height: 175 mm Capacitive divider: ISO 35 pf
Reference numbers	<ul style="list-style-type: none"> Each module is suited to a particular indication and local control application chosen according to: <ul style="list-style-type: none"> Cubicle single-line diagram Devices whose positions are to be indicated Required local control functions 	<ul style="list-style-type: none"> 4 versions according to voltage ranges: <ul style="list-style-type: none"> VPI624x3 (2kV-4kV) VPI624x4 (3kV-6.3kV) VPI624x7 (9kV-17kV) VPI624x8 (13kV-25kV) with 2 ref. for each version: <ul style="list-style-type: none"> x=0 for VPIS x=1 for VPIS-VO Phase concordance unit: VPI62421 	<ul style="list-style-type: none"> Voltage presence relay (VD23): ref. EMS58421 Combined voltage presence relay + Fault Passage Indicator (Flair 23DV): ref. EMS58353 	<ul style="list-style-type: none"> 3 isolateurs standards : <ul style="list-style-type: none"> 17.5 kV ref. 59431 24 kV ref. AAA10075 3 isolateurs avec diviseurs capacitifs : <ul style="list-style-type: none"> 17.5 kV ref. 59430 24 kV ref. AAA10074 	
IEC standards	IEC 62271-206	IEC standards	IEC standards		
Benefits	<ul style="list-style-type: none"> Includes all the animated mimic elements for viewing, breaking and disconnection devices status Compact size and easy installation Reduced cabling Stand-alone or with Sepam 	<ul style="list-style-type: none"> High reliability thanks to: <ul style="list-style-type: none"> Harsh environment design LED indication: extended life time 	<ul style="list-style-type: none"> Fits all MV network neutral systems Compact (DIN format) Output contact behaviour highly configurable according to configuration needs 	<ul style="list-style-type: none"> Dielectric withstand Mechanical robustness 	

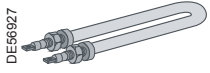
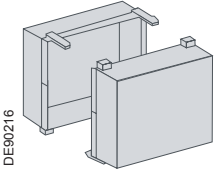
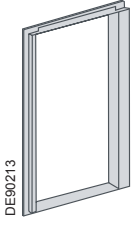
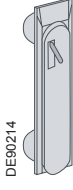
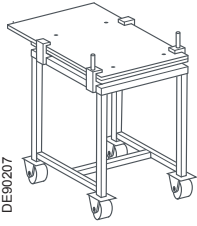
Accessories				
Anti-condensation Heating element	Insulation busbar cover	High resistance plastic window	Cubicle compartment handle	Extraction table
 DE66927	 DE60216	 DE90213	 DE90214	 DE90207
Functions				
Heating the inside of the cubicle when the ambient temperature is too low	Set of 3 insulating covers which enables improved dielectric withstand at the busbars connections in the cubicle	Located on the panel or the door, allows you to see inside a cubicle	Enables the front panel door of the cubicle to be closed.	Enables the circuit-breaker to be taken out of the cubicle and handled during maintenance operations or cubicle manufacturing
Technical specifications				
<ul style="list-style-type: none"> • 220 V AC • 150 W • Length: 432 mm • Supplied with its support without thermostat 	For 1 to 4 busbars (100 mm x 800 mm each)	<ul style="list-style-type: none"> • 3 mm thick transparent Polycarbonate window • Dimensions: 138 mm x 85 mm 	<ul style="list-style-type: none"> • Material: Zamak • A version with key is available 	<ul style="list-style-type: none"> • Height adjustment up to 250 mm • A latching device is provided between the extraction table and the cradle
Reference numbers				
59280	59420	59105	<ul style="list-style-type: none"> • 59270 (handle) • 59271 (handle with key) 	<p>Available for respective circuit-breakers ranges.</p> <ul style="list-style-type: none"> • For Evolis: <ul style="list-style-type: none"> - 59130 (full extraction table) - 59129 (top tray of the table + full device drawings for local manufacturing) • For other circuit-breakers, please contact us



Benefits				
Avoid condensation in the cubicle	Can be adjusted according to number of busbars	Internal arc withstand up to 31.5 kA	Robustness	Possibility to manufacture locally the table support frame

Components for Medium Voltage cubicles

Component panorama for panel builders

"The widest range to meet all your requirements"

All useful documents are available through
www.schneider-electric.com

Schneider Electric Industries SAS

35, rue Joseph Monier
CS 30323
F-92505 Rueil-Malmaison cedex (France)
Tel.: +33(0)1 41 29 70 00
RCS Nanterre 954 503 439
Capital social 896 313 776 €
www.schneider-electric.com

NRJED111211EN-V2

As standards, specifications and designs change from time to time, please ask for confirmation of the information given in this publication.

Published by: Schneider Electric
Produced by: SYNTHÈSE ECA



*This document has been
printed on ecological paper.*

10/2012